

**KANSAS DEPARTMENT OF TRANSPORTATION
SPECIAL PROVISION TO THE
STANDARD SPECIFICATIONS, EDITION 2015**

Add the following to SECTION 805:

WORK ZONE TRAFFIC CONTROL AND SAFETY

Traffic Control Type: Flagger or Pilot Car

Provide, erect, and maintain all traffic control devices required by the Contract Documents according to the details shown on the applicable **Standard Plan Sheets: TE700, TE702, TE704, TE705, TE710, TE712, TE720, and TE730 or TE731.**

Traffic Control Type: Temporary Signals (To control two way traffic on one lane)

Provide, erect, and maintain all traffic control devices required by the Contract Documents according to the details shown on the applicable **Standard Plan Sheets: TE700, TE702, TE704, TE705, TE710, TE712, TE720, TE730 or TE731, TE732, TE733 and TE734.**

Traffic Control Type: 4 Lane Highway with Crossover and Head to Head Traffic

Provide, erect and maintain all traffic control devices required by the Contract Documents according to the details shown on the applicable **Standard Plan Sheets: TE700, TE702, TE704, TE705, TE710, TE712, TE722, TE744, and (TE740 or TE742) or TE748.**

Traffic Control Type: 4 Lane Highway with Construction Traffic Using Median Break

With the permission of the Engineer, construction equipment may use the median crossovers. Provide, erect and maintain all traffic control devices required for the median crossovers that complies with the attached sheet and the applicable **Standard Plan Sheets: TE700, TE702, TE704, TE710, and TE712** at no cost to the KDOT.

NOTE: The only change is TE795 was removed from the packet, because it will be filled out individually and added to the project as needed.

02-01-16 TST (KRE)
Mar-16 Letting

The selected crossover should not be within 1/2 mile of the advanced signing of the work.
 Contractor's construction equipment will not be allowed to use any median crossover within one mile of an interchange.
 Vehicles not associated with construction/maintenance shall not be allowed to use the crossover median.

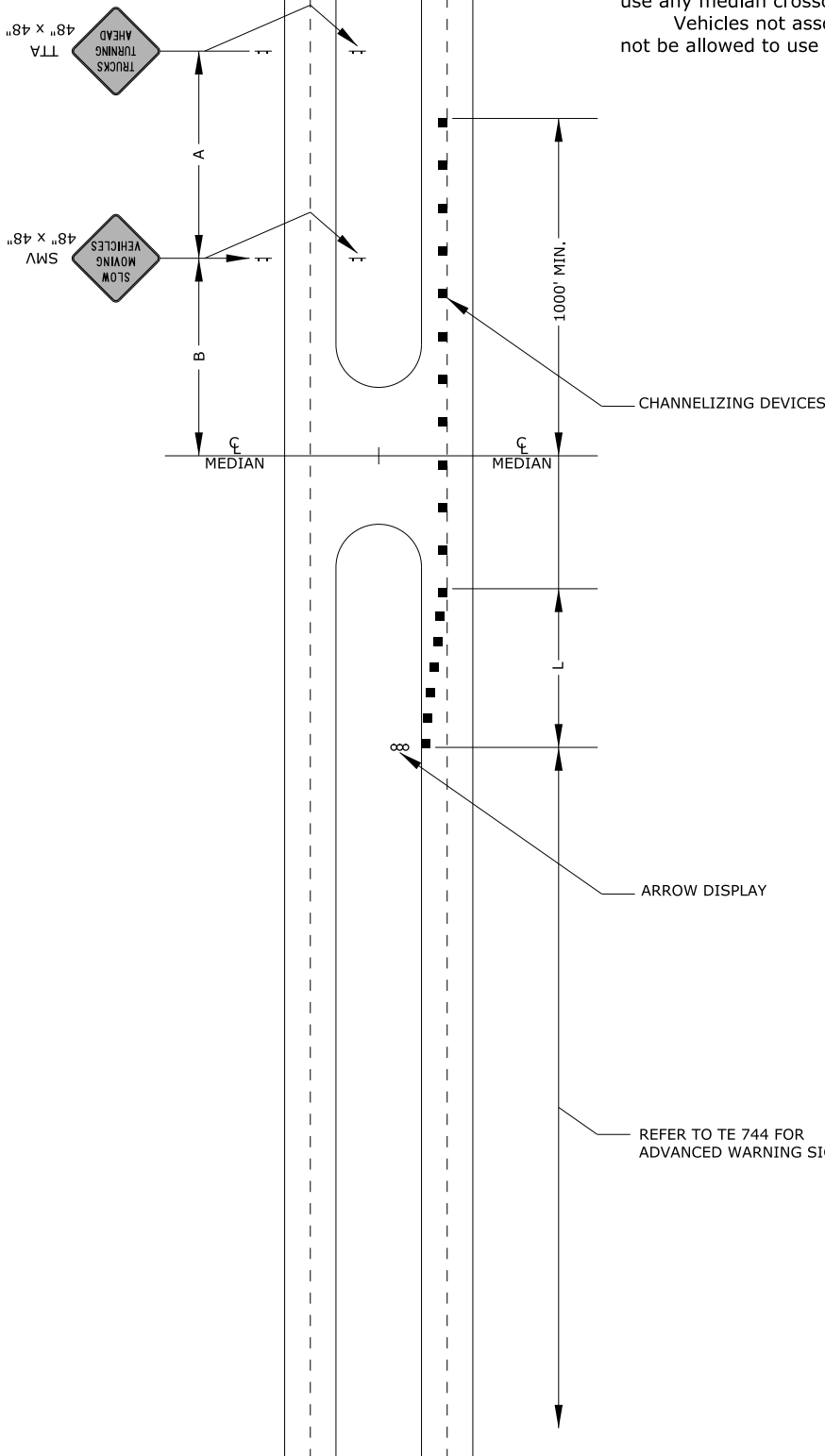

48.00" across sides 3.75" Radius, 0.88" Border, 0.63" Indent, Black on Fluorescent orange;
 [SLOW] C; [MOVING] C; [VEHICLES] C;
 Table of distances between letter and object lefts.

S	L	O	W	M	O	V	I	N	G	V	E	H	I	C	L	E	S
22.16	5.30	4.68	5.23	5.25	22.16												
18.25	6.01	5.23	5.45	2.46	5.30	3.83	18.25										
14.34	5.45	4.68	5.30	2.46	5.01	4.68	4.69	3.82	14.35								

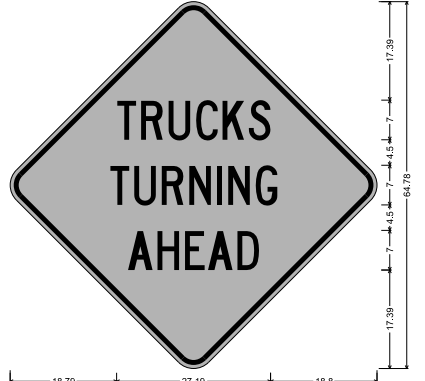

48.00" ACROSS SIDES 3.75" RADIUS, 0.88" BORDER, 0.63" INDENT, BLACK ON FLUORESCENT ORANGE;
 [TRUCKS] C; 70% SPACING; [TURNING] C; 70% SPACING;
 [AHEAD] C; 70% SPACING;
 TABLE OF DISTANCES BETWEEN LETTER AND OBJECT LEFTS.

T	R	U	C	K	S	T	U	R	N	I	N	G	A	H	E	A	D
18.79	4.33	4.86	4.86	4.66	4.65	3.83	18.80										
17.58	4.33	4.86	4.86	2.02	4.86	3.82	17.59										
20.81	5.21	4.86	4.05	5.20	3.83	20.82											

- CHANNELIZING DEVICE
- ∞ ARROW DISPLAY
- TYPE "A" LOW INTENSITY WARNING LIGHT

3					KANSAS DEPARTMENT OF TRANSPORTATION
2					FHWA APPROVAL
1					APP'D Kristina Ericksen
NO.	DATE	REVISIONS	BY	APP'D	DESIGNED Robert Bartron

1) Design Speed: Those items delegated to temporary traffic control should be designed and installed using the posted/legal speed of the roadway prior to work starting.

2) Minimum lane width: Lane widths shall be a minimum of 11' (measured between centerlines of pavement markings) or as shown on the plans, or as directed by the engineer. A lane width less than 11' may require restricted roadway width signing.

3) Consideration should be made to separate pedestrian and, if needed, bicycle movements from both work site activity and vehicular traffic. Unless a reasonable safe route that does not involve crossing the roadway can be provided, pedestrians should be appropriately directed with advance signing that encourages them to cross to the opposite side of the roadway. In urban and suburban areas with high vehicular traffic volumes, these signs should be placed at intersections (rather than midblock locations) so that pedestrians are not confronted with midblock work sites that will induce them to attempt skirting the work site or making a midblock crossing.

4) When existing pedestrian facilities are disrupted, closed, or relocated, the temporary facilities shall be detectable and include accessibility features consistent with the features present in the existing pedestrian facility.

5) When the driving surface open to traffic is milled, is a temporary surface made of loose material, or when directed by the engineer use the W8-15 (Grooved Pavement) or W8-7(Loose Gravel) a "C" distance after the W20-1 (Road Work Ahead) on mainline approaches. Signs may be used with the W8-15p motorcycle plaque as directed by the engineer. Display signs in advance of the condition as long as the condition is present.

6) Alternative temporary rumble strip options may be available. Please contact the Temporary Traffic Control Unit for more information at 785-296-0355 or 785-296-1183.

3					KANSAS DEPARTMENT OF TRANSPORTATION
2					FHWA APPROVAL 08/18/15
1	08/18/15	Channellizer spacing Info	R.W.B.	K.E.	APP'D Kristina Ericksen
NO.	DATE	REVISIONS	BY	APP'D	DESIGNED Robert Bartron

TRAFFIC CONTROL
GENERAL NOTES
TITLE LINE 3 (Data Field)

SHEET 1 of 2
TE700

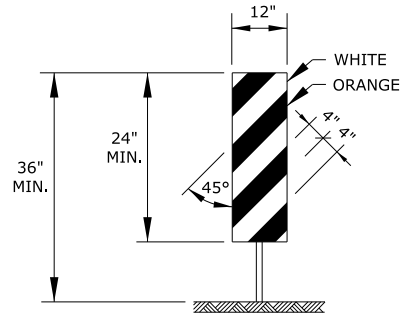
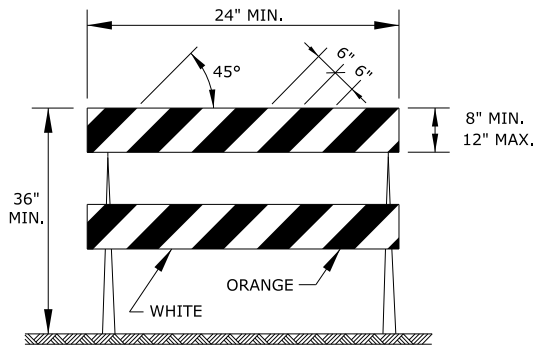
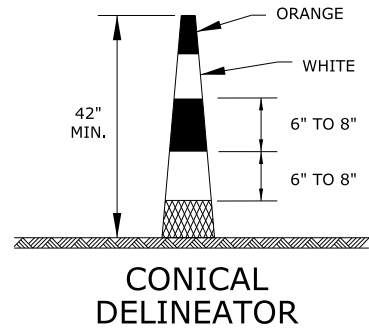
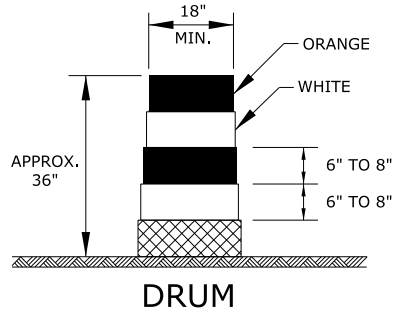

TYPE 2 BARRICADE

For rails less than 36" long, 4" wide stripes may be used. All stripes shall slope downward to the traffic side for channelization.

VERTICAL PANEL

The stripes shall slope downward to the traffic side for channelization.

ITEM	LOCATION	Cross-overs	Shoofly Divisions	Tangents	Tapers	Ramps	Head to Head	Object Identifier	Lead-in Devices	Gores
PORTABLE	Drums	Yes	Yes	Yes	Yes	Yes	(1)	Yes	Yes	Yes
	Conical Delineators	Yes	Yes	Yes	Yes	Yes	(1)	Yes	Yes	Yes
	Vertical Panels	(2)	(2)	(2)	(2)	(2)	(1,2)	YES	(2)	(2)
	Direction Indicator Barricade	NO	NO	NO	Yes	NO	NO	NO	NO	NO
	Type 2 Barricade	(2)	(2)	(2)	(2)	NO	NO	Yes	NO	NO
	Traffic Cones	NO	NO	(4)	(4)	(4)	NO	(4)	(4)	(4)
FIXED										
	Tubular Markers	(3)	(3)	(3)	NO	(3)	Yes	NO	Yes	Yes
	Vertical Panels	(3)	(3)	(3)	(3)	(3)	(3)	Yes	(2,3)	(2)

- (1) Not allowed on centerline delineation along freeways or expressways.
- (2) The stripes shall slope downward to the traffic side for channelization.
- (3) May be used upon the approval of the engineer.
- (4) Daytime operations only.

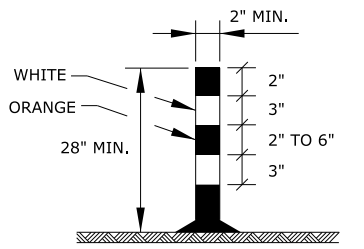

TUBULAR MARKER
Striping as shown for up to 42".

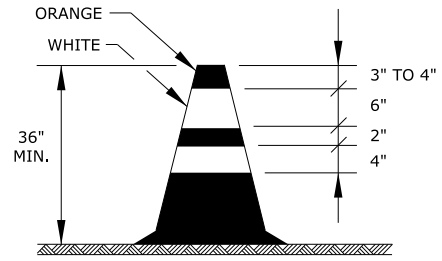

TRAFFIC CONE

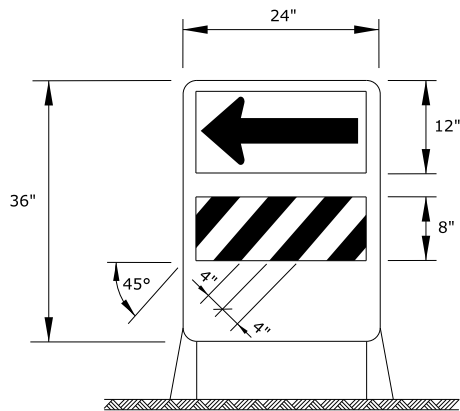

DIRECTION INDICATOR BARRICADE
stripes shall slope downward in the direction traffic is to pass.
direction indicator barricade shall be used in series to direct motorist into the intended lane of travel.

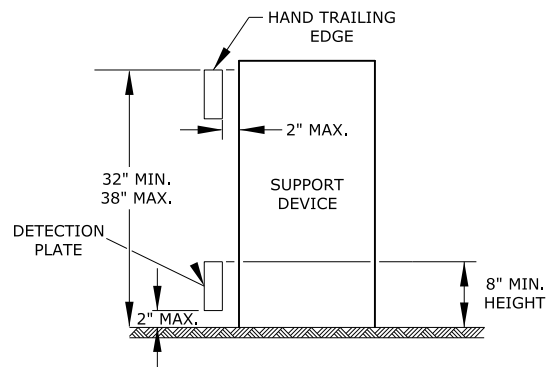

PEDESTRIAN CHANNELIZER

1. Support device shall not project beyond the detection plate into the pathway.
2. Hand trailing edges and detection plates are optional for continuous walls.
3. Interconnect pedestrian channelizers to prevent displacement and to provide continuous guidance through or around work.
4. Alternate pathways shall be firm, stable, and slip resistant.
5. Treat height differentials > 1/2" in the surfaces of alternate paths with a firm, stable, and slip resistant temporary ramp having a slope of 12:1 or flatter and having a width equal to the alternate path.
6. Use alternating orange/white on interconnected devices.

3					KANSAS DEPARTMENT OF TRANSPORTATION
2					FHWA APPROVAL 06/01/15
1					APP'D Kristina Ericksen
NO.	DATE	REVISIONS	BY	APP'D	DESIGNED Robert Bartron

Note: Signs shown for one approach to work zone.

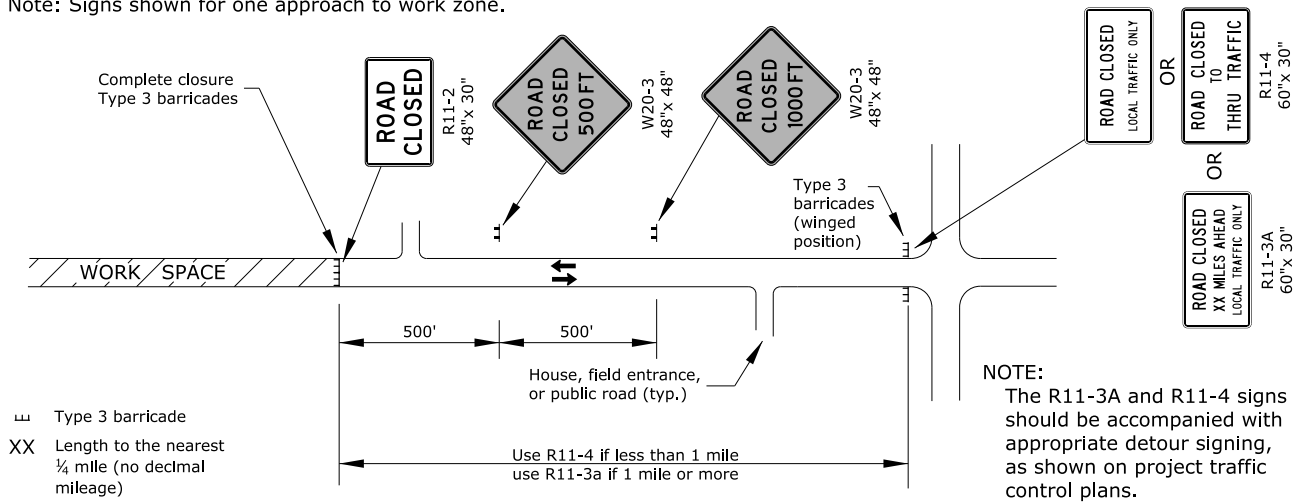

FIGURE 1: TYPICAL SIGNING FOR ROAD CLOSURE (MAINLINE OR SIDE ROAD)

Note: Sign shown for one approach to intersection (work zone).

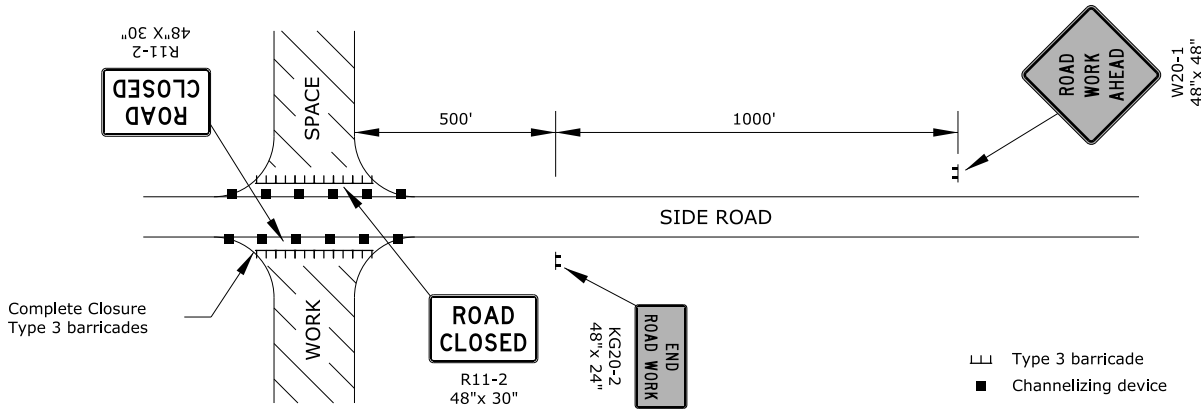

FIGURE 2: TYPICAL SIGNING FOR SIDE ROAD OPEN

Note: Signs shown for one approach to work zone.

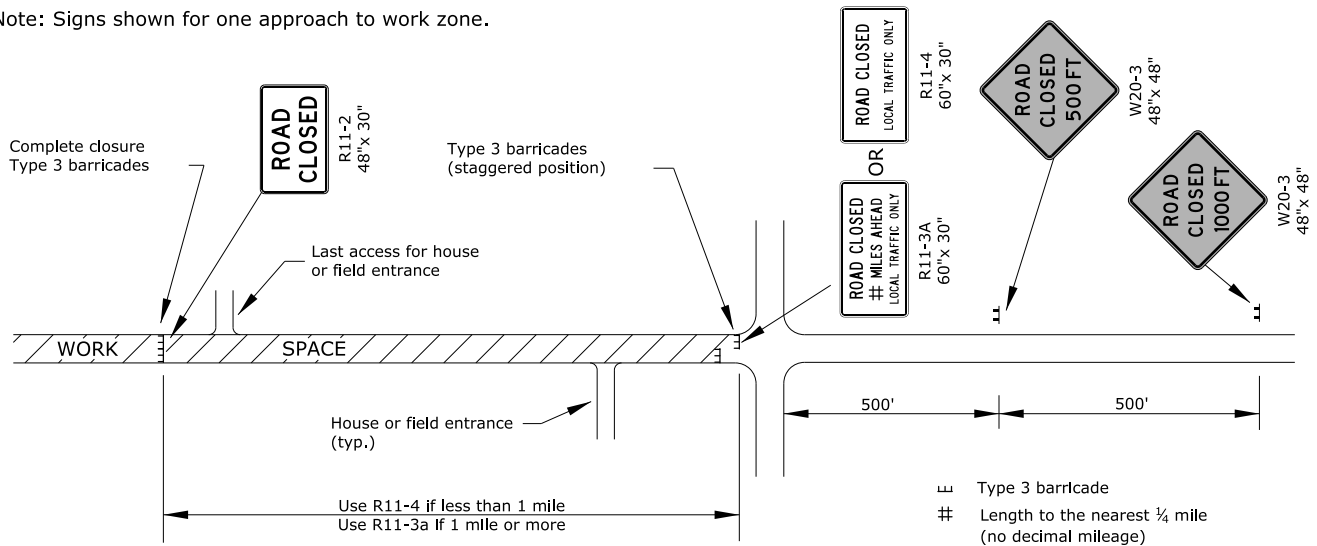

FIGURE 3: TYPICAL SIGNING FOR ROAD CLOSURE - LOCAL TRAFFIC ACCESS

3					KANSAS DEPARTMENT OF TRANSPORTATION
2					FHWA APPROVAL 06/01/15
1					APP'D Kristina Ericksen
NO.	DATE	REVISIONS	BY	APP'D	DESIGNED Robert Bartron

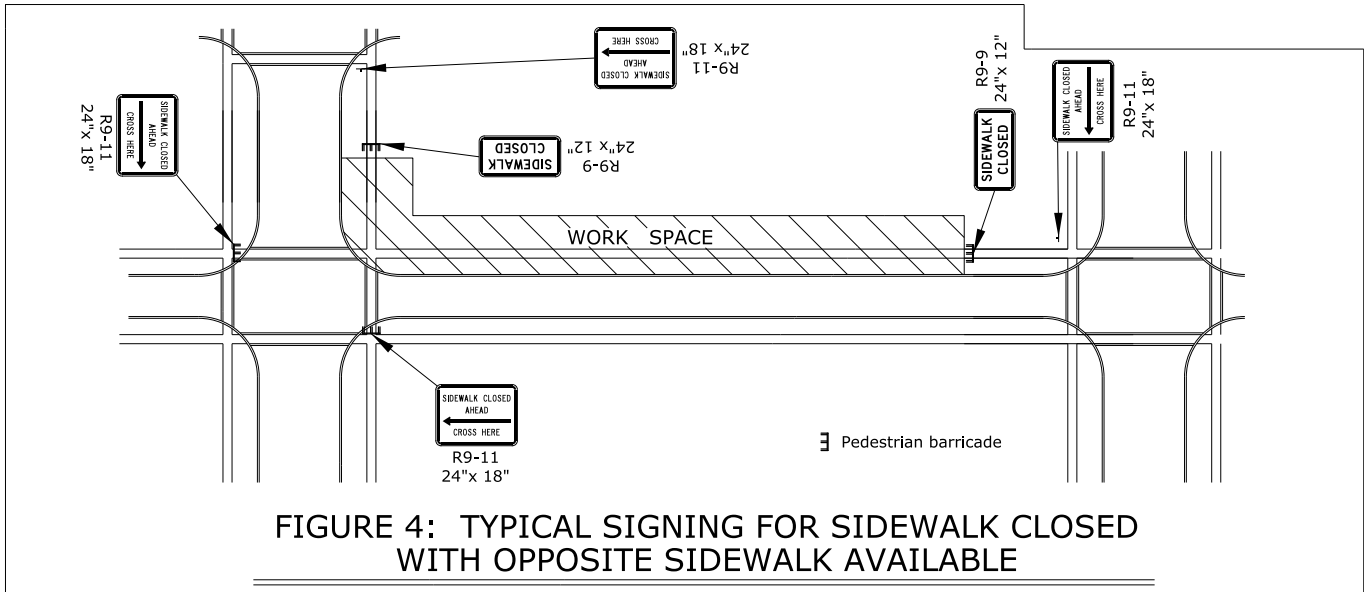
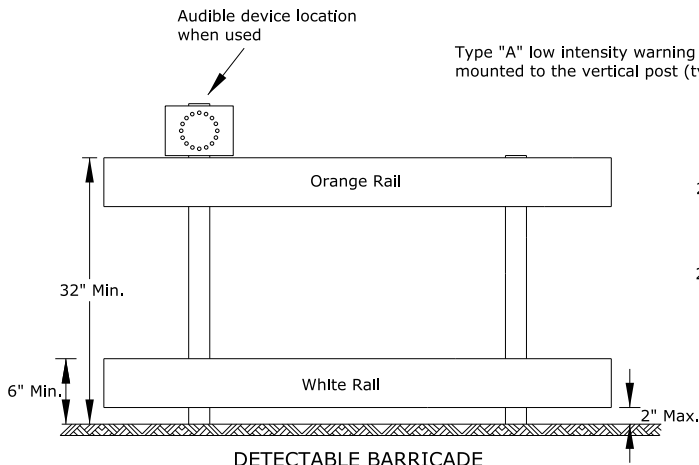
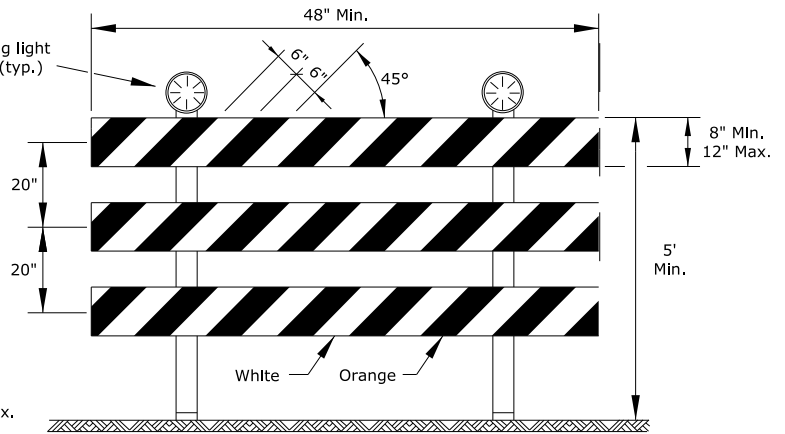

FIGURE 4: TYPICAL SIGNING FOR SIDEWALK CLOSED WITH OPPOSITE SIDEWALK AVAILABLE



1. Support device shall not project beyond the detection plate into the pathway.
2. Barricades shall be used to close the entire width of the pathway.
3. Do not use warning lights on pedestrian barricades.
4. Do not use warning lights on audible devices.



TYPE 3 BARRICADE WITH LIGHTS
 Approved signs mounted on Type 3 barricades should not cover more than 50% of the top two rails or 33% of the total area of the three rails.

When barricades are placed end-to-end or staggered, a Type "A" low intensity warning light shall be mounted to the vertical post near each outside corner of the end barricades.

ROAD CLOSED GENERAL NOTES

As shown in Figure 1, at the point where thru traffic must detour and local traffic can proceed to the location where the roadway is completely closed, the R11-3a (ROAD CLOSED # MILES AHEAD LOCAL TRAFFIC ONLY) or R11-4 (ROAD CLOSED LOCAL TRAFFIC ONLY or ROAD CLOSED TO THRU TRAFFIC) sign shall be used with Type 3 barricades (winged position), placed on the shoulders of roadway.

As shown in Figure 3, when local traffic must be allowed access into the work zone, Type 3 barricades shall be longitudinally staggered to maintain the appearance of a closed roadway. A second line of end-to-end Type 3 barricades shall be placed just beyond the last access point in the work zone, to completely close the roadway.

The R11-4 (ROAD CLOSED TO THRU TRAFFIC or ROAD CLOSED LOCAL TRAFFIC ONLY) sign shall be used when the distance to the point of complete closure of the roadway is less than 1 mile.

The R11-3a (ROAD CLOSED # MILES AHEAD LOCAL TRAFFIC ONLY) sign shall be used when the distance to the point of complete closure of the roadway is 1 mile or greater.

The words "BRIDGE OUT" (or BRIDGE CLOSED) may be substituted for the words "ROAD CLOSED" on the R11-3a or R11-4 sign where applicable.

3					KANSAS DEPARTMENT OF TRANSPORTATION
2					FHWA APPROVAL 06/01/15
1					APP'D Kristina Ericksen
NO.	DATE	REVISIONS	BY	APP'D	DESIGNED Robert Bartron

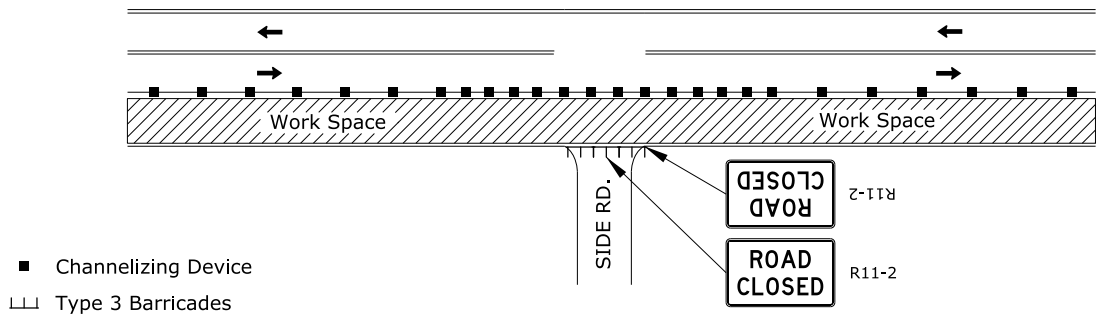

FIGURE 1: SIDE ROAD OR ENTRANCE CLOSED THROUGH WORK AREA

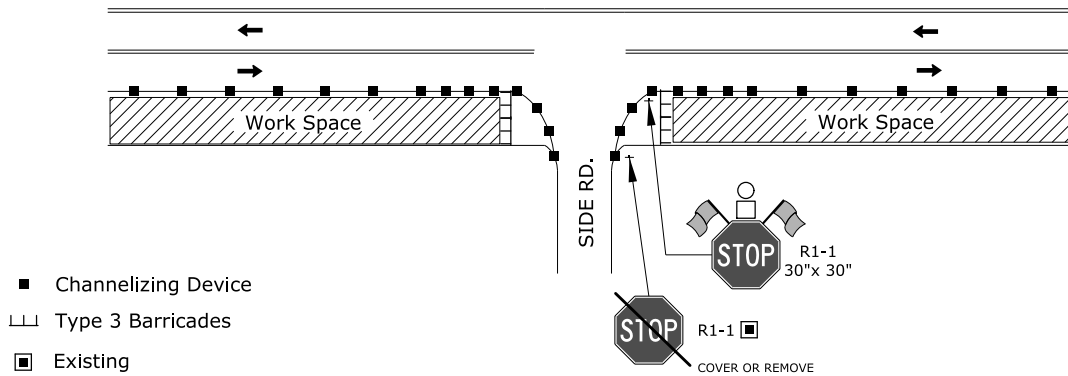

FIGURE 2: SIDE ROAD OR ENTRANCE OPEN THROUGH WORK AREA

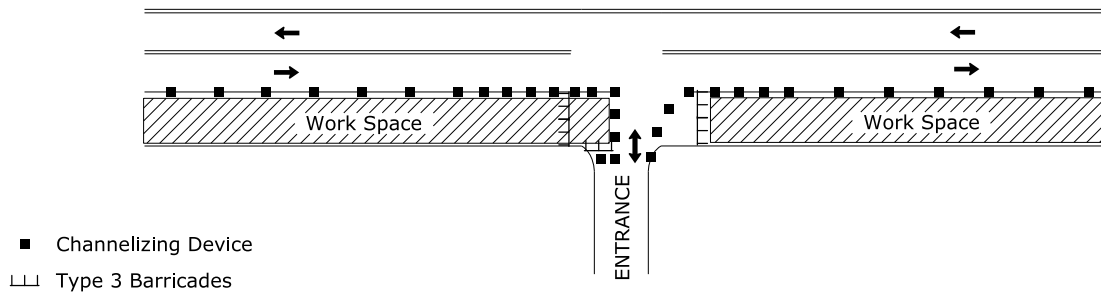
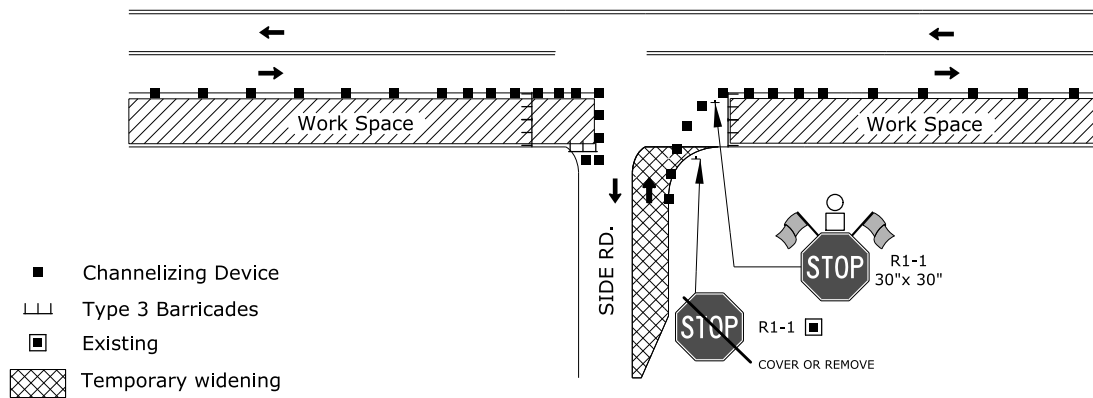

FIGURE 3: LOW VOLUME ENTRANCE CONSTRUCTED HALF AT A TIME

Note: Consider large vehicles making right turns into and out of entrance and use figure 4 as needed

3					KANSAS DEPARTMENT OF TRANSPORTATION
2					FHWA APPROVAL 06/01/15
1					APP'D Kristina Ericksen
NO.	DATE	REVISIONS	BY	APP'D	DESIGNED Robert Bartron



**FIGURE 4: SIDE ROAD OR ENTRANCE CONSTRUCTED HALF AT A TIME:
TWO WAY TRAFFIC REQUIRED**

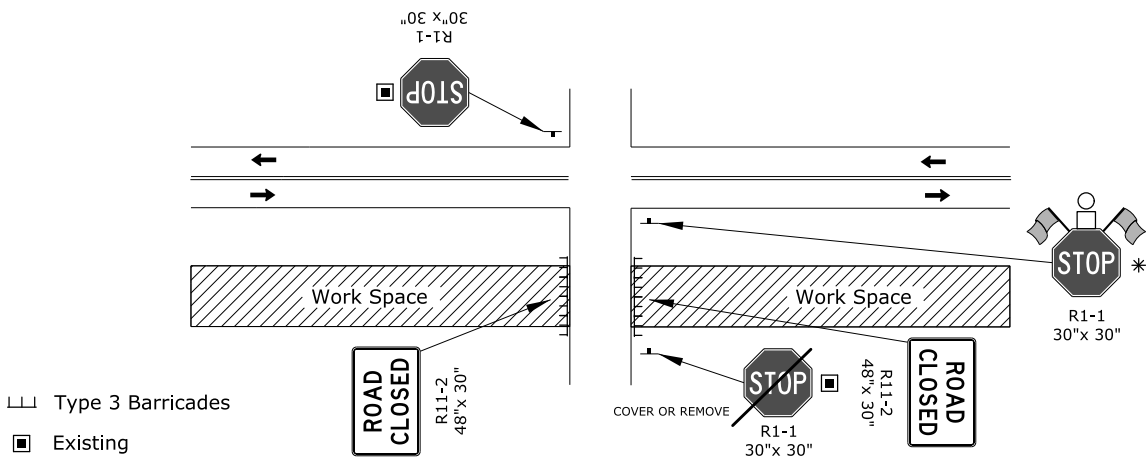









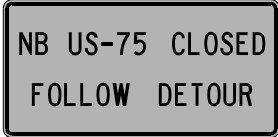
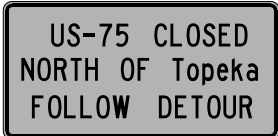

FIGURE 5: SIDE ROAD OPEN THROUGH WORK AREA ON DIVIDED ROADWAY

3					KANSAS DEPARTMENT OF TRANSPORTATION
2					FHWA APPROVAL 06/01/15
1					APP'D Kristina Ericksen
NO.	DATE	REVISIONS	BY	APP'D	DESIGNED Robert Bartron

SIGN LAYOUT INFORMATION

 KG20-2	<u>STD. SIZE</u> <u>EXPWY/FREEWAY</u> 6" C 48"x 24"	 W8-15	<u>STD. SIZE</u> <u>EXPWY/FREEWAY</u> 8" D 48"x 48"						
 KG20-5	<u>STD. SIZE</u> <u>EXPWY/FREEWAY</u> 6" C 48"x 24"	 W8-7	<u>STD. SIZE</u> <u>EXPWY/FREEWAY</u> 8" D 48"x 48"						
 KM4-20	<table border="0" style="margin: auto;"> <tr> <td><u>STD. SIZE</u></td> <td><u>EXPWY/FREEWAY</u></td> </tr> <tr> <td>3" C</td> <td>6" C</td> </tr> <tr> <td>24"x 6"</td> <td>48"x 12"</td> </tr> </table>	<u>STD. SIZE</u>	<u>EXPWY/FREEWAY</u>	3" C	6" C	24"x 6"	48"x 12"	 W8-15p	<u>STD. SIZE</u> <u>EXPWY/FREEWAY</u> 30"x 24"
<u>STD. SIZE</u>	<u>EXPWY/FREEWAY</u>								
3" C	6" C								
24"x 6"	48"x 12"								
 W7-3a	Mileage to be determined by the engineer.								
 W8-17	<u>STD. SIZE</u> <u>EXPWY/FREEWAY</u> 48"x 48"	 W8-11	<u>STD. SIZE</u> <u>EXPWY/FREEWAY</u> 8" D 48"x 48"						
 W8-17P (OPTIONAL)	<u>STD. SIZE</u> <u>EXPWY/FREEWAY</u> 30"x 24"								
 SP-01 (SPECIAL SIGN)	<table border="0" style="margin: auto;"> <tr> <td><u>STD. SIZE</u></td> <td><u>EXPWY/FREEWAY</u></td> </tr> <tr> <td>6" C</td> <td>10" D</td> </tr> </table>	<u>STD. SIZE</u>	<u>EXPWY/FREEWAY</u>	6" C	10" D				
<u>STD. SIZE</u>	<u>EXPWY/FREEWAY</u>								
6" C	10" D								
 SP-02 (SPECIAL SIGN)	<table border="0" style="margin: auto;"> <tr> <td><u>STD. SIZE</u></td> <td><u>EXPWY/FREEWAY</u></td> </tr> <tr> <td>UPPERCASE: 6" C</td> <td>UPPERCASE: 10" D</td> </tr> <tr> <td>LOWERCASE: 4.5" C</td> <td>LOWERCASE: 8" D</td> </tr> </table>	<u>STD. SIZE</u>	<u>EXPWY/FREEWAY</u>	UPPERCASE: 6" C	UPPERCASE: 10" D	LOWERCASE: 4.5" C	LOWERCASE: 8" D		
<u>STD. SIZE</u>	<u>EXPWY/FREEWAY</u>								
UPPERCASE: 6" C	UPPERCASE: 10" D								
LOWERCASE: 4.5" C	LOWERCASE: 8" D								

ALL CITY NAMES AND STREET NAMES ON SPECIAL SIGNS AND DESTINATION SIGNS
MUST HAVE UPPER AND LOWER CASE LETTERS.

3						KANSAS DEPARTMENT OF TRANSPORTATION
2						FHWA APPROVAL 06/01/15
1						APP'D Kristina Ericksen
NO.	DATE	REVISIONS	BY	APP'D	DESIGNED	Robert Bartron

TRAFFIC CONTROL
SIGN INFORMATION
TITLE LINE 3 (Data Field)

SHEET 1 of 3
TE710

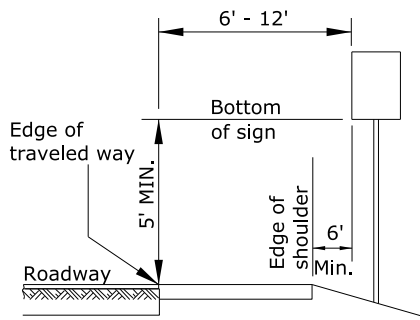

Rural

- 1) Ground-mounted signs shall be mounted at a minimum height of 5' measured from the bottom of sign to the near edge of the pavement.
- 2) Large signs having an area exceeding 50 square feet installed on multiple breakaway posts shall be mounted a minimum of 7' above the ground.
- 3) The height of the secondary sign mounted below another sign may be 4' measured from the bottom of the sign to the near edge of the pavement. Signs shall not overlap each other.

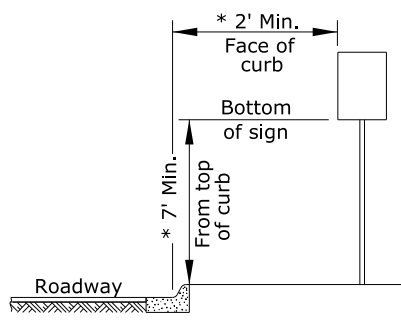

Urban

- 1) Signs shall be mounted at a minimum height of 7' measured from the bottom of sign to the near edge of the pavement.
- 2) Neither portable nor permanent sign supports should be located on sidewalks or areas designated for pedestrian or bicycle traffic.
- 3) Signs mounted lower than 7' should not project more than 4" into pedestrian facilities.
- 4) The height from of the secondary sign mounted below another sign may be 6' measured from the bottom of sign to the near edge of the pavement. Signs shall not overlap each other.
- 5) Large signs having an area exceeding 50 square feet installed on multiple breakaway posts shall be mounted a minimum of 7' above the ground.
- * 6) Pedestrian detour signing shall be a minimum of 2' measured from the top of the pedestrian pathway to the bottom of the sign and shall not protrude into the walkway nor shall it project beyond the back of curb.

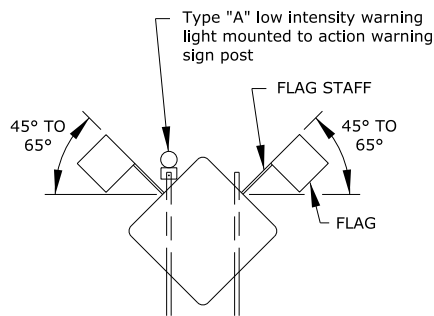

When the sign width is equal to or greater than 9', three or more wood posts may be used with a minimum of 4' between the centerline of each post. All signs less than 9' in width shall use a maximum of two wood posts.

In the case of hitting rock when driving posts

1. Shift the sign location. Do not violate minimum sign spacing.
2. With the engineer's approval, use acceptable alternative sign stands.

3					KANSAS DEPARTMENT OF TRANSPORTATION
2					FHWA APPROVAL 06/01/15
1					APP'D Kristina Ericksen
NO.	DATE	REVISIONS	BY	APP'D	DESIGNED Robert Barrton

TRAFFIC CONTROL
SIGN INFORMATION
TITLE LINE 3 (Data Field)

SHEET 2 of 3
TE710

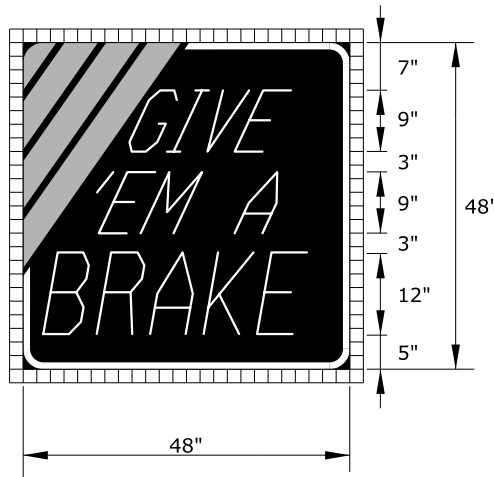

KI-104a

SIGN NUMBER	GIVE EM A BRAKE
WIDTH x HEIGHT	4'-0" x 4'-0"
BORDER WIDTH	1.0"
CORNER RADIUS	4.0"
STRIPE WIDTH	3.0"
MOUNTING	GROUND
BACKGROUND	TYPE: NON-REFLECTIVE
	COLOR: BLACK
LEGEND/BORDER	TYPE: REFLECTIVE
	COLOR: WHITE
LEGEND FONT	DUTCH 801 ROMAN SWC 25 DEGREE SLANT
STRIPES	TYPE: REFLECTIVE
	COLOR: ORANGE

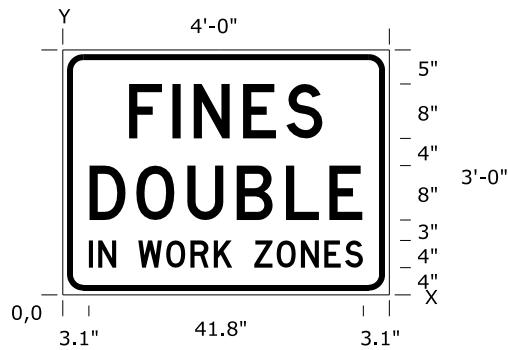

KI-105a

SIGN NUMBER	FINES DOUBLE
WIDTH x HEIGHT	4'-0" x 3'-0"
BORDER WIDTH	0.9"
CORNER RADIUS	3.0"
MOUNTING	GROUND
BACKGROUND	TYPE: REFLECTIVE
	COLOR: WHITE
LEGEND/BORDER	TYPE: NON-REFLECTIVE
	COLOR: BLACK

DIMENSIONS IN INCHES

SPACINGS ARE TO START OF NEXT LETTER

Y FONT	LETTER SPACINGS													HT LEN					
23.0 D	F	I	N	E	S														8.0 28.6
11.0 D	D	O	U	B	L	E													8.0 40.3
4.0 D	I	N	W	O	R	K	Z	O	N	E	S								4.0 41.8

Notes:

Typically, there are two sets of informational signs installed per project: one for each direction of traffic.

Install signs a minimum of 500' in advance of the road work ahead sign. The engineer may designate a more appropriate location if conditions dictate.

The informational signs are not to interfere with the traffic control signs for the project.

3					KANSAS DEPARTMENT OF TRANSPORTATION
2					FHWA APPROVAL 06/01/15
1					APP'D Kristina Ericksen
NO.	DATE	REVISIONS	BY	APP'D	DESIGNED Robert Bartron

TRAFFIC CONTROL
SIGN INFORMATION
TITLE LINE 3 (Data Field)

SHEET 3 of 3
TE710

Perforated square steel tube (P.S.S.T.) post setup

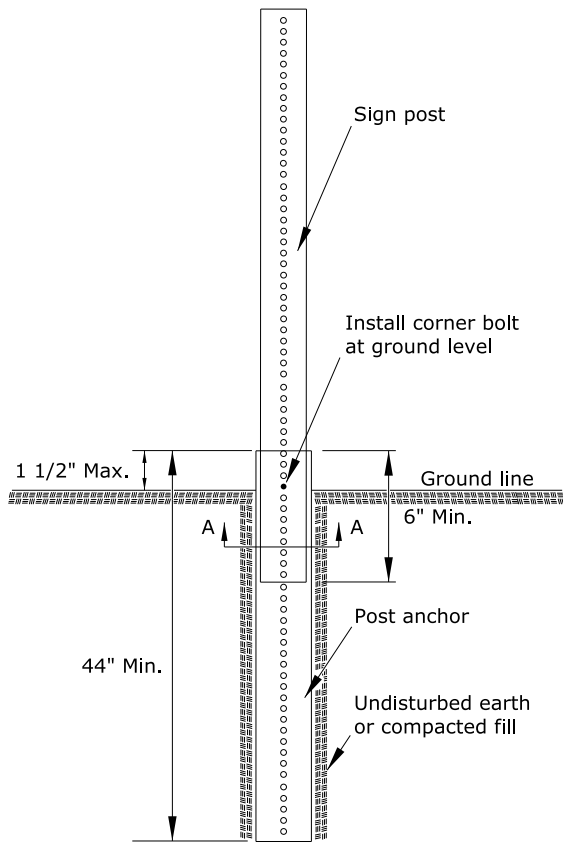

P.S.S.T. detail

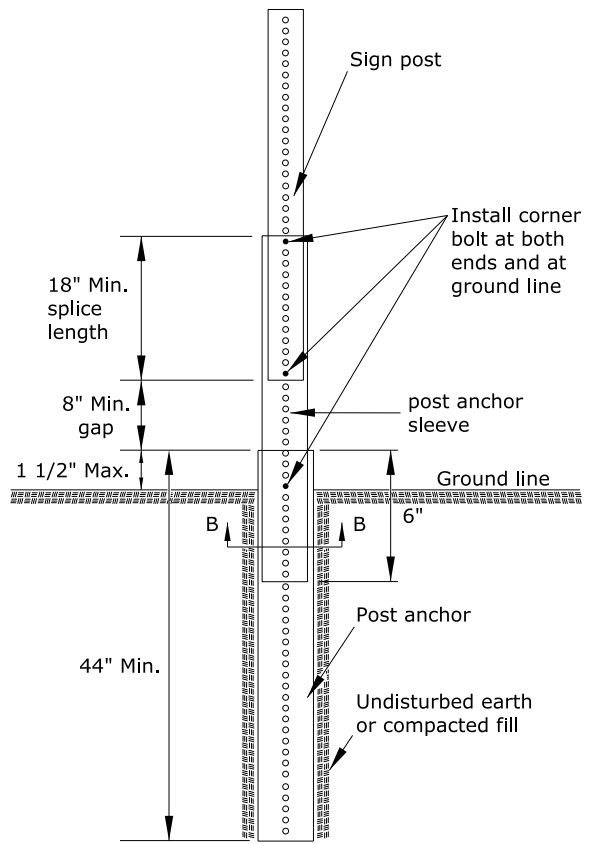

Telescoping P.S.S.T. detail

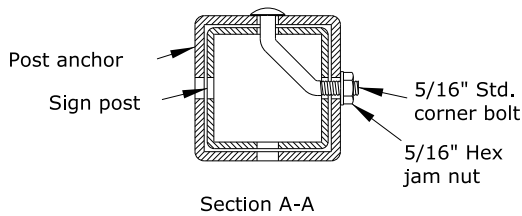

Section A-A

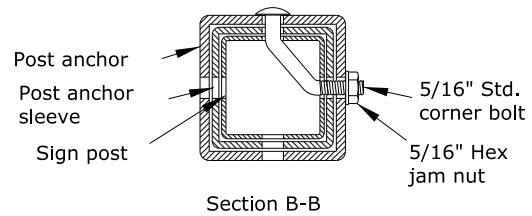

Section B-B

Details for 2", 2 1/4", or 2 1/2" sign posts
Place bolts in the same corner along each sign post.

3					KANSAS DEPARTMENT OF TRANSPORTATION
2					FHWA APPROVAL 06/01/15
1					APP'D Kristina Ericksen
NO.	DATE	REVISIONS	BY	APP'D	DESIGNED Robert Bartron

Wood post setup

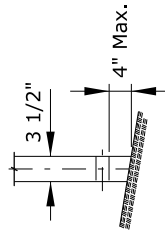
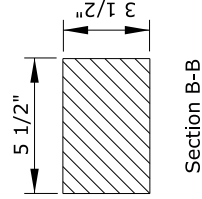
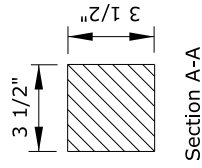
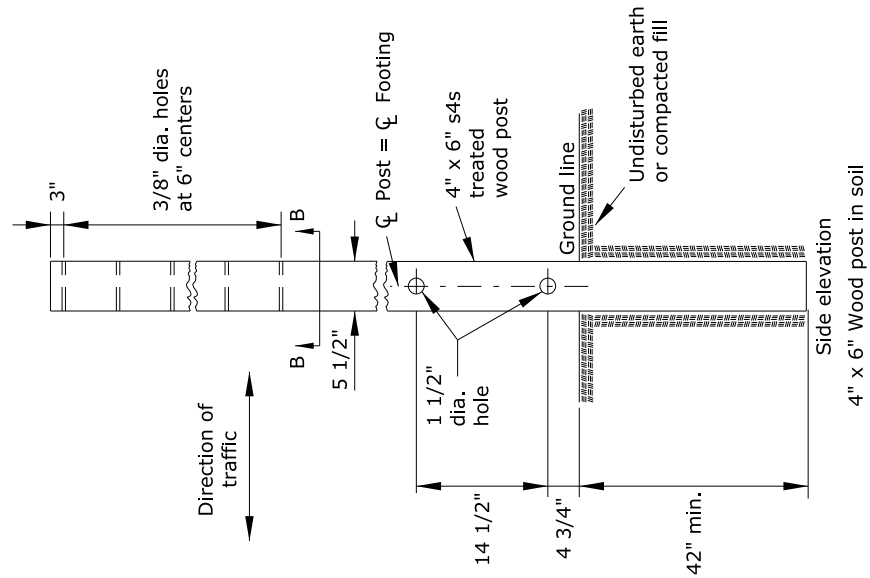
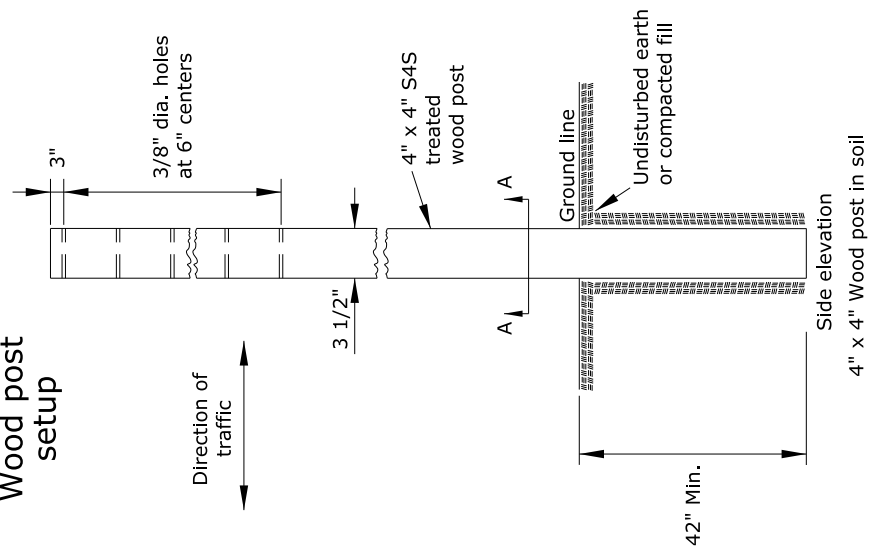

NO.	DATE	REVISIONS	BY	APP'D	DESIGNED
3					KANSAS DEPARTMENT OF TRANSPORTATION
2					FHWA APPROVAL 06/01/15
1					APP'D Kristina Ericksen
					DESIGNED Robert Bartron

TRAFFIC CONTROL
SIGN POSTS
TITLE LINE 3 (Data Field)

3 lb/f U-Channel setup

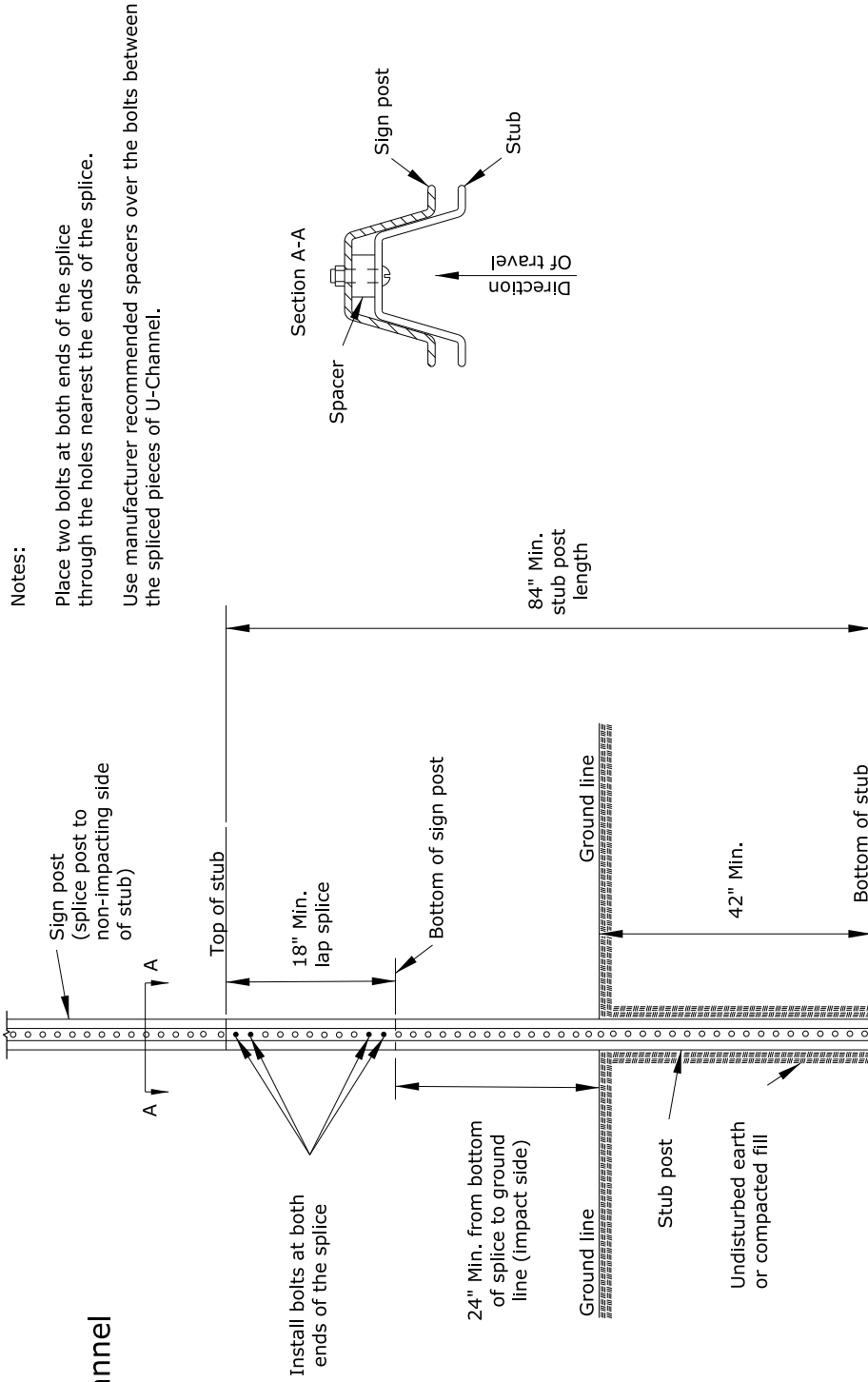

Notes:
 Place two bolts at both ends of the splice through the holes nearest the ends of the splice.
 Use manufacturer recommended spacers over the bolts between the spliced pieces of U-Channel.

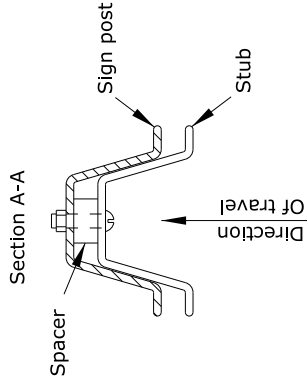

KDOT Graphics Certified 06-01-2015

3					KANSAS DEPARTMENT OF TRANSPORTATION
2					FHWA APPROVAL 06/01/15
1					APP'D Kristina Ericksen
NO.	DATE	REVISIONS	BY	APP'D	DESIGNED Robert Bartron

TRAFFIC CONTROL
 SIGN POSTS
 TITLE LINE 3 (Data Field)

SHEET 3 of 3
 TE712

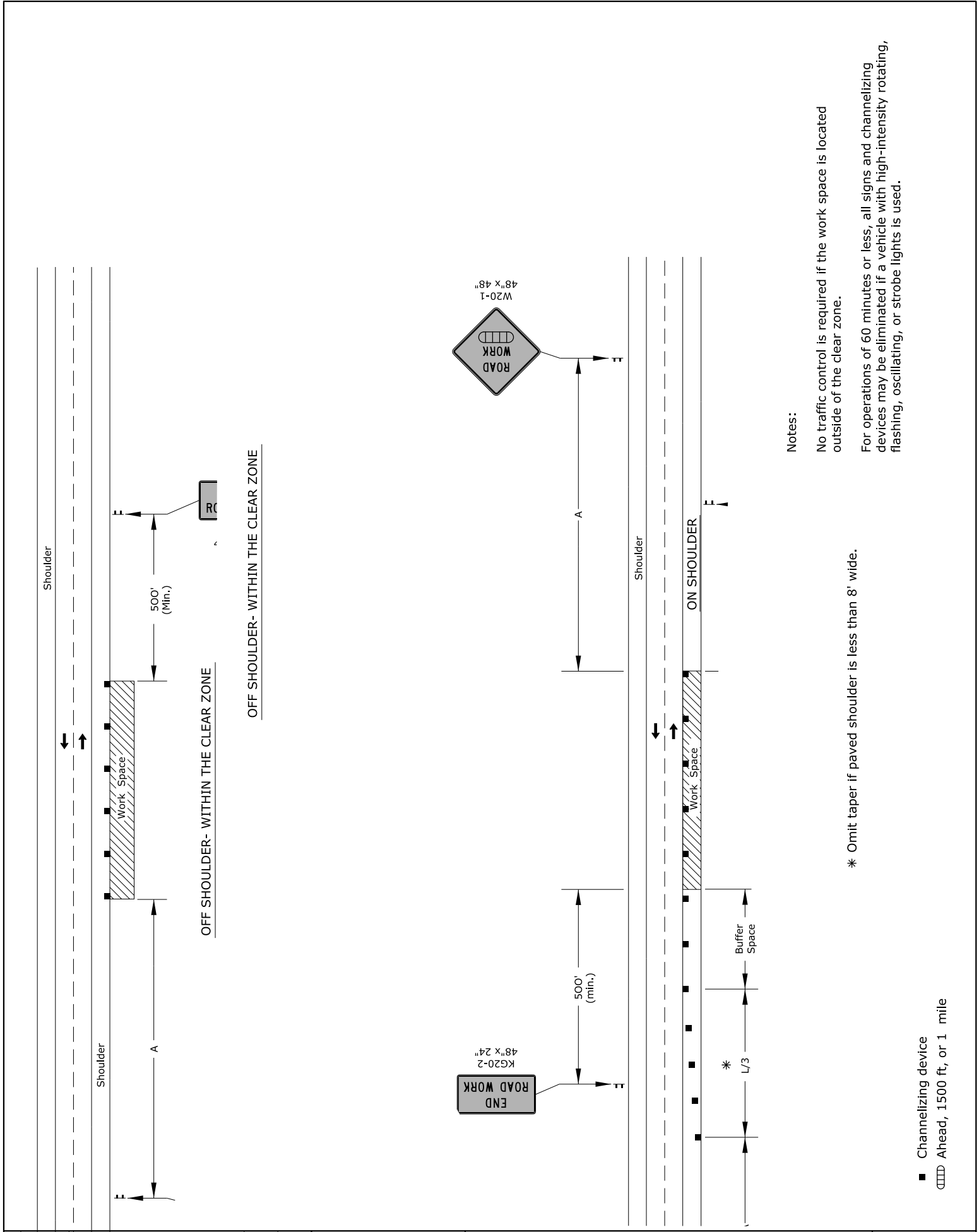

Notes:

No traffic control is required if the work space is located outside of the clear zone.

For operations of 60 minutes or less, all signs and channelizing devices may be eliminated if a vehicle with high-intensity rotating, flashing, oscillating, or strobe lights is used.

* Omit taper if paved shoulder is less than 8' wide.

- Channelizing device
- ▭ Ahead, 1500 ft, or 1 mile

3						KANSAS DEPARTMENT OF TRANSPORTATION
2						FHWA APPROVAL 06/01/15
1						APP'D Kristina Ericksen
NO.	DATE	REVISIONS	BY	APP'D	DESIGNED	Robert Bartron

**TRAFFIC CONTROL
SHOULDER WORK
UNDIVIDED HIGHWAY**

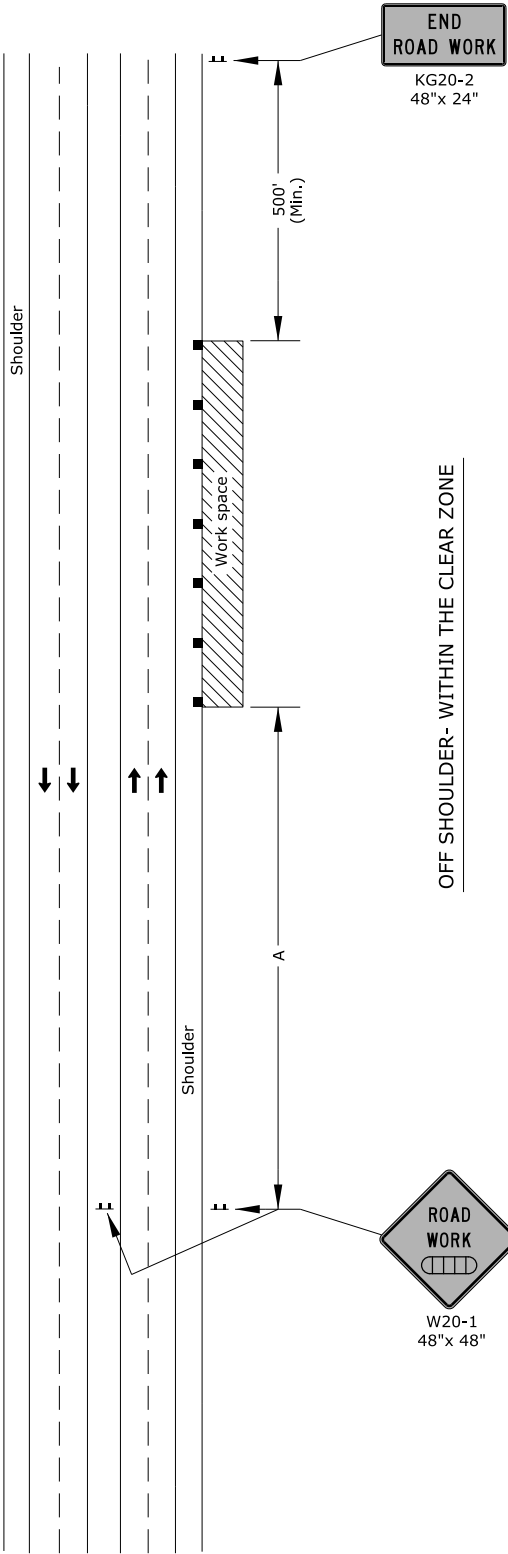

OFF SHOULDER- WITHIN THE CLEAR ZONE

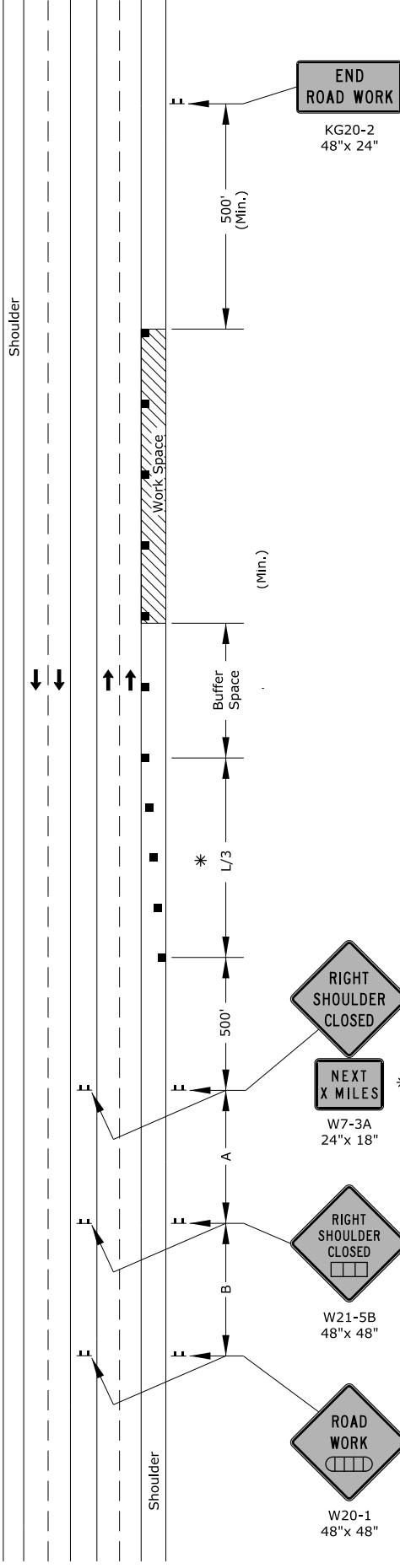

Notes:

For work in the median, install signs and channelizing devices for each direction of traffic according to the applicable typical drawing.

No traffic control is required if the work space is located outside of the clear zone.

For operations of 60 minutes or less, all signs and channelizing devices may be eliminated if a vehicle with a high-intensity rotating, flashing, oscillating, or strobe light is used.

- * Omit taper if paved shoulder is less than 8' wide.
- ** Eliminate W7-3A if shoulder is closed for less than 2 miles.

- X Length to the nearest whole mile
- Channelizing device
- ▨ Ahead, 1500 ft, or 1 mile
- ▩ Ahead, 1000 ft, 1500 ft or 1/2 mile

3					KANSAS DEPARTMENT OF TRANSPORTATION
2					FHWA APPROVAL 06/01/15
1					APP'D Kristina Ericksen
NO.	DATE	REVISIONS	BY	APP'D	DESIGNED Robert Bartron

USE TE731 FOR FLAGGER OR PILOT CAR ON ROADWAYS WITH CONCRETE SHOULDERS GREATER THAN 8 FT.

FLAGGER

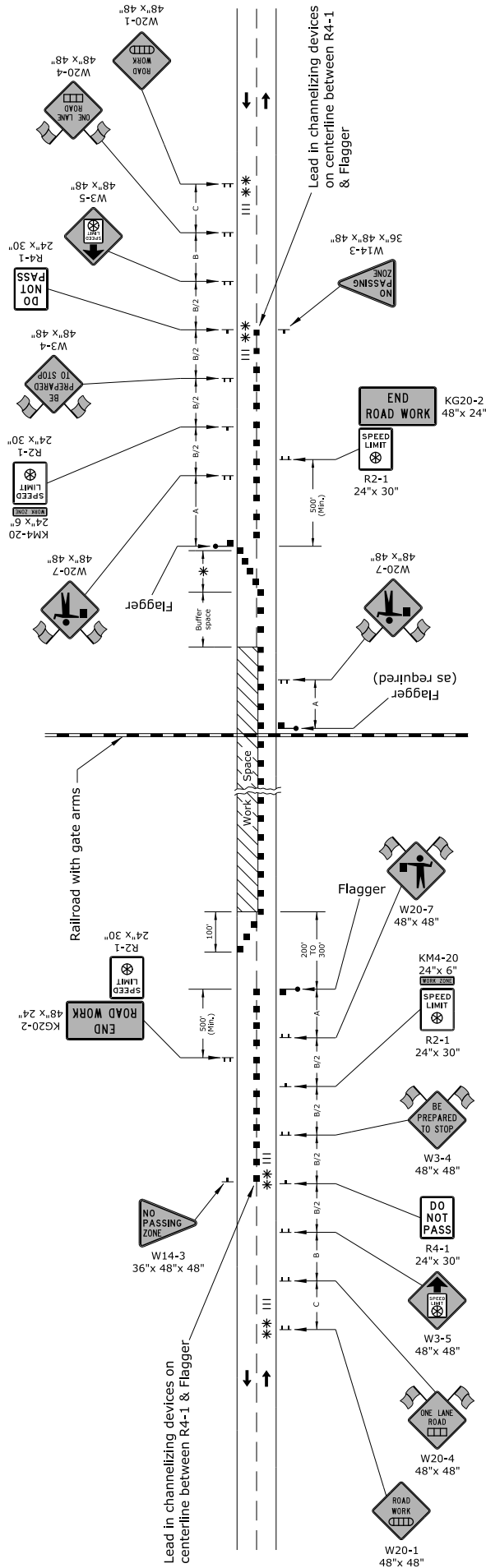

Notes:

Trucks hauling material to the project should STOP at the Flagger. After stopping, upon approval of the Engineer, trucks may be allowed to move around the Flagger.

Place a Flagger at all highway and major collector intersections and at-grade railroad intersections with lights and gates in the work space to control traffic crossing the tracks to the left of the gate arm. The need for a Flagger at minor side road intersections shall be determined by the Engineer. Place a W20-7 (Flagger symbol) sign on each side road that is controlled by a Flagger.

Existing signs shall not be covered or removed between Flagger stations. Temporary rumble strips may be used in lieu of lead in channelizing devices when the roadway is less than or equal to 30' including paved shoulders. When extenuating circumstances exist, the Area Engineer may elect to eliminate both the lead in channelizers and the rumble strips.

- Channelizing device
- ▨ Ahead, 1500 ft, or 1 mile
- ▨ Ahead, 1000 ft, 1500 ft, or 1/2 mile
- ⊗ Speed to be determined by the Engineer
- Type "A" low intensity warning light
- ||| Temporary portable rumble strips

** Minimum six (6) channelizers spaced at 20' intervals.

** Optional rumble strips may be placed: One set between the W20-1 and W20-4, and one set between the R4-1 and W3-4, on each approach.

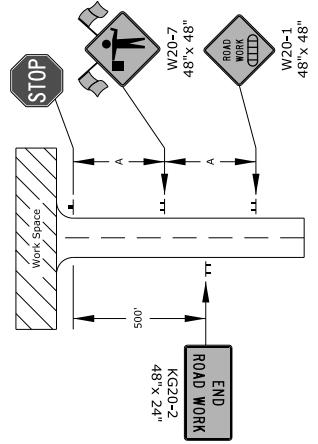

NO.	DATE	REVISIONS	BY	APP'D	DESIGNED
3					
2					
1					

KANSAS DEPARTMENT OF TRANSPORTATION					
FHWA APPROVAL 06/01/15					
APP'D Kristina Ericksen					
DESIGNED Robert Bartron					

TRAFFIC CONTROL
FLAGGER OR PILOT CAR
TITLE LINE 3 (Data Field)

USE TE731 FOR FLAGGER OR PILOT CAR ON ROADWAYS WITH CONCRETE SHOULDERS GREATER THAN 8 FT.

FLAGGER AND PILOT CAR

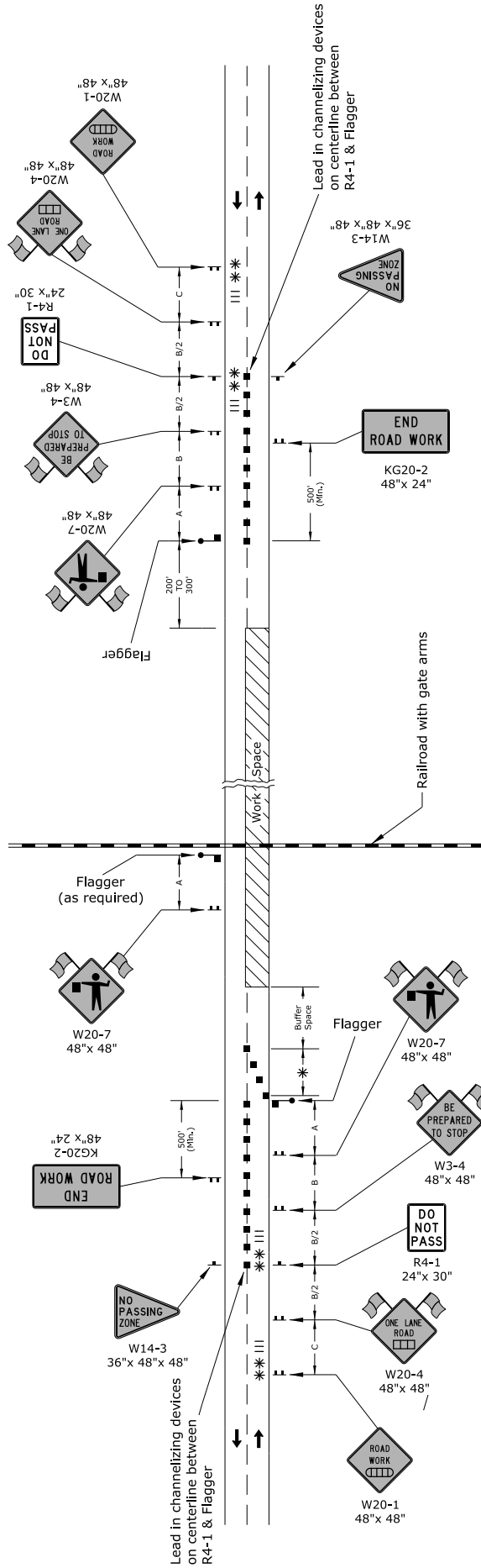

△ Not required on substantial maintenance projects (1R).

△△ The KG20-5 (WAIT FOR PILOT CAR) sign shall be mounted on an approved portable support and not attached to the existing stop sign post.

The KG20-5 sign shall be placed immediately in front of the existing stop sign, a minimum of 6" below the bottom of the stop sign. The sign should be removed or covered when there is no pilot car.

Typical signing for a minor side road approach to work space

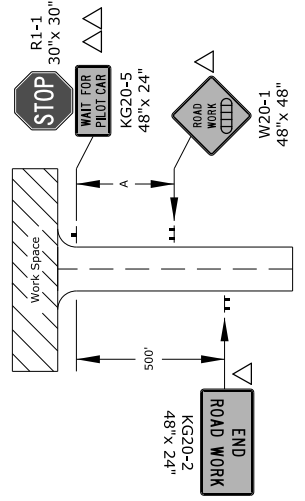

* Minimum six (6) channelizers spaced at 20' intervals.

** Optional rumble strips may be placed: One set between the W20-1 and W20-4, and one set between the R4-1 and W3-4, on each approach.

Notes:

Trucks hauling material to the project should STOP at the Flagger. After stopping, upon approval of the Engineer, trucks may be allowed to move around the Flagger.

Place a Flagger at all highway and major collector intersections and at-grade railroad intersections with lights and gates in the work space to control traffic crossing the tracks to the left of the gate arm. The need for a Flagger at minor side road intersections shall be determined by the Engineer. Place a W20-7 (Flagger symbol) sign on each side road that is controlled by a Flagger.

Existing signs shall not be covered or removed between Flagger stations.

Temporary rumble strips may be used in lieu of lead in channelizing devices when the roadway is less than or equal to 30' including paved shoulders. When extenuating circumstances exist, the Area Engineer may elect to eliminate both the lead in channelizers and the rumble strips.

Typical signing for highway or major collector approach to work space

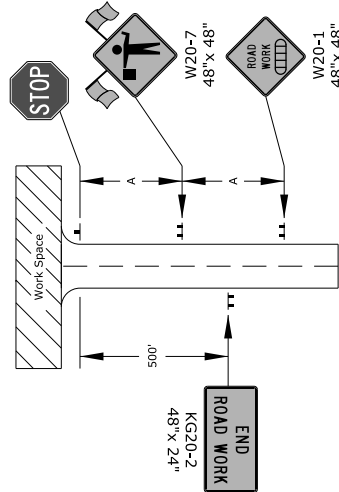

■ Channelizing device

- ▬ Ahead, 1500 ft, or 1 mile
- ▬ Ahead, 1000 ft, 1500 ft, or 1/2 mile
- ⊗ Speed to be determined by the Engineer
- Type "A" low intensity warning light
- ||| Temporary portable rumble strips

3					KANSAS DEPARTMENT OF TRANSPORTATION
2					FHWA APPROVAL 06/01/15
1					APP'D Kristina Ericksen
NO.	DATE	REVISIONS	BY	APP'D	DESIGNED Robert Bartron

FLAGGER

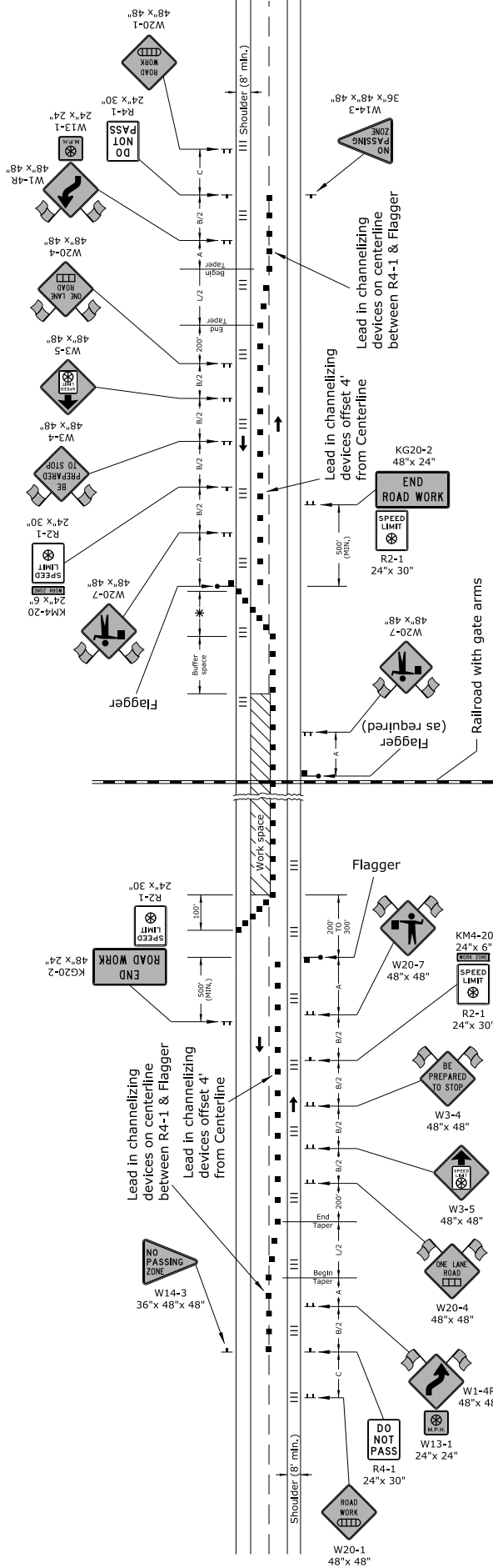

Notes:

Trucks hauling material to the project should STOP at the Flagger. After stopping, upon approval of the Engineer, trucks may be allowed to move around the Flagger. Place a Flagger at all highway, major collector intersections and at-grade railroad intersections with lights and gates in the work space to control traffic crossing the tracks to the left of the gate arm. The need for a Flagger at minor side road intersections shall be determined by the Engineer. Place a W20-7 (Flagger symbol) sign on each side road that is controlled by a Flagger.

Existing signs shall not be covered or removed between Flagger stations. Temporary rumble strips may be used in lieu of lead in channelizing devices when the roadway is less than or equal to 30' including paved shoulders. When extenuating circumstances exist, the Area Engineer may elect to eliminate both the lead in channelizers and the rumble strips.

* Minimum six (6) channelizers spaced at 20' intervals.

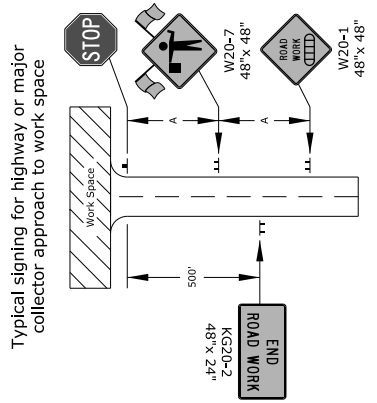

- Channelizing Device
- Ahead, 1500 Ft, Or 1 Mile
- Ahead, 1000 Ft, 1500 Ft, Or 1/2 Mile
- ⊗ Speed to be determined by the Engineer
- ||| Existing shoulder rumble strips

3					KANSAS DEPARTMENT OF TRANSPORTATION
2					FWHA APPROVAL 06/01/15
1					APP'D Kristina Erickson
NO.	DATE	REVISIONS	BY	APP'D	DESIGNED Robert Bartron

FLAGGER AND PILOT CAR

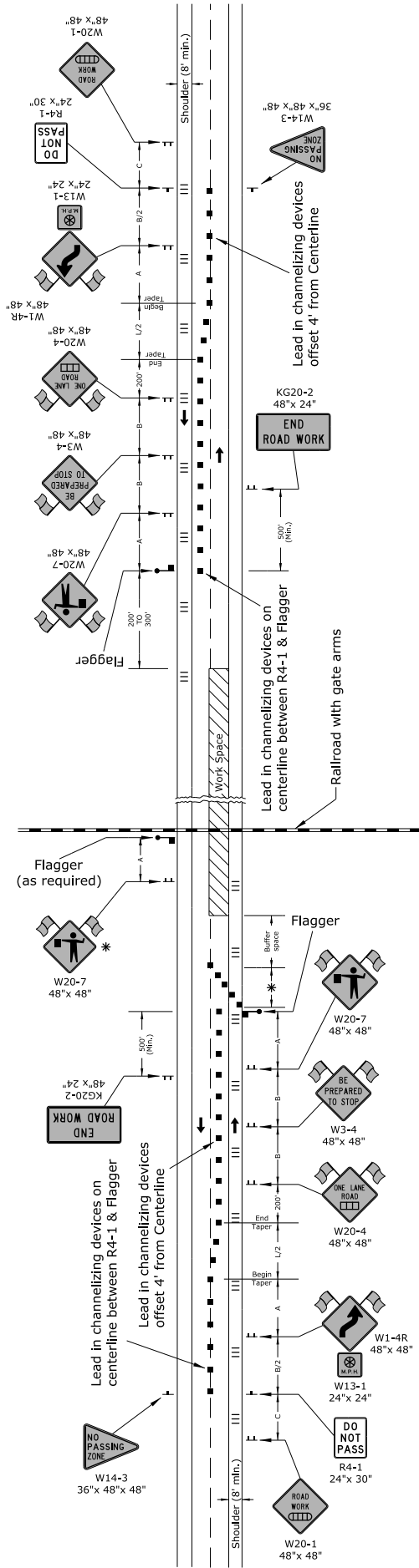

* Minimum six (6) channelizers spaced at 20' intervals.

△ Not required on substantial maintenance projects (1R).

△△ The KG20-5 (WAIT FOR PILOT CAR) sign shall be mounted on an approved portable support and not attached to the existing stop sign post.

The KG20-5 sign shall be placed immediately in front of the existing stop sign, a minimum of 6" below the bottom of the stop sign. The sign should be removed or covered when there is no pilot car.

Notes:
Trucks hauling material to the project should STOP at the Flagger. After stopping, upon approval of the Engineer, trucks may be allowed to move around the Flagger.

Place a Flagger at all highway, major collector intersections and at-grade railroad intersections with lights and gates in the work space to control traffic crossing the tracks to the left of the gate arm. The need for a Flagger at minor side road intersections shall be determined by the Engineer. Place a W20-7 (Flagger symbol) sign on each side road that is controlled by a Flagger.

Existing signs shall not be covered or removed between Flagger stations.
Temporary rumble strips may be used in lieu of lead in channelizing devices when the roadway is less than or equal to 30' including paved shoulders. When extenuating circumstances exist, the Area Engineer may elect to eliminate both the lead in channelizers and the rumble strips.

Typical signing for highway or major collector approach to work space

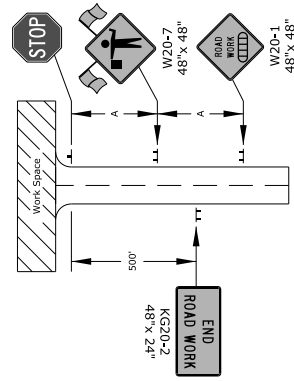

Typical signing for a minor side road approach to work space

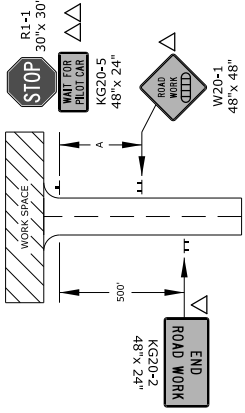

- Channelizing Device
- ▨ Ahead, 1500 Ft, Or 1 Mile
- ▧ Ahead, 1000 Ft, 1500 Ft, Or 1/2 Mile
- ⊗ Speed to be determined by the Engineer
- ||| Existing shoulder rumble strips

3						KANSAS DEPARTMENT OF TRANSPORTATION
2						FHWA APPROVAL 06/01/15
1						APP'D Kristina Ericksen
NO.	DATE	REVISIONS	BY	APP'D	DESIGNED	Robert Bartron

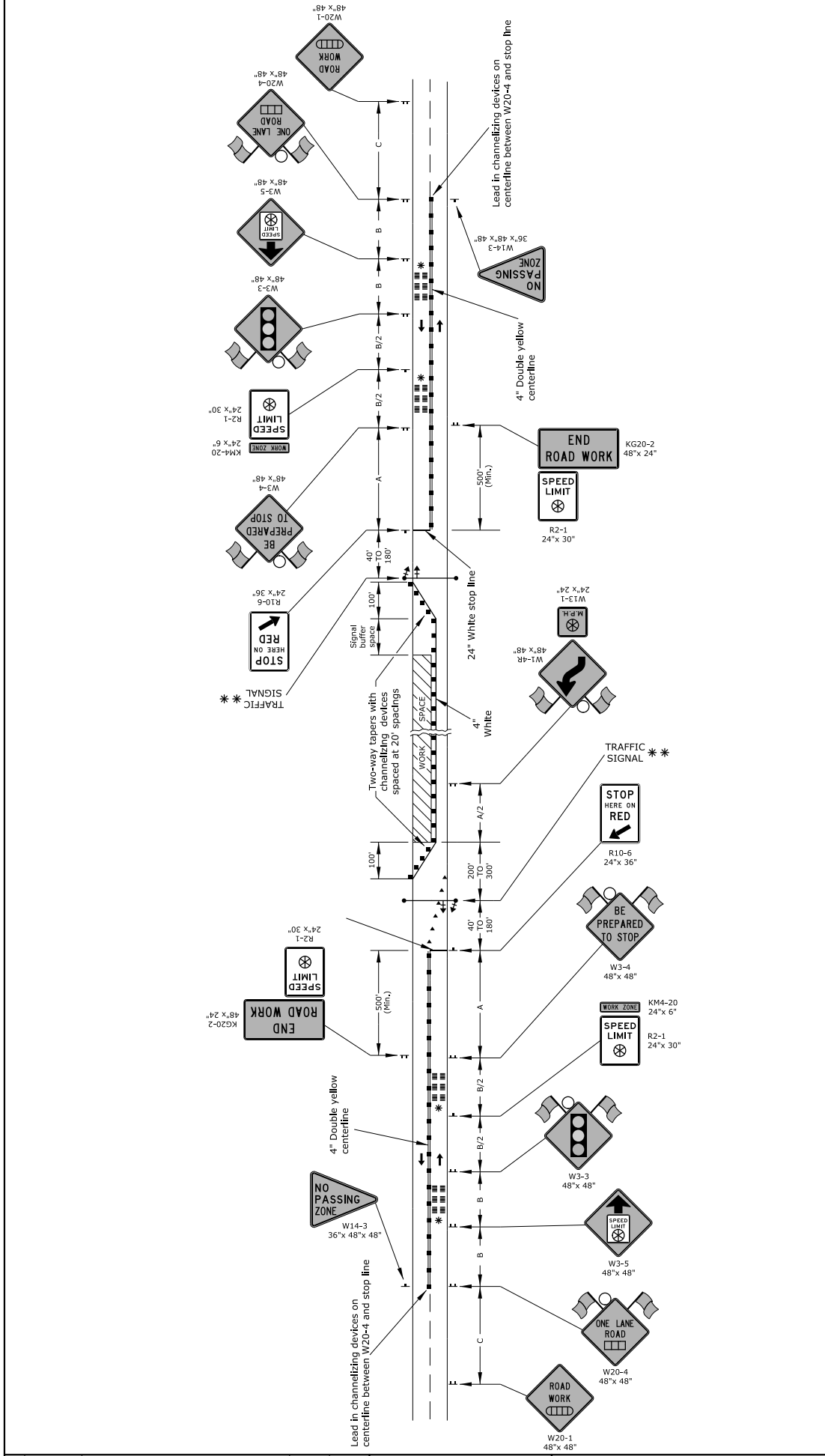

Note: Refer to TE733 and TE734 for additional temporary traffic signal details.

SIGNAL BUFFER SPACE

SPEED (MPH)	20	25	30	35	40	45	50	55	60	65	70
LENGTH (FT)	35	50	65	85	100	115	130	150	165	165	165

Neither work activity nor storage of equipment, vehicles, or material should occur in the buffer space. When a protection vehicle is placed in advance of the work space, only the space upstream of the vehicle constitutes the buffer space.

▲ Posted speed prior to work starting

- ▲ Uni-directional yellow temporary raised pavement marker (Type 1) (facing right)
- Channelizing device
- ▤ Ahead, 1500 ft, or 1 mile
- ▥ Ahead, 1000 ft, 1500 ft, or 1/2 mile
- ⊗ Speed to be determined by the Engineer
- ⊖ Signal head with back plate
- Temporary signal pole or trailer
- Type "A" low intensity warning light

NO.	DATE	REVISIONS	BY	APP'D	DESIGNED
3					
2					
1					

KANSAS DEPARTMENT OF TRANSPORTATION
 FHWA APPROVAL 06/01/15
 APP'D Kristina Ericksen
 DESIGNED Robert Bartron

TRAFFIC CONTROL
 TEMPORARY TRAFFIC SIGNALS
 TITLE LINE 3 (Data Field)

* Two sets of rumble strips shall be placed: one set between signs W3-4 and R2-1, and one set between signs W3-3 and W3-5. Materials, template, hauling, installation, maintenance and removal of the rumble strips are to be by the contractor. Payment shall be subsidiary to the temporary traffic signals.

TYPICAL ASPHALT RUMBLE STRIP DETAILS

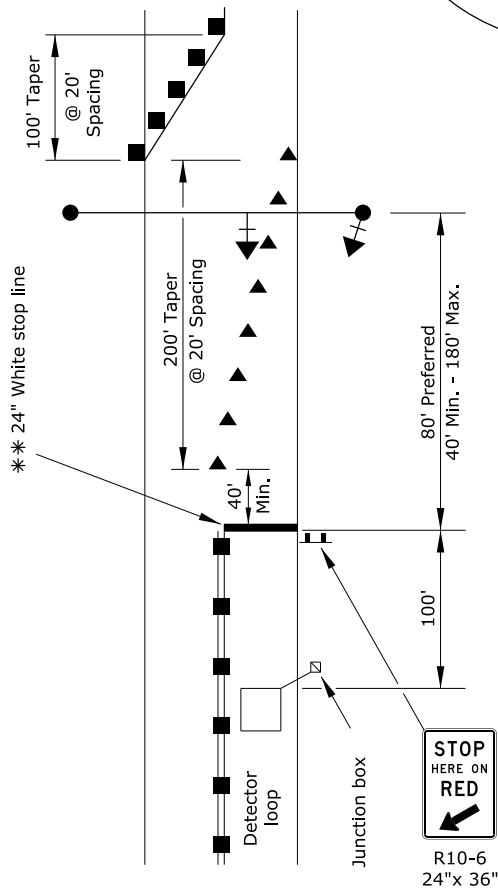
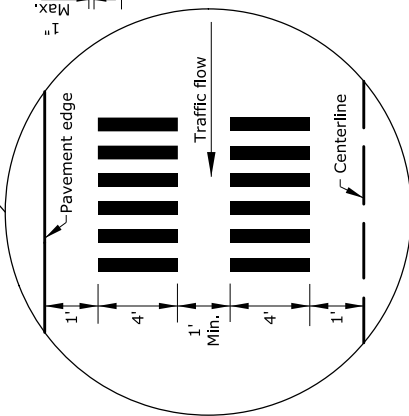
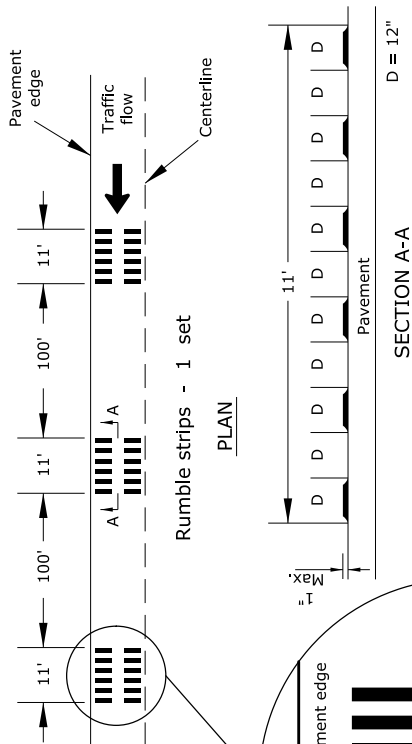

** Stop line created using (6) 4" strips of temporary tape

3					KANSAS DEPARTMENT OF TRANSPORTATION
2					FHWA APPROVAL 06/01/15
1					APP'D Kristina Ericksen
NO.	DATE	REVISIONS	BY	APP'D	DESIGNED Robert Bartron

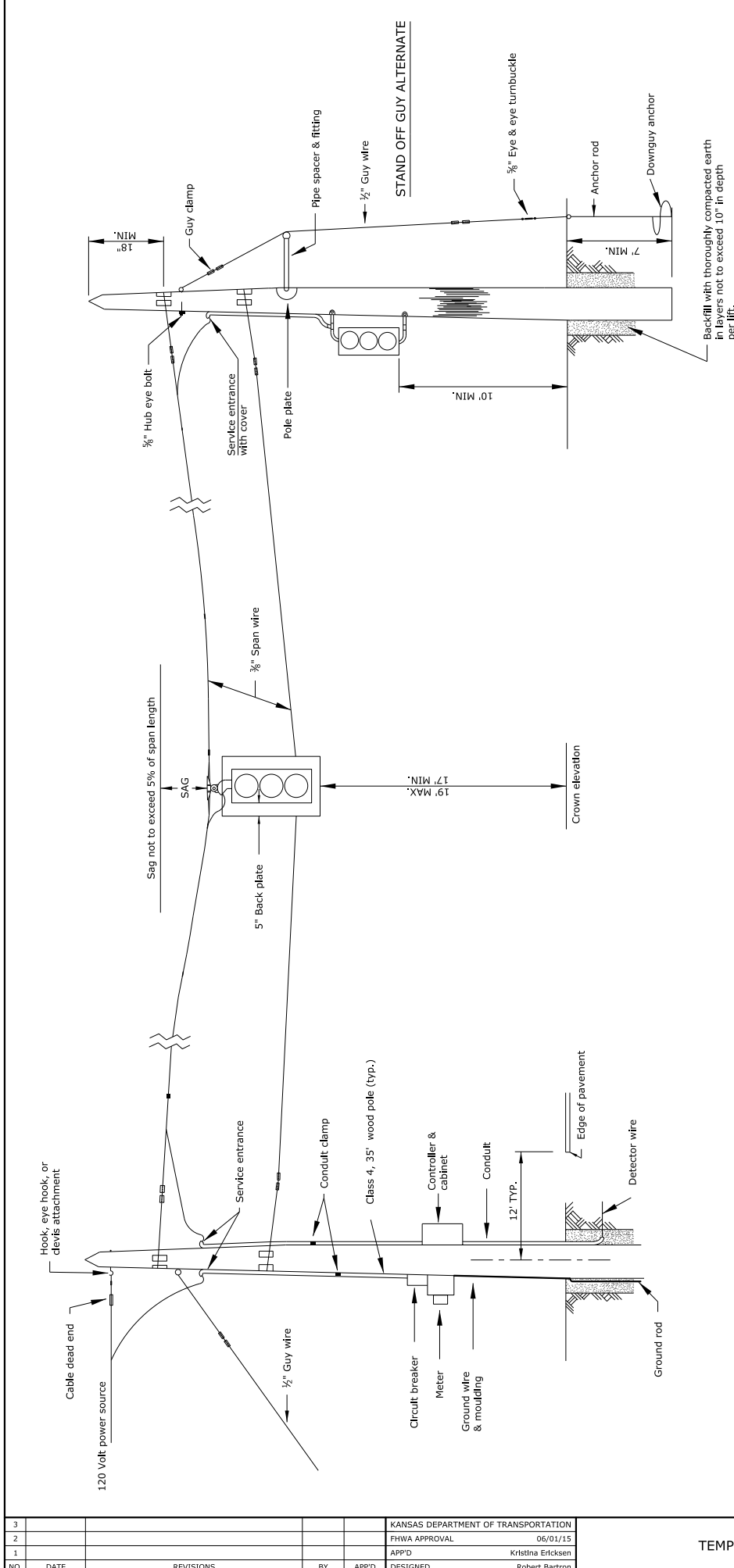

GENERAL NOTES

- The engineer in charge of construction will need to approve all locations for traffic signals to be installed. Final positions & aiming of signal faces to be determined in the field.
- Trailer mounted portable traffic signals may be substituted for span wire signals.
- The traffic signal system shall conform to and be operated according to the requirements of the M.U.T.C.D.
- Contact local utility companies to advise them of installation and coordinate power hook-up if needed.
- All wiring installed shall conform to the national electrical code and local ordinances & requirements.
- The power supply and the operation & maintenance of the signal system shall be the responsibility of the contractor.

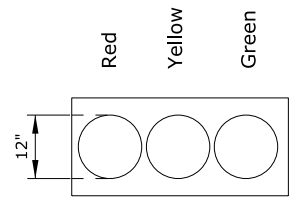

SIGNAL INDICATIONS

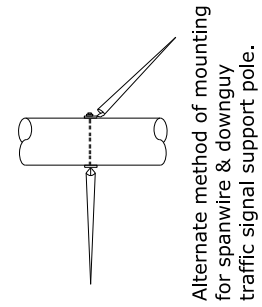

Alternate method of mounting for spanwire & downguy traffic signal support pole.

Note:
See TE734 for additional information.

3					KANSAS DEPARTMENT OF TRANSPORTATION
2					FHWA APPROVAL 06/01/15
1					APP'D Kristina Ericksen
NO.	DATE	REVISIONS	BY	APP'D	DESIGNED Robert Bartron

The control equipment shall be designed in such a manner that the normal dwell condition shall be an "all red" signal display. Upon receipt of a detector actuation from one approach, the signals facing that approach shall cycle to a green indication for a minimum period (minimum green). Subsequent detector actuations from the same direction shall result in additional green time being allocated to that movement (unit extension). In the event that an actuation exists for the direction of travel not having the right of way, a maximum green time setting shall provide a preset time limit for the direction having the right of way.

The control equipment shall provide for different clearance sequences, one for each required phase.

If the green indication has been displayed to one approach to the zone, no vehicle actuation exists on the opposite approach and another actuation occurs during the yellow display to the approach just serviced, the display shall proceed to an all red display for a period of time (red revert) to prevent the display of green - yellow - green indications to the motorist.

If the right of way is to be transferred to another approach, an all red indication shall be provided so that opposing traffic does not meet within the one way zone.

Response to a vehicle actuation from another approach shall be immediate if all timings have expired. In the event that all time settings have not expired at the point at which a vehicle actuation occurs, the system shall continue to provide the appropriate clearance interval timings before acting upon an actuation input.

Vehicle actuations received from the detector at approaches other than that which last received a green indication shall have preference over additional actuations received from the end which last had the right of way in the event that any clearance interval timings have not expired when the actuation(s) occurs. If all timings have expired, response shall be on a first come, first served basis.

All time settings shall be user adjustable and shall be accomplished from the equipment front panel by way of a keyboard and menu screen format. All applicable portions of the KDOT standard specifications for vehicle actuation shall apply except that a standard NEMA conflict monitor shall be acceptable.

Signals shall be capable of actuation. On asphalt roadways, detection loops may be sawed into the road. Commercially made loop mats may also be used. Do not cut loops into concrete pavement. Other types of detection may be used if approved prior to installation by the Engineer. Do not use microwave detection systems in urban areas. Detector shall be set to operate in the locking mode.

If used, detection loops shall be 6' by 6' and have three turns of wire (see detail). Center loops in the lane of traffic and locate 100' behind the stop line. Cut slots in pavement for loops 5/16" wide with 1" minimum depth. Fill slots with asphalt or an approved elastic epoxy sealant (concrete pavement) to within 1/8" of pavement surface. Other than a "western union" type splice or approved connector at their junction, feeder cable and loop wire shall be of continuous run with no splices. The loop and the feeder cable connection shall be twisted 2 turns per foot.

SIGNAL PHASING AND TIMING

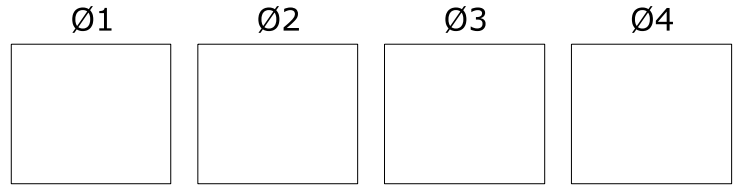
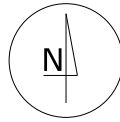

PHASE	MINIMUM GREEN	MAXIMUM GREEN	YELLOW	ALL RED

All times in seconds.
 Normal dwell shall be "all red".
 Unit extension shall be 3.0 seconds.
 Red revert shall be 5.0 seconds.

PHASE	STATIONING
	STOPLINE
	SIGNAL
	SIGNAL
	STOPLINE

LOOP DETECTOR DETAIL

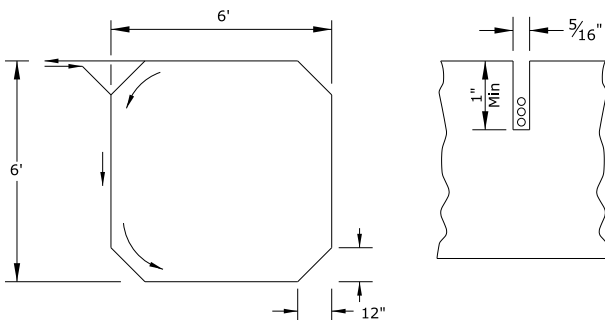

Note: See TE733 for additional information.

3					KANSAS DEPARTMENT OF TRANSPORTATION
2					FHWA APPROVAL 06/01/15
1					APP'D Kristina Ericksen
NO.	DATE	REVISIONS	BY	APP'D	DESIGNED Robert Bartron

TRAFFIC CONTROL
 TEMPORARY TRAFFIC SIGNAL DETAILS
 TITLE LINE 3 (Data Field)

SHEET 1 of 1
 TE734

TYPICAL TEMPORARY STRUCTURE END TREATMENT ON SHOOFLY

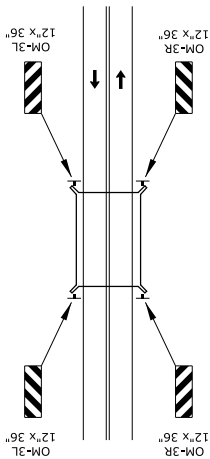

The entire area of object marker shall have ASTM Type III sheeting. The stripes shall slope downward to the traffic side for channelizing.

** Black on orange 24" x 30" chevron signs (W1-8) shall be mounted back to back on the outside edge of shoofly curves with a radius of 1000' or less at the spacing shown below. A minimum of 3 chevrons should be installed per curve.

Suggested chevron spacing	
Curve radius	Max. spacing
1000' - 800'	100'
800' - 450'	80'
LESS THAN 450'	60'

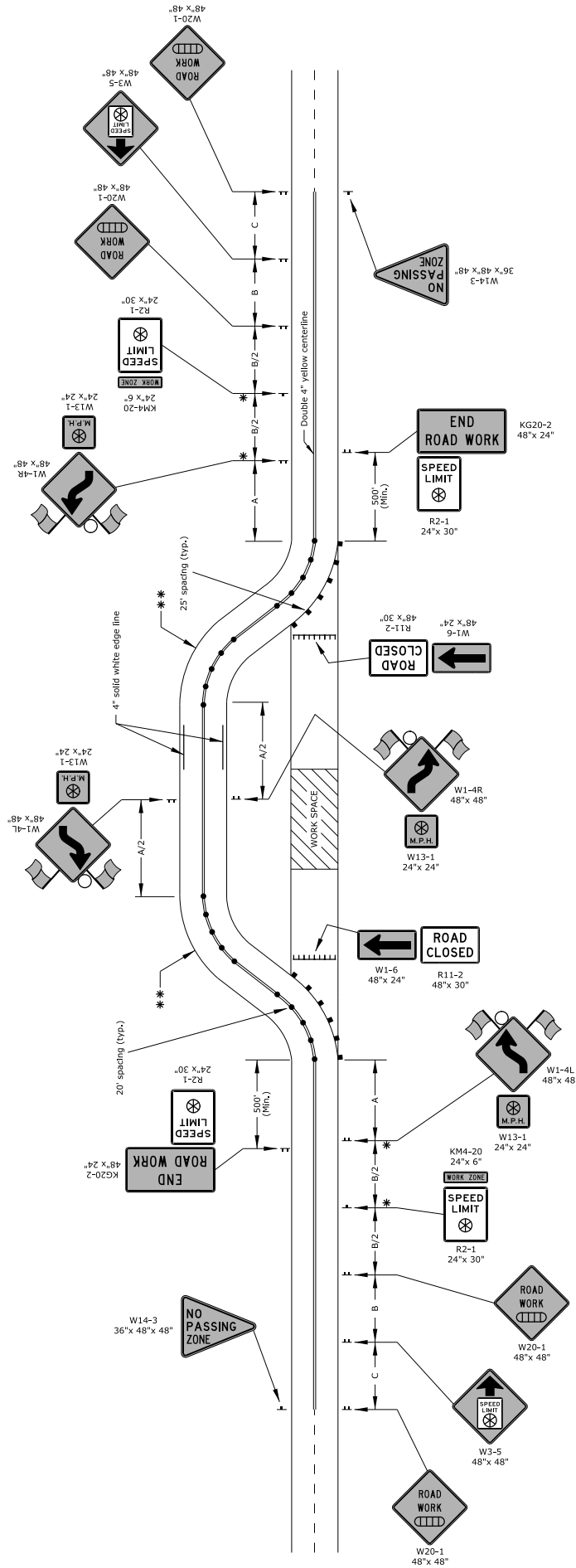

DUAL SPEED DROP

* Add these signs in the sign sequence for dual speed drops. Adjust all other signs and pavement marking accordingly.

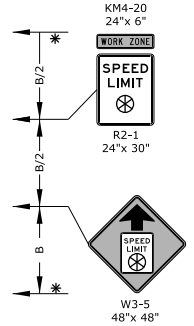

- Channelizing device
- ||| Type 3 barricades
- Bi-directional temp. raised pavement marker (Type 1)
- ▤ Ahead, 1500 ft, or 1 mile
- ⊗ Speed to be determined by the engineer
- Type "A" low intensity warning light

One W24-1 may be used per approach where the tangent distance between two reverse curves is less than 600 ft. If used, use in place of the first W1-4 and eliminate the second.

3					KANSAS DEPARTMENT OF TRANSPORTATION
2					FHWA APPROVAL 06/01/15
1					APP'D Kristina Ericksen
NO.	DATE	REVISIONS	BY	APP'D	DESIGNED Robert Bartron

TRAFFIC CONTROL
SHOOFLY DIVERSION
TITLE LINE 3 (Data Field)

SHEET 1 of 1
TE736

SHIFTING TAPER DETAIL

Add signs and devices as shown for work inside a closed lane that extends near to (or into) the open traffic lane.

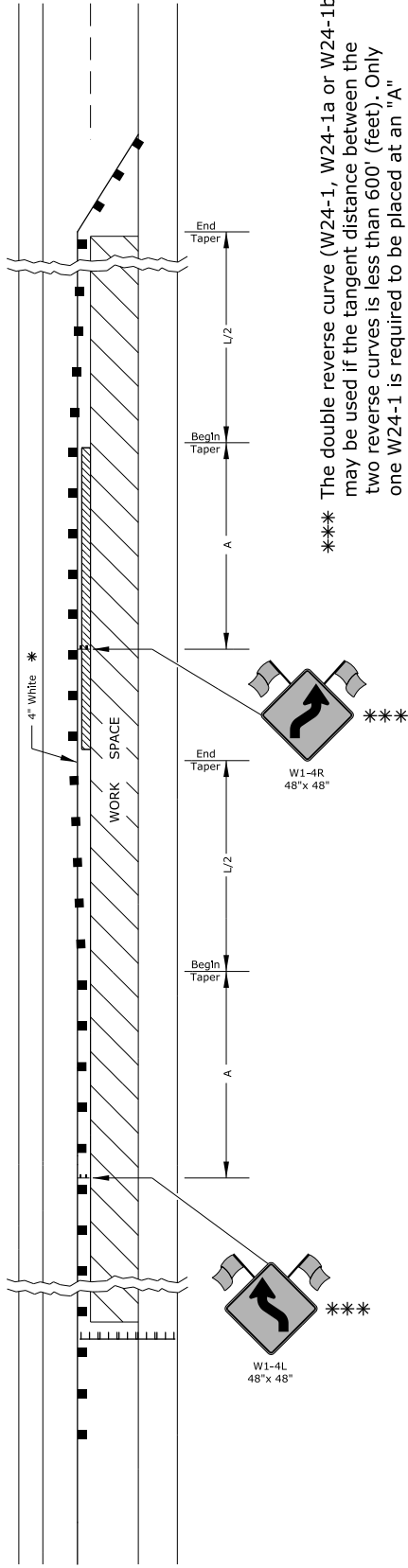

*** The double reverse curve (W24-1, W24-1a or W24-1b) may be used if the tangent distance between the two reverse curves is less than 600' (feet). Only one W24-1 is required to be placed at an "A" distance in advance of the shifting taper.

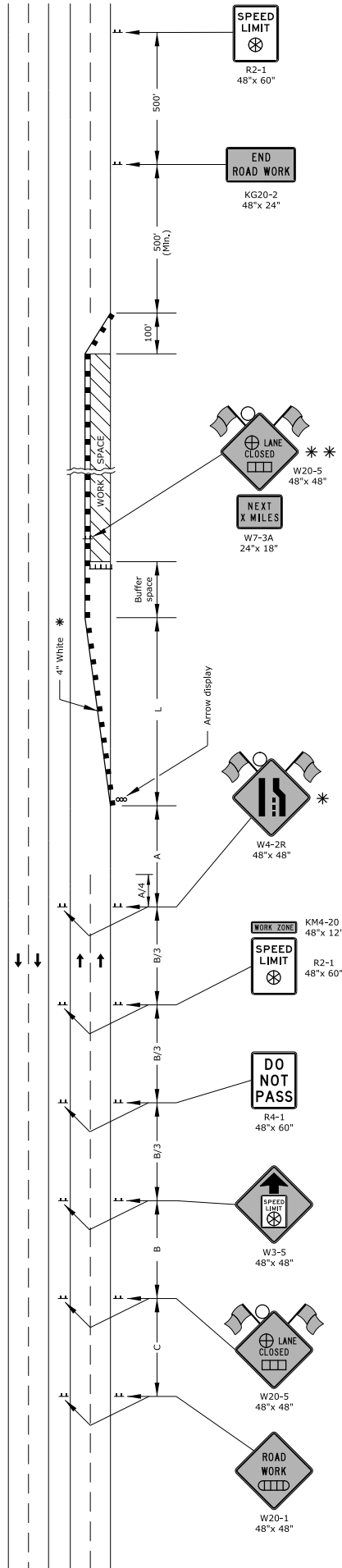

- Type 3 barricades
 - X Length to the nearest whole mile
 - Channelizing device
 - ▤ Ahead, 1500 ft, or 1 mile
 - ▥ Ahead, 1000 ft, 1500 ft, or 1/2 mile
 - ▧ Right or left
 - ⊕ Speed to be determined by the Engineer
 - Type "A" low intensity warning light
- * For left lane closures use W4-2L and yellow edge line along channelizing devices.
 - ** The W20-5 (⊕ Lane Closed) and W7-3A (Next X Miles) signs should be placed at 2 mile increments on a project of 4 miles or longer.
- Left-side signs shall be omitted for a four-lane undivided highway.
- One flagger should be stationed within each multi-lane roadway activity area where work is in a closed lane adjacent to traffic and not separated by a concrete safety barrier system.

3					KANSAS DEPARTMENT OF TRANSPORTATION
2					FHWA APPROVAL 06/01/15
1					APP'D Kristina Ericksen
NO.	DATE	REVISIONS	BY	APP'D	DESIGNED Robert Bartron

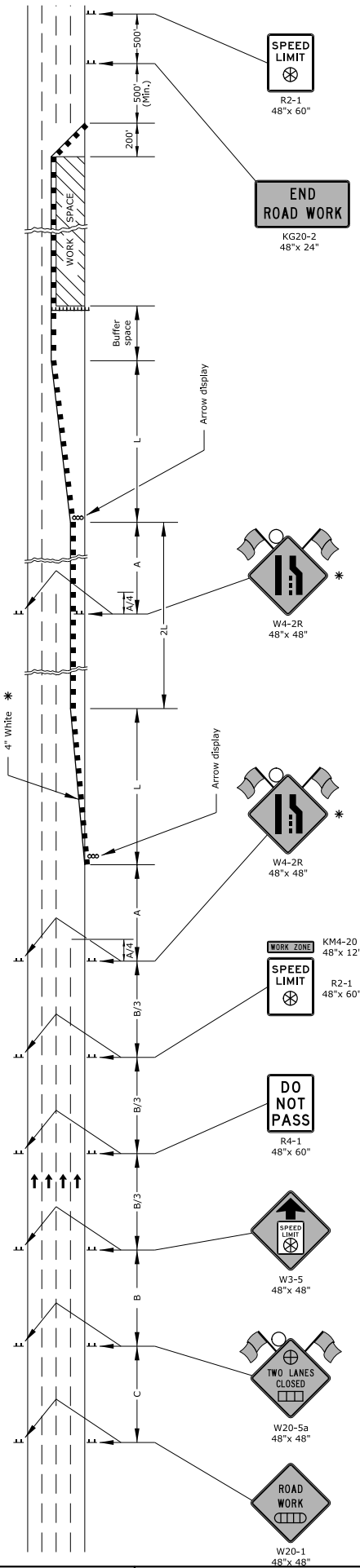

* For left lane closures use W4-2L and yellow edge line along channelizing devices.
 One flagger should be stationed within each multi-lane roadway activity area where work is in a closed lane adjacent to traffic and not separated by a concrete safety barrier system.

- ||| Type 3 barricades
- X Length to the nearest whole mile
- Channelizing device
- ▤ Ahead, 1500 ft, or 1 mile
- ▥ Ahead, 1000 ft, 1500 ft, or 1/2 mile
- ⊕ Right or left
- ⊗ Speed to be determined by the Engineer
- Type "A" low intensity warning light

3					KANSAS DEPARTMENT OF TRANSPORTATION
2					FHWA APPROVAL 06/01/15
1					APP'D Kristina Ericksen
NO.	DATE	REVISIONS	BY	APP'D	DESIGNED Robert Bartron

TRAFFIC CONTROL
 TWO LANES CLOSED
 TITLE LINE 3 (Data Field)

Match line A

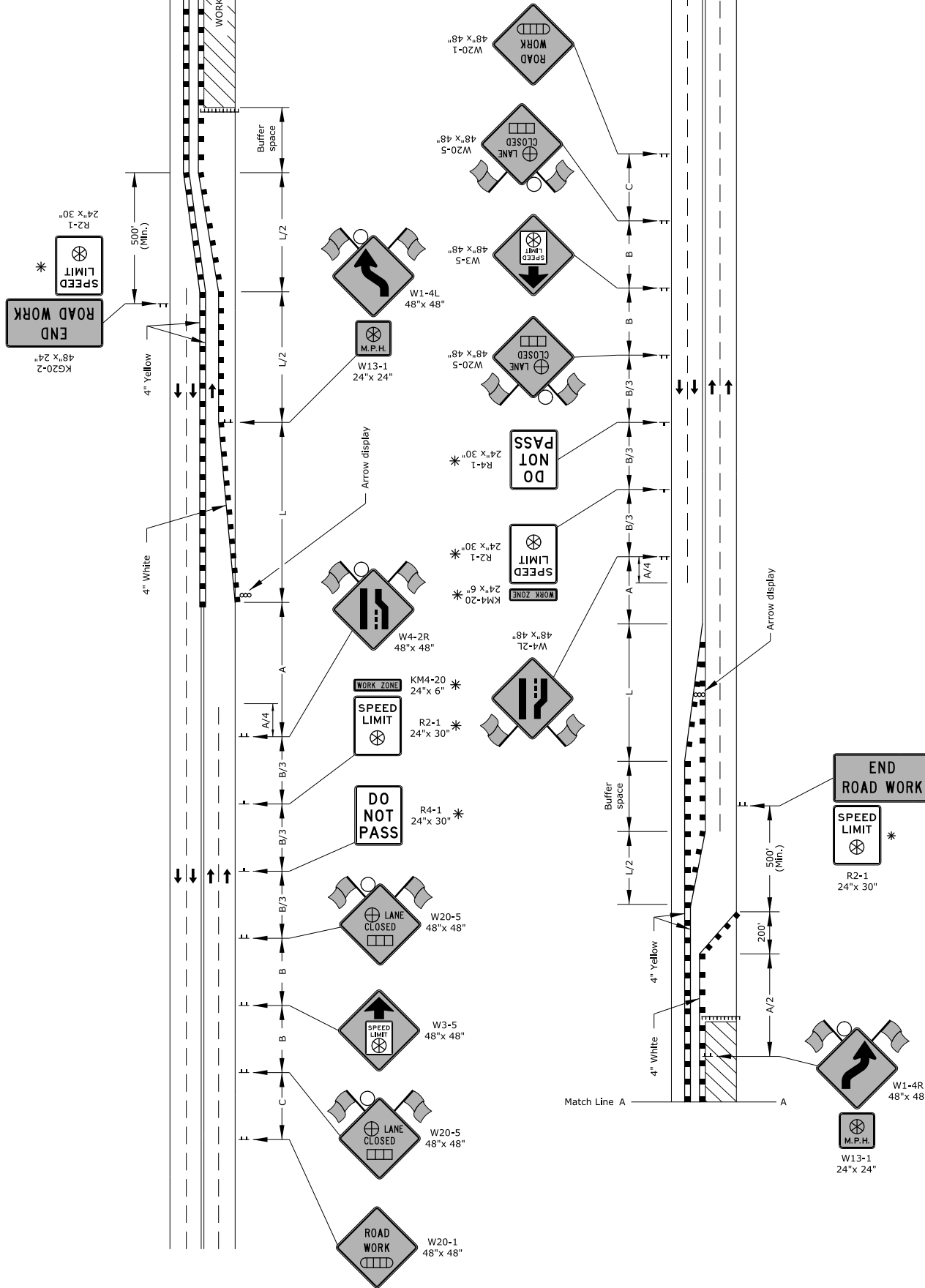

* For speeds greater than 45 mph use freeway / expressway size signs.
 One flagger should be stationed within each multi-lane roadway activity area where work is in a closed lane adjacent to traffic and not separated by a concrete safety barrier system.

- ⏏ Type 3 barricades
- × Length to the nearest whole mile
- Channelizing device
- ▤ Ahead, 1500 ft, or 1 mile
- ▥ Ahead, 1000 ft, 1500 ft, or 1/2 mile
- ⊗ Right or left
- ⊙ Speed to be determined by the Engineer
- Type "A" low intensity warning light

3					KANSAS DEPARTMENT OF TRANSPORTATION
2					FHWA APPROVAL 06/01/15
1					APP'D Kristina Ericksen
NO.	DATE	REVISIONS	BY	APP'D	DESIGNED Robert Bartron

TRAFFIC CONTROL
 CROSSOVER ON UNDIVIDED HIGHWAY
 TITLE LINE 3 (Data Field)