

KDOT UTILITY ACCOMMODATION POLICY

KANSAS
DEPARTMENT OF TRANSPORTATION

2007

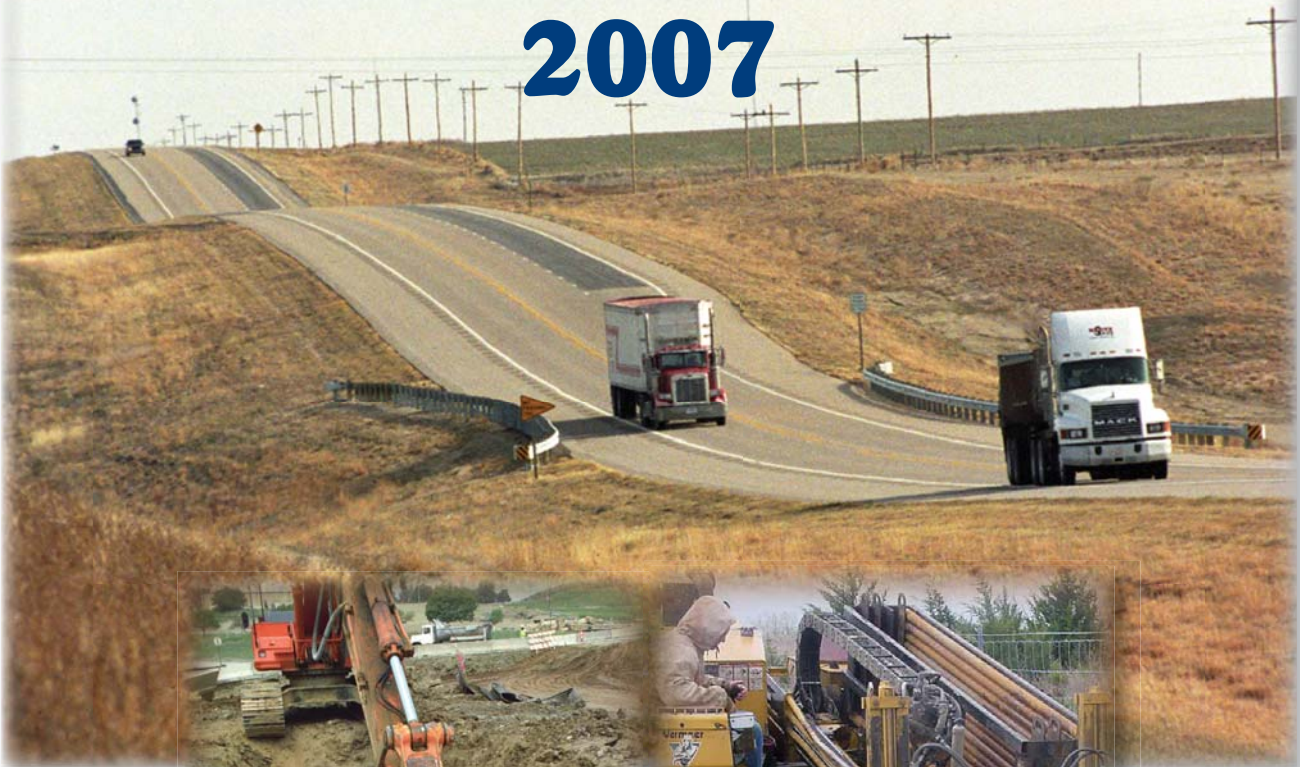

**KANSAS
DEPARTMENT OF TRANSPORTATION
UTILITY ACCOMMODATION POLICY**

2007

**BUREAU OF CONSTRUCTION AND
MAINTENANCE**

www.ksdot.org/hwycont.asp

(This Page Intentionally Left Blank)

KANSAS DEPARTMENT OF TRANSPORTATION

2007 UTILITY ACCOMMODATION POLICY

CERTIFICATION

Pursuant to the power and authority granted to the Kansas Department of Transportation by the laws of the State of Kansas as set forth generally and principally, but not exclusively in K.S.A. 68-404, K.S.A. 68-415, and K.A.R. 36-11-6, I, Deb Miller, Secretary of Transportation declare that the Kansas Department of Transportation has officially adopted this "Utility Accommodation Policy". Adherence to policy requirements and the regulation of the use of highway right-of-way on the Kansas State Highway System is to be authorized through the issuance of Highway Permits, Reimbursable Utility Agreements or in the case of parallel installations along Fully Controlled Access Highways, Utility Permit Agreements.

Dated this 23rd day of October, 2007.

/S/ Deb Miller
Deb Miller
Secretary of Transportation

TABLE OF CONTENTS

	PAGE
INTRODUCTION.....	i
GLOSSARY OF TERMS / DEFINITIONS.....	ii

PART ONE GENERAL POLICY

I. POLICY APPLICATION.....	1-1
II. PERMITS.....	1-4
III. PROTECTION OF TRAVELING PUBLIC.....	1-12
IV. DESIGN CONSIDERATIONS.....	1-13
V. MAINTENANCE AND SERVICING OF UTILITIES	1-14
VI. ROADSIDE LANDSCAPE AND SCENIC ENHANCEMENT.....	1-15
VII. PRESERVATION, RESTORATION, AND CLEANUP	1-16
VIII. SPRAYING, CUTTING AND TRIMMING TREES	1-17

PART TWO UTILITIES ON PERMITTED HIGHWAYS

I. GENERAL PROVISIONS	2-1
II. ABOVEGROUND INSTALLATIONS.....	2-4
III. UNDERGROUND INSTALLATIONS.....	2-6
IV. ENCASEMENT OF UTILITIES	2-9

PART THREE UTILITY ACCOMMODATION POLICY FOR FULLY CONTROLLED ACCESS HIGHWAYS

I. STATEMENT OF POLICY.....	3-1
II. INSTALLATION AND MAINTENANCE GUIDELINES.....	3-3
III. UTILITY PERMIT AGREEMENT.....	3-7

PART FOUR ATTACHMENTS TO BRIDGES AND OTHER STRUCTURES OR INSTALLATIONS NEAR RETAINING WALL SYSTEMS

I. GENERAL PROVISIONS	4-1
II. FULLY CONTROLLED ACCESS HIGHWAYS	4-2
III. PERMITTED HIGHWAYS.....	4-2
APPENDIX.....	5-1
INDEX.....	5-31

INTRODUCTION

(This Page Intentionally Left Blank)

KANSAS DEPARTMENT OF TRANSPORTATION

UTILITY ACCOMMODATION POLICY

INTRODUCTION

This policy is adopted by the Kansas Department of Transportation (KDOT) acting pursuant to the authority granted by the laws of the State of Kansas to establish and administer the State Highway System.

The power and authority of the Secretary of the Kansas Department of Transportation (Secretary) with respect to the accommodation of utilities are as set forth generally and principally in K.S.A. 68-404 and K.S.A. 68-415. These statutes require compliance with state regulations and obtaining a permit for construction of public and private utilities (including pipelines) along, crossing over or under any state highway right-of-way including that acquired for controlled access facilities. K.S.A. 17-1901 and K.S.A. 17-4604 apply to the occupancy of public highway right-of-way by telephone and telegraph companies and by electric cooperatives, respectively.

Utilities occupying public right-of-way, not a part of the State Highway System, such as city connecting links and urban and secondary roads involved in street and/or road construction projects are issued a use permit by the city or county. Any agreement for use of highway right-of-way is to include a statement as to which party will bear the cost of future adjustments or relocations required as a result of street or highway improvements.

Utility or private construction on city connecting links, utilizing public right-of-way, not involved with a street improvement project, requires a Highway Permit with approval from both the City and KDOT. The Highway Permit may be obtained from either the City or KDOT.

If applicable state, rule or regulation sets forth more stringent requirement than this Utility Accommodation Policy, the statute, rule or regulation shall control.

This policy becomes effective upon publication and supersedes all previously published KDOT or former State Highway Commission policies accommodating utility facilities and appurtenances on highway right-of-way.

If application of this policy is not feasible, alternate proposals may be submitted by the Utility Company to the District Engineer for consideration.

The Secretary reserves the right to waive the provisions of this Utility Accommodation Policy. The Secretary may request Federal Highway Administration (FHWA) concurrence when such a waiver is proposed.

GLOSSARY OF TERMS / DEFINITIONS

ACCESS CONTROL: Full or partial restriction of access from abutting lands to and from the highway.

FULL CONTROL OF ACCESS: Prohibits access to the highway except at selected public roads where interchanges are utilized. Crossings at grade or direct private driveway connections are not permitted. Highways with full control of access usually have divided roadways and are classified as Freeways, which includes all Interstate Highways.

PARTIAL CONTROL OF ACCESS: Limits access to the highway. Major public roads generally are served with interchanges, selected public roads may be allowed access at grade as well as some private driveway connections. Such highways usually are classified as Expressways.

BACKFILL: Replacement of soil around and over an underground Utility Company facility.

BORING: Piercing a hole under the surface of the ground without disturbing the earth surrounding the hole. Boring may be accomplished by any KDOT approved manner. Water jetting or puddling is not permitted. Holes may be mechanically bored and cased using a cutting head and a continuous auger mounted inside of the casing. Small diameter holes may be augured and the casing or utility facility pushed in later.

BURY: Placement of the Utility Company facility below grade of roadway, ditch or natural ground to a specified depth.

CARRIER: Pipe directly enclosing a transmitted fluid (liquid or gas).

CASING: A larger pipe enclosing a carrier.

CITY CONNECTING LINK: A routing inside the city limits of a city which: 1) connects a state highway through a city; 2) connects a state highway to a city connection link of another state highway 3) is a state highway which terminates within such city; 4) connects a state highway with a road or highway under the jurisdiction of the Kansas Turnpike authority; or 5) begins and ends within a city's limits and is designated as part of the national system of Interstate and defense highways.

CLEAR ZONE: The total roadside border area, starting at the edge of the traveled way, available for safe use by errant vehicles. This area may consist of a shoulder, recoverable slope, non-recoverable slope, and/or clear run-out area. The desired width is dependent upon the traffic volumes and speeds, and the roadside geometry. See table of Clear Zone Distances in Appendix.

COATING: Material applied to or wrapped around a pipe.

CONDUIT OR DUCT: An enclosed tubular runway for enclosing wires or cables.

DIRECT BURIAL: Installing an underground utility without encasement by plowing or trenching.

DITCH GRADE: Original plan grade, not silted in.

ENCASEMENT: Structural element surrounding a pipe or cable.

FLEXIBLE PIPE: A plastic, fiberglass, or metallic pipe having a large ratio of diameter to wall thickness which can be deformed without undue stress. Copper or aluminum pipe shall be considered as flexible pipe.

FREEWAY: A highway with full control of access. All Interstate Highways and highways which do not have any at grade entrances or crossings are classified as Freeways. These facilities usually have divided roadways.

FRONTAGE ROAD: A public street or road located adjacent to a freeway or arterial highway to serve abutting property and local areas.

GROUNDING: Connected to earth or to some extended conducting body which serves instead of the earth whether the connection is intentional or accidental.

GROUT: A cement mortar or slurry of fine sand or clay.

HIGHWAY: The entire area within the right-of-way dedicated as a public way for the purpose of vehicular travel.

INTERSTATE HIGHWAYS: National system of Interstate and Defense Highways with full control of access, selected by joint action of the State Highway Departments of each State and adjoining States, subject to the approval of the United States Secretary of Transportation.

JACKING: The installation of small pipes by the use of hydraulic jacks or rams to push the pipe under the traveled surface of the road.

KDOT STANDARD SPECIFICATION: Standard Specification for State Road and Bridge Construction. The specification are located online at www.ksdot.org/burConsMain/specprov/specifications.asp

MANHOLE: An opening to an underground utility system which workers or others may enter.

MEDIAN: The portion of a divided highway separating the roadways for movement of traffic in opposite directions.

MONITORING WELL: A well installed and used for ground water investigation and/or remediation of environmental pollution.

NATURAL GAS PIPE LINES:

DISTRIBUTION SYSTEM: Pipeline other than a gathering or transmission line.

SERVICE LINE: Distribution line that transports gas from a common source of supply to a customer meter.

TRANSMISSION SYSTEM: Pipeline other than a gathering line that transports gas from a gathering line or storage facility to a distribution center or storage facility. Operates at a hoop stress of 20 per cent or more of the Specified Minimum Yield Strength (SMYS).

NORMAL: Crossing at a right angle.

PERMITS:

HIGHWAY PERMITS: Executed for all Utility Company facilities or ROW Occupants located on state highway right-of-way, except for parallel installations on Fully Controlled Access Highways.

REIMBURSABLE UTILITY AGREEMENTS: Executed when Utility Company facilities are located on private right-of-way and must be relocated for highway improvements.

UTILITY PERMIT AGREEMENTS: Executed permits with a negotiated contract for parallel occupancy by Utility Companies on Fully Controlled Access Highways.

PIPE: A tubular product made as a production item for sale. Cylinders formed from plate in the course of the fabrication of auxiliary equipment are not pipe.

PRESSURE: Relative internal pressure in PSIG (Pounds per Square Inch Gauge).

PRIVATE LINES: Privately owned facilities which convey or transmit commodities as defined in this section but devoted exclusively to private use.

PUBLIC LINES: Facilities which convey or transmit commodities as defined in this section and directly or indirectly serve the public or any part thereof.

REMEDICATION WELL: A well installed and used for remediation of environmental pollution.

RETAINING WALL SYSTEMS: Retaining wall systems shall include Mechanically Stabilized Earth (MSE) Walls, Modular Block Walls (MBW), Cast-in-Place Walls, Crib Walls, T-Walls and etc.

RIGHT-OF-WAY: Land, property or interest therein, usually in a strip, acquired for or devoted to highway transportation purposes.

ROADWAY: That portion of the highway extending from outside shoulder line to outside shoulder line or between curb lines. Divided highways are considered to have two roadways.

SCENIC OVERLOOK: A roadside area provided for motorists to stop their vehicles beyond the shoulder, primarily for viewing the scenery in safety.

SHOULDER: That portion of roadway contiguous with the traveled way for accommodation of stopped vehicles and emergency use.

TRAFFIC CONTROL PLAN: A signing plan for controlling traffic when work is being performed on the highway or within the "Clear Zone". The signing plan will be in accordance with the Manual on Uniform Traffic Control Devices and the State of Kansas Traffic Control Standards. When ever the Traffic Control Standards conflicts with the Manual, the Standards shall govern. The signing plan will also address storage of materials and parking for work crew vehicles on the right-of-way when appropriate.

TRAVELED WAY: The portion of the roadway for the movement of vehicles, exclusive of shoulder and auxiliary lanes.

TRENCHED: Installed in a narrow excavation.

TUNNELING: Excavating the earth ahead of a large diameter pipe by one or more of the following processes:

- 1) The earth ahead of the pipe will be excavated by men using hand tools while the pipe is pushed through the holes by means of jacks, rams, or other mechanical devices.
- 2) The excavation is carried on simultaneously with the installation of tunnel liner plates.
- 3) The tunnel liner plates are installed immediately behind the excavation as it progresses and are assembled completely from the inside.

UTILITIES: All privately, publicly or cooperatively owned lines, facilities and systems for producing, transmitting or distributing communications, power, electricity, light, heat, gas, oil, crude products, water, steam, waste, storm water, and other similar commodities, including fire and police signal systems and street lighting systems which directly or indirectly serve the public.

UTILTIY COMPANY AND ROW OCCUPANT: Utility Company is a Company placing their utility on KDOT right-of-way. ROW occupant is any one who is utilizing KDOT right-of-way for placement of utility or other approved item.

WALL SYSTEM: refer to Retaining Wall Systems

(This Page Intentionally Left Blank)

PART ONE



GENERAL POLICY



**PART ONE
GENERAL POLICY**

	PAGE
I. POLICY APPLICATION.....	1-1
A. GENERAL	1-1
B. FEE	1-2
C. PERMIT REVOCATION	1-2
D. LIABILITY	1-2
E. REPLACEMENT OR CHANGE OF USE OF FACILITY	1-2
F. CHANGE IN OWNERSHIP	1-3
G. ABANDON OR RETIRE IN PLACE	1-3
H. HIGHWAY CONSTRUCTION PROJECTS	1-3
I. DISCHARGE OF WASTE MATERIAL.....	1-3
J. NON-COMPLIANCE.....	1-4
II. PERMITS	1-4
A. GENERAL	1-4
B. APPLICATIONS.....	1-6
C. KDOT DISTRICT AND AREA OFFICES.....	1-7
III. PROTECTION OF TRAVELING PUBLIC.....	1-12
A. TRAFFIC CONTROL.....	1-12
B. STORAGE AND PARKING.....	1-13
IV. DESIGN CONSIDERATIONS.....	1-13
A. DESIGN.....	1-13
B. MATERIALS	1-13
C. FUTURE EXPANSION	1-13
D. CATHODICALLY PROTECTED UTILITIES	1-13
V. MAINTENANCE AND SERVICING OF UTILITIES	1-14
A. UTILITY OWNER'S RESPONSIBILITY	1-14
B. EMERGENCY MAINTENANCE	1-14
VI. ROADSIDE LANDSCAPE AND SCENIC ENHANCEMENT.....	1-15
A. SCENIC AREAS.....	1-15
B. VISUAL CONTROLS	1-15
C. PROTECTION OF VEGETATION.....	1-16
VII. PRESERVATION, RESTORATION, AND CLEANUP	1-16
A. DISTURBED AREAS	1-16
B. DRAINAGE FACILITIES.....	1-16
C. CLEANUP.....	1-17
VIII. SPRAYING, CUTTING AND TRIMMING TREES	1-17
A. PERMIT REQUIRED.....	1-17
B. CHEMICAL BRUSH CONTROL	1-17
C. TREE PRUNING	1-18

IX.	PERMITS – OTHER USES OF RIGHT-OF-WAY.....	1-18
A.	BANNERS	1-18
B.	CATTLE CROSSING.....	1-18
C.	FENCING.....	1-18
D.	FLOWER PLANTING AND LANDSCAPING.....	1-18
E.	FOSSIL AND ROCK HUNTING	1-19
F.	GRAIN STORAGE ON MIXING STRIPS AND OTHER KDOT PROPERTY	1-19
G.	MAIL BOX INSTALLATION	1-19
H.	PAY PHONES AT REST AREAS	1-19
I.	SURVEYORS	1-19
J.	WELCOME SIGNS, CITY OWNED	1-19

(This Page Intentionally Left Blank)

PART ONE - GENERAL POLICY

I. POLICY APPLICATION

A. GENERAL

1. This policy applies to the location, construction, maintenance, removal and relocation of all private, public and cooperatively owned utilities within the highway right-of-way under the jurisdiction of the Secretary of the Kansas Department of Transportation (Secretary).
2. Utilities include lines, facilities, and systems for producing, transmitting or distributing communications, power, electricity, Cable TV, light, heat, gas, oil, crude products, water, steam, waste, storm water not connected with highway drainage, and other similar commodities, including fire and police signal systems and street lighting and traffic control systems, which directly or indirectly serve the public.
3. A permit allowing a Utility Company the privilege of placing its facilities in or on the highway right-of-way does not constitute any permanent right of use. Removal, remodeling, maintenance or relocation of the facilities will be promptly accomplished by the owner at no cost to the KDOT.
4. Private Utility Company lines shall not occupy the highway right-of-way except where necessary to cross the highway.
5. Commercial towers and antennas for private and/or public utilities are not permitted to occupy the highway right-of-way, except when adverse economic impacts are documented and approval is granted by the Secretary or the utilities provide service to maintain highway facilities. Please refer to Small Cell Antenna and Tower - Addendum for small cell antenna installations, page 5-15a.
6. Utility Companies who utilize subcontractors are responsible for subcontractor compliance with KDOT standard specifications, regulations and permit issued pursuant to this Policy. Unsatisfactory work will be rejected and result in permit revocation and may result in denial of future Highway Permits.
7. Subcontractors must carry the required liability insurance unless the subcontractor is covered by the Utility Company insurance.
8. Utility Companies and subcontractors shall follow industry accepted construction and safety practices and follow applicable statutes and regulation(s).

9. Periodic updates will be made to the D.O.T. Forms No. 304 "Highway Permit" and No. 310 "Attachment to Bridges and Other Structures or Installations near Retaining Wall Systems". The current version of the forms applies.
10. The Secretary may waive requirements of this policy in writing for utility lines which service facilities required for operating the highway.
11. An approved and signed copy of the Highway Permit must be on the premises at the start and during the period any work is performed.
12. The Utility Company and its subcontractor(s) are responsible for contacting Dig Safe and for securing additional permits, (i.e. permits for crossing railroad right-of-way, dikes, levees and/or pipeline easement(s)).

B. FEE

1. A fee is not required for processing and issuing a Highway Permit.
2. A fee may be required for processing and issuing a Utility Permit Agreement for use of Fully Controlled Access Highway right-of-way.

C. PERMIT REVOCATION

In lieu of bond, the Secretary may revoke the permit and remove any work performed for failure to complete a project as described in the Permit or failure to comply with this policy. The Utility Company or ROW Occupant shall reimburse the Secretary for any cost incurred by the Secretary to restore the right-of-way. The Secretary will not authorize any other highway permits for the Utility Company or ROW Occupant until the Utility Company or ROW Occupant has either reimbursed the Secretary or restored the right-of-way.

D. LIABILITY

1. Liability insurance shall be provided as more specifically outlined in the Highway Permits (D.O.T. Form No. 304 - Section 10 and D.O.T. Form No. 310 - Section 9), which are included in the Appendix.
2. The Utility Company or ROW Occupant assumes all risk and liability for accidents and damages that may occur to persons or property from work performed under a Highway Permit, Utility Agreement or Lump Sum Agreement. The Utility Company or ROW Occupant shall comply with the Underground Utility Damage Prevention Act (K.S.A. 66-1801 et seq.).
3. KDOT shall not be liable for damage to any utility not installed in the location authorized by any permit or agreement issued pursuant to this UAP.

E. REPLACEMENT OR CHANGE OF USE OF FACILITY

Replacement or change of use of existing Utility Company facilities with the same facilities or facilities of a different type, or design is to be considered as a new utility installation requiring a new permit, and all work shall adhere to this policy.

F. CHANGE IN OWNERSHIP

Each KDOT District shall be notified in writing of the names and addresses of the new owners within 30 days after a Utility Company changes ownership.

G. ABANDON OR RETIRE IN PLACE

The Utility Company shall notify KDOT when the utility has been abandoned or retired in place and is responsible for all costs associated with removal (or making safe in place) abandoned or retired in place utility. The Utility Company shall remove all above ground structures, pedestals, markers, manholes, and other structures or installations deemed necessary by the District Engineer or designee.

H. HIGHWAY CONSTRUCTION PROJECTS

Utilities must be relocated six weeks prior to construction project bid lettings. Utility Companies must contact the District Engineer or designee prior to starting relocation work. Relocation of utilities prior to construction project bid letting may require clearing and grubbing of trees and vegetation. Permission to leave debris for disposal may be granted by the District Engineer or designee. If not feasible as determined by the District Engineer or designee to have all utilities moved prior to a project bid letting, the Utility Company will coordinate with the contractor during the construction of the project. If utilities are not moved in a reasonable time following a request by KDOT, KDOT may move the utilities. KDOT may submit an itemized statement of costs for the relocation to Utility Company and Utility Company shall reimburse KDOT upon receipt of this statement.

I. DISCHARGE OF WASTE MATERIAL

Applications for a Highway Permit, Utility Permit Agreement, or Reimbursable Utility Agreement for the installation of utility facilities which may discharge materials into the waters of the United States or waters of the State shall comply with all applicable requirements of the Corps of Engineers, Federal, State and local environmental protection agencies with jurisdiction. A copy of any necessary permit or authorization shall be provided to the District Engineer or designee.

J. NON-COMPLIANCE

Non-compliance with any of the terms of this Utility Accommodation Policy or any permit, license or agreement issued pursuant to the Policy may be considered as cause for shut down of operations until compliance is assured to the satisfaction of the District Engineer or designee or revocation of the permit at the discretion of the District Engineer or designee. The cost of any work required by KDOT in the removal of non-complying construction will be assessed against the Utility Company or ROW Occupant.

II. PERMITS

A. GENERAL

1. Highway Permits are required when utility facilities are installed, relocated, removed or maintained along, crossing over or under all highway right-of-way. The Secretary has delegated authority to the District Engineer or designee to approve and execute Highway Permits. All such permits are approved through the District Engineer or designee of the appropriate KDOT District Office.
 - a. A certificate of liability insurance shall be on file with the KDOT for each permit. Signing and all work shall be subject to the requirements of this Utility Accommodation Policy and the Highway Permits (D.O.T. Forms No. 304 "Highway Permit" and No. 310 "Attachment to Bridges and Other Structures or Installations near Retaining Wall Systems").
 - b. On City Connecting Links, a Highway Permit must be obtained for work on the right-of-way other than routine maintenance or a KDOT approved construction project. Permit forms may be obtained from either KDOT or the City. The Permit requires the signature of both KDOT and the City. The issuing party, either the City or District Office, will distribute copies of the Highway Permit to the Utility Company or ROW Occupant, District Office and City. The District Office will forward a copy to the Bureau of Construction and Maintenance.
 - c. Changes in the scope of work on a Highway Permit will require prior review and approval by the District Engineer or designee.

d. "Standing Permits" may be granted, at the discretion of the District Engineer or designee to Utility Company, Engineering Firms or ROW Occupant with satisfactory performance records. "Standing Permits" may be issued for a maximum period of one year and are for routine and normal maintenance. Large projects are outside the scope of routine maintenance.

The Utility Company, subcontractor or ROW Occupant shall contact the District Engineer or designee prior to conducting any normal maintenance type work on the highway right-of-way covered by a "Standing Permit". Location and dates of the beginning and completion of the proposed work will be logged and documented on the "Standing Permit". Approval of the work may be given by telephone.

2. Utility Permit Agreements are executed permits with a negotiated contract for qualifying utilities for parallel occupancy on the right-of-way of Fully Controlled Access Highways. See Part Three - "Utility Accommodation Policy for Fully Controlled Access Highways" for details.
3. Reimbursable Utility Agreements are executed when Utility Company facilities are located on private right-of-way or private easements and must be relocated, adjusted or removed because of highway improvements. Costs for such utility changes are to be reimbursed by KDOT. Such agreements are prepared and approved by the KDOT Bureau of Design.
 - a. A properly executed Reimbursable Utility Agreement will be considered to be a Highway Permit and all utility facilities relocated or adjusted on highway right-of-way will conform to this Utility Accommodation Policy. KDOT Construction personnel will prepare a "Highway Permit" for reimbursable utility relocations. These "Highway Permits" are for KDOT's internal use and Utility Company endorsement is not required. These "Highway Permits" will be filed by KDOT the same as any other "Highway Permit".
 - b. 23 C.F.R. 645 Subpart A prescribes the policies, procedures and reimbursement provisions for the adjustment and relocation of utility facilities on Federal-Aid projects. The Internet site for this publication is at www.fhwa.dot.gov/legsregs.
 - c. Utility relocations accomplished under a highway construction project, where costs are not reimbursable, will require a Highway Permit along with the required liability insurance.
 - d. KDOT will reimburse the cost for municipally owned like-kind utility adjustments required by KDOT initiated bridge and highway improvement projects if the municipality population is not greater than 2500.

- e. Any rural water district meeting the requirements of K.S.A. 68-415(c) shall be reimbursed for the district's costs for relocating their water lines or if the Secretary relocates the water lines, the water district shall not be required to reimburse the Secretary for such cost.

B. APPLICATIONS

1. Application and plans shall be submitted, for review and approval to the Area Engineer. The application shall show the location of the utility by route, county, reference marker, section, township and range; and position of the utility within the right-of-way noting all construction details such as depths, type of materials, operating pressures, voltages, vertical and horizontal clearances, etc. Plans shall consist of five (5) sets of 8 1/2" x 11" or 11" x 17" sheets; 24" x 36" sheets will only be accepted when smaller sheets would be illegible. Approved requests to install, maintain, relocate or remove a utility within public highway right-of-way, other than parallel occupancy on Fully Controlled Access Highways, shall be authorized by a Highway Permit- Use of Highway Right-of-Way (D.O.T. Form No. 304).
2. Permit applications for pipelines carrying hazardous materials shall display the names of company officials who can be contacted on a 24-hour basis in case of any emergency. The Utility Company shall notify the KDOT District of all changes in the calling list within 7 days of such change.
3. A copy of the "Highway Permit - Use of Highway Right-of-Way" (D.O.T. Form No. 304); which also is used for City Connecting Links, is included in the Appendix. Major requirements are listed on this form, which include, among other things, providing Liability Insurance. No insurance will be required for Local Units of Government or other state agencies.
4. Applications for Utility Permit Agreements for parallel occupancy on Fully Controlled Access Highways will be as outlined in Part Three -"Utility Accommodation Policy for Fully Controlled Access Highways" of this policy.
5. Part Four of this Policy describes requirements for applications for utility attachment to bridges and structures. A copy of the Highway Permit - Attachment to Bridges and Other Structures or Installation near Retaining Wall Systems (D.O.T. Form No. 310) is included in the Appendix.
6. Utility projects involving work requiring permits for both the Highway Right-of-Way, (D.O.T. Form No. 304) and Attachment to Bridges and Other Structures or Installations near Retaining Wall Systems, (D.O.T. Form No. 310) shall, whenever feasible, be cross-referenced and submitted at the same time.

7. Permit applications for underground utilities that use cathodically protected pipes shall submit plans of the cathodic protection design and maintenance. The plans should note groundbed and pipeline crossings near underground highway structures and detail the steps proposed to provide for the safety of those structures. The KDOT Bridge Department will review these plans and may issue needed recommendation. After the review of the cathodic protection plans for an underground utility, KDOT may require additional inspections along the pipelines where interference could jeopardize the structural integrity of an underground highway structure.

C. KDOT DISTRICT AND AREA OFFICES

Applications for Highway Permits may be obtained at any KDOT District Office or KDOT Area Office.

A map showing KDOT District and Area boundaries and a list of addresses and telephone numbers for each office is listed on the following pages.

Applications may be submitted to KDOT Area Offices.

KDOT MAINTENANCE AREAS

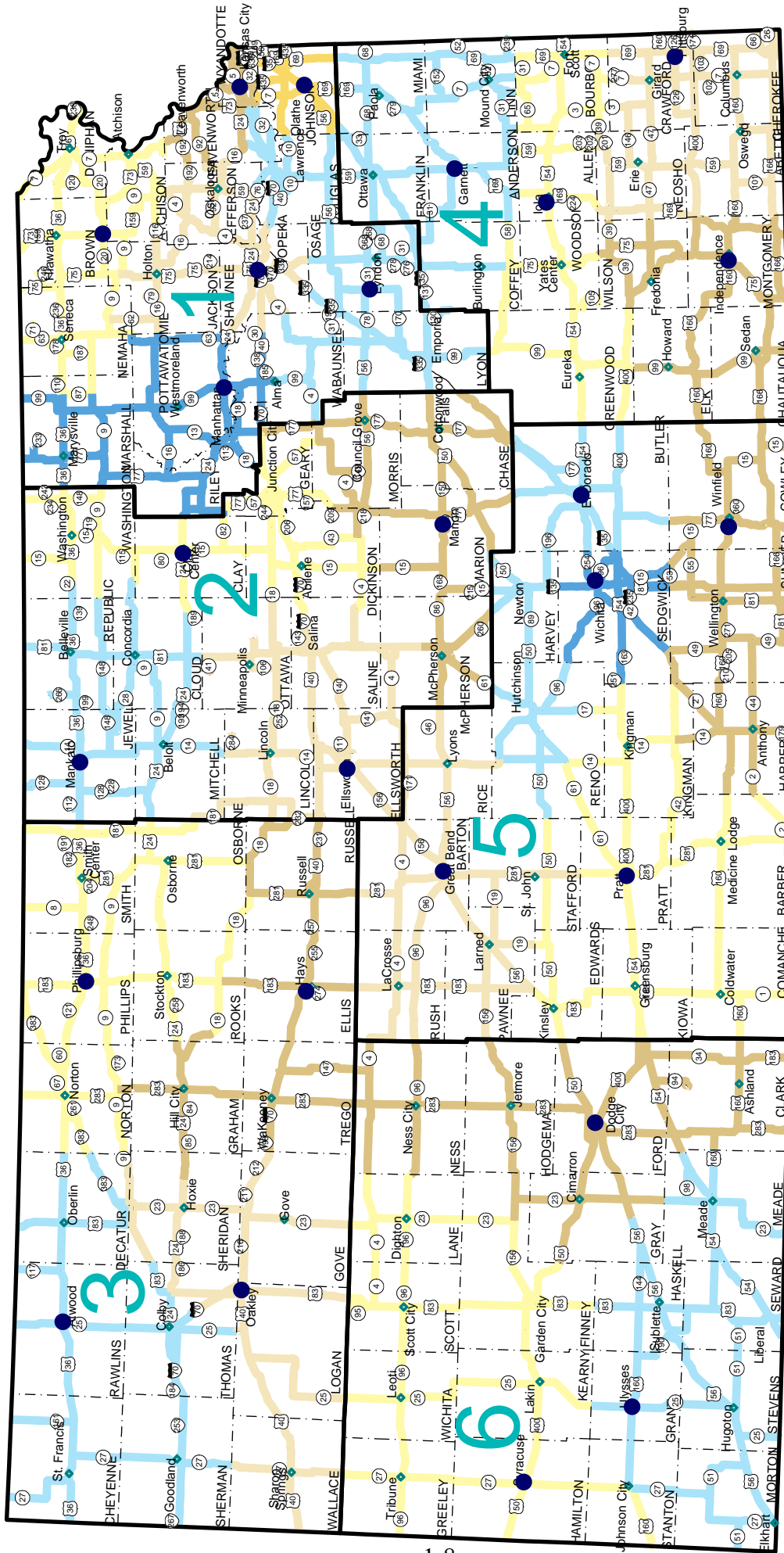

KDOT makes no warranties, guarantees, or liability for accuracy of this information and assumes no liability for errors or omissions.

- Area 1
- Area 2
- Area 3
- Area 4
- Area 5
- Area 6
- Area Office

**KANSAS DEPARTMENT OF TRANSPORTATION
DISTRICT AND AREA OFFICES**

<u>DISTRICT/ AREA</u>	<u>LOCATION</u>	<u>ADDRESS</u>	<u>TELEPHONE</u>
District I (North East)	Topeka	121 W. 21st St. 66605-1429	785-296-3881 Fax: 785-296-1162
Area 1	Horton	1686 E. 1st Ave. East Box 151 66439-0151	785-486-2142 Fax: 785-486-3788
Area 2	Osage City	322 S. Martin Box 212 66523-9630	785-528-3128 Fax: 785-528-3803
Area 3	Bonner Springs	650 N. K-7 Hwy 66012-1736	913-721-2960 Fax: 913-721-5441
Area 4	Topeka	101 Gage Boulevard 66606-2021	785-296-2291 Fax: 785-296-1096
Area 5	Wamego	1425 W. US-24 66547	785-456-2353 Fax: 785-456-9851
Area 6	Olathe	1290 S. Enterprise 66061-5355	913-764-0987 Fax: 913-782-5914
District II (North Central)	Salina	1006 N. 3rd St. Box 857 67402-0857	785-823-3754 Fax: 785-823-1649
Area 1	Clay Center	731 West Crawford 67432-2339	785-632-3108 Fax: 785-632-3337
Area 2	Mankato	E. on US-36 Box 220 66956-0220	785-378-3166 Fax: 785-378-3800
Area 3	Marion	US-56 & Cedar St. Box 236 66861-0236	620-382-3717 Fax: 620-382-2339
Area 4	Ellsworth	202 W 15 th Street Box 147 67439-0147	785-472-4447 Fax: 785-472-4676

<u>DISTRICT/ AREA</u>	<u>LOCATION</u>	<u>ADDRESS</u>	<u>TELEPHONE</u>
District III (North West)	Norton	312 S. Second St. Box 350 67654-0350	785-877-3315 Fax: 785-877-2531
Area 1	Phillipsburg	1 mile S. of US-36 & US-183 Box 268 67661-0268	785-543-2163 Fax: 785-543-5914
Area 2	Atwood	E. on US-36 Box 156 67730-0156	785-626-3258 Fax: 785-626-3185
Area 3	Hays	1811 W. Frontier Rd. Box 760 67601-0760	785-625-9718 Fax: 785-625-3846
Area 4	Oakley	Jct. US-40 & 83 Box 516 67748-0516	785-672-3113 Fax: 785-672-4985
District IV (South East)	Chanute	411 W. Fourteenth St. Box 498 66720-0498	620-431-1000 Fax: 620-431-4406
Area 1	Iola	1720 N. State Box 366 66749-0366	620-365-2161 Fax: 620-365-2402
Area 2	Garnett	Jct. of US-59 & K-31 Box 325 66032-0325	785-448-5446 Fax: 785-448-2486
Area 3	Independence	W. on US-75 Box 884 67301-0884	620-331-3760 Fax: 620-331-7017
Area 4	Pittsburg	1813 W 4 th ST Box 104 66762-0104	620-231-7560 Fax: 620-231-1149

<u>DISTRICT/ AREA</u>	<u>LOCATION</u>	<u>ADDRESS</u>	<u>TELEPHONE</u>
District V (South Central)	Hutchinson	500 N. Hendricks Box 769 67504-0769	620-663-3361 Fax: 620-663-1804
Area 1	Pratt	309 Iowa Box 409 67124-0409	620-672-7494 Fax: 620-672-7678
Area 2	El Dorado	205 Oil Hill Rd. Box 888 67042-0888	316-321-2880 Fax: 316-321-1702
Area 3	Winfield	7093 US 160 Box 639 67156-0639	620-221-3370 Fax: 620-221-1633
Area 4	Great Bend	E. on US-56 & Kiowa RD Box 86 67530-0086	620-793-5408 Fax: 620-793-6216
Area 5	Wichita	3200 E. 45th St. N. 67220-1432	316-744-1271 Fax: 316-744-3064
District VI (South West)	Garden City	Campus Dr. & US-50 Box 619 67846-0619	620-276-3241 Fax: 620-276-2333
Area 1	Syracuse	N. of Syracuse on Main St. Box 1417 67878-0080	620-384-7821 Fax: 620-384-7687
Area 2	Ulysses	S. of Ulysses on US-160 Box 362 67880-0362	620-356-1531 Fax: 620-356-4361
Area 3	Dodge City	11310 E. US 50 Box 729 67801-0729	620-227-6122 Fax: 620-227-2537

KDOT INTERNET ADDRESS

WWW.KSDOT.ORG/HWYCONT.ASP

III. PROTECTION OF TRAVELING PUBLIC

A. TRAFFIC CONTROL

1. All utility work on the roadway, within the "Clear Zone", or involving equipment parked in the "Clear Zone" requires a Traffic Control Plan. The Clear Zone Table is located in the Appendix.
2. Traffic Control is to be provided by the Utility Company or ROW Occupant for all Highway Permits and Utility Permit Agreements, including all "Standing Permits," whenever such Utility Company work interferes with the movement of traffic or where the work or equipment is located within the Clear Zone.
3. Personnel working on KDOT right-of-way must wear ANSI Class II High Visibility Safety apparel compliant with 23 CFR Part 634, as set forth in 71 Federal Register 67792 to 67800 (Nov. 24, 2006). The purpose of the regulations is to decrease the likelihood of worker fatalities or injuries caused by motor vehicles and construction vehicles and equipment within the right-of-way.
4. The traveling public shall be warned of the activities of the contractor or individuals involved with utility construction and maintenance within the highway right-of-way by means of signs, flaggers, and traffic control devices as outlined in the latest edition of the "Manual of Uniform Traffic Control Devices" (MUTCD), U.S. Department of Transportation, FHWA, or the State of Kansas Traffic Control Standards. Whenever the Traffic Control Standards conflict with the Manual, the Standards shall govern.
5. Flaggers will be required according to the MUTCD when utility construction and maintenance work on the roadway (includes pavement) is in progress. Control by flaggers is for the safety of the workers and the traveling public. Flaggers must wear ANSI Class II safety vests and high visibility headwear at all times when flagging traffic. Utilities can obtain the 'State of Kansas Traffic Control Handbook for Flaggers' from any KDOT Office or download from www.ksdot.org.
6. Typical Signing Plans for traffic control on highways involving "Roadside Work" and "Lane Closure" are included in the Appendix. These are typical plans and should be supplemented if necessary to conform to the MUTCD or the State of Kansas Highway Traffic Control Standards. When ever the Traffic Control Standards conflict with the Manual, the Standards shall govern.
7. A specific Traffic Control Plan may be required for utility work on Divided, Four-Lane Undivided, and High Volume Two-Lane Highways, especially in Metropolitan Areas.

8. All Traffic Control Plans must be preapproved by the District Engineer or designee.

B. STORAGE AND PARKING

Storage of materials, parking of equipment and vehicles when not used in actual utility work within the Interstate, Freeway, or Highway Right-of-Way will not be permitted on the right-of-way unless no other alternative is available. If such storage or parking is permitted, then it must be located beyond the Clear Zone and as far to the edge of the right-of-way as possible.

IV. DESIGN CONSIDERATIONS

A. DESIGN

Each Utility Company is responsible for the design of their facilities to be installed within the highway right-of-way or attached to a highway structure.

B. MATERIALS

All Utility Company installations along, crossing over or under highway right-of-way and attachments to highway structures shall be of durable materials designed for long service life expectancy and free from routine servicing and maintenance. Materials shall conform with current applicable material specifications and codes.

C. FUTURE EXPANSION

1. On new installations or adjustments of existing Utility Company lines, provision should be made for known or planned expansion of the Utility Company facilities, particularly those located underground or attached to bridges and structures.
2. Plan future expansion to minimize hazards and interference with highway traffic when additional overhead or underground lines are installed.

D. CATHODICALLY PROTECTED UTILITIES

Buried pipelines cathodically protected must be electrically isolated from underground metallic highway structures, unless the pipeline and highway structure are interconnected and cathodically protected as a single unit. Any cathodically protected utility shall be at least 10 feet (3.05 meters) from any bridge substructure. Anode beds associated with a cathodically protected utility shall be at least 300 feet (92 meters) or more from any substructure element. Inspections and electrical tests must be made to assure proper electrical isolation. Pipeline cathodic protection systems shall be designed as to minimize any adverse impacts of stray currents to adjacent structures.

V. MAINTENANCE AND SERVICING OF UTILITIES

A. UTILITY COMPANY'S RESPONSIBILITY

1. Maintenance of the utility is the responsibility of the Utility Company.
2. Maintenance must be performed to keep the utility in an as constructed condition and in compliance with the requirements of Federal, State and local statutes, regulations and utility codes.
3. Utility Companies shall replace and stabilize all earth cover and vegetation where the underground utility has caused erosion.
4. The Utility Company shall repair settlement of backfills, fills, and embankments placed by the Utility Company or its contractors or subcontractor at any tier which may occur within one year of notice of acceptance from the District Engineer or designee. Any repairs shall be made by the Utility Company within thirty (30) days after receipt of notice from the District Engineer or designee, such receipt evidenced by KDOT placing notice in the U.S. Mail.

B. EMERGENCY REPAIR

1. Emergency repair of utilities located on highway right-of-way, including Interstate and other Fully Controlled Access Highway right-of-way, is permissible without first obtaining a Highway Permit, if an emergency exists that is dangerous to the life, safety or welfare of the traveling public and requires immediate repair. The Utility Company shall take all reasonable safety measures and temporary traffic control measures consistent with the (MUTCD) or the State of Kansas Traffic Control Standards, to protect the traveling public during repairs and cooperate fully with the State Highway Patrol and KDOT.
2. The Utility Company will advise the Area and District office of the location as soon as possible but no later than 24 hours after discovering the emergency. The Utility Company will coordinate with KDOT on the work and traffic control. Any damage to the right-of-way will be restored in accordance with Section VII - A, "Disturbed Areas." A Highway Permit should be requested by the Utility Company within the second working day after the emergency, unless the work is covered under the "Standing Permit".

VI. ROADSIDE LANDSCAPE AND SCENIC ENHANCEMENT

A. SCENIC AREAS

Areas that have been acquired or set aside for their scenic qualities require specific controls of the type and size of Utility Company facilities. Permits will be reviewed on an individual basis. New Utility Company installations in the following areas including those for highway use must be approved by the FHWA where Federal-Aid projects are involved.

- Scenic strips
- Overlooks
- Rest areas
- Recreation areas
- Right-of-way sections of highways that pass through public parks and historical sites.

B. VISUAL CONTROLS

1. New underground installations may be permitted within scenic areas where no extensive removal or alteration of trees or other natural features is visible to the highway user and where the installation does not impair the visual quality of the lands being traversed.
2. New aerial installations shall be avoided in areas where there is a feasible and prudent alternative. Factors to be considered include but are not limited to:
 - a. Other locations are unusually difficult and unreasonably costly or are more desirable from the standpoint of visual quality;
 - b. Underground installation is not technically feasible or is unreasonably costly;
 - c. The proposed installation can be made at a location and will employ suitable designs and materials which give adequate attention to the visual qualities of the area being traversed.
3. These controls shall also apply to the location and design of Utility Company installations that serve highway purposes. Such highway purpose include, but are not limited to, continuous highway lighting, weigh stations, rest stops and recreation areas.

C. PROTECTION OF VEGETATION

Consistent with the preservation of planted vegetation, consideration will be given to Utility Company for the necessary trimming, clearing or removal of vegetation to provide adequate clearance of overhead wires. Such work will be done in accordance with established practices and standards outlined in the KDOT "Highway Maintenance Manual". Approval shall not be granted for wasteful or wanton trimming or removal .

VII. PRESERVATION, RESTORATION, AND CLEANUP

A. DISTURBED AREAS

1. Areas of highway right-of-way disturbed by the installation, maintenance, removal and relocation of utilities shall be kept to a minimum with special care taken to avoid disturbing existing drainage facilities.
2. All excavations will be backfilled within forty-eight (48) hours after work is completed, or as directed by the District Engineer or designee, and shall comply with KDOT "Standard Specifications for State Road and Bridge Construction". When required, adequate traffic control will be provided as outlined in Section III - A, "Traffic Control".
3. Disturbed areas shall be returned to normal grade and elevation with adequate compaction of backfill material and all excess or undesirable material removed by the Utility Company. All destroyed vegetation shall be replaced by the Utility Company by sodding, seeding, fertilizing or mulching as required by the District Engineer or designee in conformity with KDOT "Standard Specifications for State Road and Bridge Construction."
4. Adequate protection against erosion shall be provided by the Utility Company in disturbed areas that are susceptible to erosion. Such protection may be in the form of rock rip-rap, wash checks, hay cover or other material that does not interfere with highway maintenance operations and is approved by the District Engineer or designee.
5. Disturbed or broken Right-of-Way markers shall be reestablished by a licensed Land Surveyor.

B. DRAINAGE FACILITIES

Utility Company shall not disturb existing drainage facilities. Underground utility facilities shall be back-filled with pervious material and outlets provided for entrapped water. Underdrains shall be provided where necessary.

C. CLEANUP

Prior to the final inspection for acceptance of work performed on highway right-of-way, the Utility Company shall restore all "Disturbed Areas" as required under Subsection A of this Section, remove all unused material or debris from the work area, and leave the right-of-way in a clean, acceptable condition.

VIII. SPRAYING, CUTTING AND TRIMMING TREES

A. PERMIT REQUIRED

Trees, shrubs, bushes, vines or ground cover on the highway right-of-way shall not be sprayed, trimmed, cut down, rooted up, removed, or mutilated in any manner, unless a Highway Permit (D.O.T. Form No. 304) or Highway Permit Harvesting Hay on Highway Right-of-Way (D.O.T. Form No. 317) is granted.

B. CHEMICAL BRUSH CONTROL

Spraying brush and seedling tree growth by Utility Companies or ROW Occupant is prohibited unless a permit is granted by the District Engineer or designee. Such activities shall be performed with extreme caution. The Utility Company or ROW Occupant shall be responsible for the performance of their employees, agents, contractors or subcontractors at any tier in the application of chemicals for brush control.

1. All spraying shall be done by a licensed herbicide applicator, licensed under Category Six of K.S.A. 2-2444a and approved by the Kansas Department of Agriculture.
2. Liability insurance, including coverage for chemical application damage, shall be provided in accordance with the Highway Permit (D.O.T. Form No. 304) prior to issuing a Highway Permit for the use of chemicals.
3. Work involved on each permit application must be reviewed in detail and approved in writing by the District Engineer or designee prior to issuing the permit.
4. The name and type of chemical weed and brush killers that will be used on state highway property shall be listed on the permit application.
5. Plants over five feet (1.5 meters) in height shall not be sprayed. Remove brush over five feet (1.5 meters) in height. Stumps shall be cut flush or below ground level and treated to prevent regrowth.
6. Shrubbery-type growth such as dogwood, sumac, redbud, plum, etc., shall not be sprayed unless prior approval is received in writing from the District Engineer or designee.

7. Steep slopes where brushy growth is a major factor in preventing erosion shall not be sprayed without prior written approval of the District Engineer or designee.
8. The spraying program shall be arranged, if possible, so that long stretches of right-of-way or both sides of the highway are not treated at one time.

C. TREE PRUNING

Tree pruning on highway right-of-way for utility lines will utilize best horticulture practices and shall be done in accordance with the KDOT "Highway Maintenance Manual" www.ksdot.org.

1. The pruning, trimming or removal of trees for utility line clearance or other purposes requires the authorization in writing from the District Engineer or designee.
2. Any and all limbs trimmed shall be removed with a clean cut as set forth in the Highway Maintenance Manual, Section 4.30 Landscape.
3. All cut branches, dead limbs, etc., shall be removed from Clear Zone while traffic control is in place and cleared from the highway right-of-way within forty-eight (48) hours or as directed by the District Engineer or designee. Such materials shall not be burned along the roadside unless such permission is granted on the permit and all required permits for open burning have been obtained by the Utility Company or ROW Occupant.
4. The Utility Company or ROW Occupant shall be held liable for any damage to grass, crops, native shrubs or trees arising from open burning of brush.
5. The Utility Company or ROW Occupant shall secure all required permits for open burning.

IX. SPECIAL USES FOR HIGHWAY PERMITS

Below is a list of special uses for Highway Permits and reference to applicable policies:

A. BANNERS

Refer to Highway Maintenance Manual Chapter 11.25

B. CATTLE CROSSING

Refer to Highway Maintenance Manual Chapter 11.25

C. FENCING

Refer to Appendix for the Kansas Department of Transportation Highway Fencing Policy

- D. FLOWER PLANTING AND LANDSCAPING**
Refer to Highway Maintenance Manual Chapter 11.25
- E. FOSSIL AND ROCK HUNTING**
Refer to Highway Maintenance Manual Chapter 11.25
- F. GRAIN STORAGE ON MIXING STRIPS AND OTHER KDOT PROPERTY**
Refer to Highway Maintenance Manual Chapter 11.25
- G. MAIL BOX INSTALLATION**
KDOT has adopted the Mail Box Installation guidance from the AASHTO Roadside Design Guide. Refer to Appendix for a summary of the guidance.
- H. PAY PHONES AT REST AREAS**
Refer to Highway Maintenance Manual Chapter 11.25
- I. SURVEYORS**
Refer to Appendix for the Standing Permit Policy for Land Surveyors working within the State Highway System Right-of-Way.
- J. WELCOME SIGNS, CITY OWNED**
Refer to Appendix for KDOT policy on City Owned Welcome signs with in the State Highway System Right-of-Way.
The City will also need complete a D.O.T. Form No. 1952 and submit the appropriate fee to the Bureau of Right of Way, pursuant to the K.S.A 68-2236

(This Page Intentionally Left Blank)

PART TWO



UTILITIES ON PERMITTED HIGHWAYS



**PART TWO
UTILITIES ON PERMITTED HIGHWAYS**

	PAGE
I. GENERAL PROVISIONS	2-1
A. LOCATION.....	2-1
B. TRENCHING AND BACKFILL	2-2
C. PIPELINE INSTALLATIONS	2-3
D. MONITORING AND REMEDIATION WELLS.....	2-3
II. ABOVEGROUND INSTALLATIONS	2-4
A. GENERAL	2-4
III. UNDERGROUND INSTALLATIONS.....	2-6
A. GENERAL	2-6
B. UNDERGROUND INSTALLATIONS CROSSING THE ROW	2-8
IV. ENCASEMENT OF UTILITIES	2-9
A. GENERAL	2-9
B. CASING REQUIREMENTS FOR UTILITIES CROSSING ROW	2-9
C. BORING.....	2-11
D. CASING MATERIAL	2-12

PART TWO

UTILITIES ON PERMITTED HIGHWAYS

I. GENERAL PROVISIONS

This Part of the Policy applies to all public and private utilities, including electric power, telephone, telegraph, cable television, water, gas, oil, petroleum products, steam, chemicals, sewage, drainage, irrigation, and similar lines that are to be located, adjusted, or relocated, within the right-of-way under the jurisdiction of the Secretary, except Fully Controlled Access Highways covered in Part Three. Such utilities may involve underground, surface, or aboveground facilities, either singly or in combination.

Expressway type highways with Partial Control of Access which do not meet all criteria to qualify as Fully Controlled Access Highways, at the discretion of the District Engineer or designee, may be required to follow requirements of this Policy as outlined in Part Three - "Utility Accommodation Policy for Fully Controlled Access Highways."

Part One - "General Policy" and Part Four - "Attachments to Bridges and Structures or Installations near Retaining Wall Systems" contain general information and other requirements which pertain to Part Two and are to be referred to in application of this Policy.

Utility Company lines constructed on public highway right-of-way shall be in conformance with the current "National Electrical Safety Code", "American Waterworks Association Specifications", "Federal Pipeline Safety Regulations" and KDOT "Standard Specifications for State Road and Bridge Construction". Utilities must be located beyond the clear zone.

A. LOCATION

1. Utility Company installations shall be located to minimize need for later adjustment to accommodate future highway improvements and to permit servicing such lines with minimum interference to highway traffic and highway maintenance operations.
2. All Utility Company installations, adjustments, and/or relocations, shall be located with consideration to highway and Utility Company costs, impacts on highway users, interference with highway facilities and their operation, and impacts on highway maintenance operations.
3. Parallel installations shall be located on uniform alignment within seven feet (2.1 meters) or less of the right-of-way line to reduce impacts on traffic operations and preserve space for future highway improvements or other transportation purposes.

4. Utility Company line crossings of highway right-of-way are to be installed perpendicular to the highway alignment to the extent possible.
5. The horizontal and vertical location of Utility Company lines within the highway right-of-way is to conform to the dimensions outlined in Sections II and III of this Part.
6. Attachments to bridges and structures must be in accordance with this Policy outlined in Part Four - "Attachments to Bridges and Other Structures or Installations near Retaining Wall Systems".

B. TRENCHING AND BACKFILL

1. Where soil and depth conditions permit, trenches should be cut to have vertical faces with a maximum width of outside diameter of pipe plus two feet (600 millimeters). Trenches must be shored where necessary for safety and to protect the traveled way, shoulders and slopes.
 - a. Bedding shall be provided to a depth of six inches (150 millimeters) or half of the diameter of the pipe, whichever is less. This requirement may be waived for lines with inside diameter of two inches (50 millimeters) or less, and installed in compliance with the American Waterworks Association (AWWA) standards, or other applicable Industry Standards.
 - b. Bedding material shall be free of lumps, clods, stones, and frozen material and shall be graded to a firm but yielding surface without abrupt changes in bearing value.
2. Backfilling of open trenches shall use only approved materials that will produce a dense, well-compacted backfill. Materials containing frozen soil, sod, debris, or organic material shall not be used.
 - a. The materials shall be placed in uniform layers not to exceed eight inches (200 millimeters) in depth and compacted by means of suitable equipment or by tamping with mechanical or hand tampers.
 - b. The moisture content of the soil used for backfilling shall be uniform and shall be such that required densities can be obtained.
3. A blasting plan shall be submitted to the District Engineer or designee before blasting a trench for utilities in rock on the right-of-way. A blasting plan will also be reviewed by KDOT Bridge Design before blasting a trench for utilities in rock on the right-of-way within 100 feet (30.5 meters) of a bridge or highway structure.

C. PIPELINE INSTALLATIONS

1. Utility Companies shall specify the type and class of material, test, design and maximum working pressures of their pipeline installations. Utility Companies operating pipelines that are not constructed, operated, and maintained under regulations established by the U.S. Department of Transportation shall upon revision in the class of material or an increase in the maximum operating pressure, advise the Secretary of Transportation in writing of such revisions.
2. Vents are appurtenances by which fluids between carrier and casing may be inspected, sampled, exhausted, or evacuated.
 - a. Vents shall be located at the high end of short casings and at both ends of casing longer than 150 feet (45 meters).
 - b. Vent standpipes shall be located and constructed so as not to interfere with maintenance of the highway nor to be concealed by vegetation. Where possible, they shall be marked and located at the right-of-way line. The markers shall display the name and telephone number of company officials to contact in case of emergency.
3. Drains are appurtenances by which liquids or heavy gases may be evacuated or exhausted.
 - a. Roadside ditches or natural water courses shall not be used for purging the carrier unless specifically authorized by the Secretary and any state or federal agency with jurisdiction over said ditches or water courses.
4. The Utility Company shall place readily identifiable and suitable markers at the right-of-way where it crosses the highway except in those cases where a vent serves as a marker.

D. MONITORING AND REMEDIATION WELLS

All efforts to place monitoring or remediation well(s) off of KDOT ROW shall be thoroughly evaluated by the applicant prior to installation on KDOT ROW.

1. Monitoring and Remediation Wells shall be located outside of the highway Clear Zone. Wells shall not be located in the toe of the slope.
2. The District Engineer or designee will decide if Monitoring or Remediation Wells shall be installed flush with the ground or raised and such requirement shall be stated on the permit. Monitoring or Remediation Wells will be installed in accordance with current Kansas Department of Health Environment (KDHE) standards. Ground markers are to be located at the outer limits of the right-of-way line.

3. During maintenance/construction activities, the ROW Occupant will locate and mark wells as needed.
4. During installation and monitoring, the ROW Occupant shall use approved traffic control procedures consistent with the MUTCD or the State of Kansas Traffic Control Standards. Whenever the Traffic Control Standards conflict with the Manual, the Standards shall govern.
5. During well sampling, installation or closure, the ROW Occupant should park vehicles on the right-of-way beyond the clear zone.
6. Monitoring and Remediation Wells shall be installed consistent with the KDHE and KDOT Memorandum of Understanding dated August 4, 1995, referenced in the appendix.

II. ABOVEGROUND INSTALLATIONS

Where a utility crosses over or under a Fully Controlled Access Highway, the utility is to be serviced without access from the roadway or ramps. Aboveground utilities crossing the right-of-way shall be perpendicular to the highway alignment to the extent feasible and practicable. Complete spanning of access controlled right-of-way is encouraged with supportive structures and appurtenances located outside the right-of-way lines. When spanning is not feasible, consideration should be given to underground installation.

A. GENERAL

1. Aboveground Utility Company installations in rural areas are to be located at the outer limits of the right-of-way, preferably within two feet (600 millimeters) or less of the right-of-way line. As a minimum when considering specific installations, facilities shall not be allowed closer to the traveled way than the Clear Zone. As a general guide the Clear Zone distance may be determined from the Clear Zone Table in the Appendix. This table is adopted from the AASHTO publication, "Roadside Design Guide" current addition.
2. In suburban areas, with rural type highways and posted speeds of 45 mph (70 km/h) or lower, Utility Company poles or appurtenance are to be located at least 15 feet (4.5 meters) from the edge of the traveled way, with the preferred location near the right-of-way line.
3. In urban areas, where there are curbed sections, the utilities should be located at least six feet (1.8 meters) from the back of the curb; eight feet (2.4 meters) is desirable. Exceptions will be considered only in extreme cases. The preferred location is near the right-of-way line. When the above distances are not practicable, exceptions will be considered with consideration given to protection devices or break-away supports.

4. At interchange areas, aboveground installations and appurtenances are to be located near the right-of-way line, but in no case closer than the Clear Zone.
5. Poles, guys, anchors, or other appurtenances shall not be located in the travel way, shoulder slopes, ditches, backslopes, medians, at drainage structure openings, or on roadway shoulders. Exceptions may be permitted with the approval of the District Engineer or designee, but generally facilities should not be allowed closer to the paved traveled way than the Clear Zone. The “Clear Zone Table” is located in the Appendix. All poles, guys, anchors, or other appurtenances shall be located to minimize interference with maintenance operations of KDOT. Support structures and appurtenances may be allowed in medians greater than 100 feet (30.5 meters) in width when crossing the right-of-way.
6. Service lines (those that run from the primary lines on KDOT right-of-way to a house or business) should utilize a “Slack” line configuration. The “Slack” line configuration will eliminate the need for additional guy anchors extending on to the right-of-way and congesting the utility corridor.
7. The minimum vertical clearance to overhead installations including guy wires and telephone poles should be that required by the National Electrical Safety Code, Institute of Electrical and Electronics Engineers, Inc. However, additional clearance may be required by the KDOT in certain instances.

General clearance guides are provided as follows:

<u>Vertical Clearance</u>	<u>Line Voltage</u>
18 feet (5.5 meters)	Any Communication Line
18 feet (5.5 meters)	0-750
20 feet (6.1 meters)	750-22,000
**	22,000-470,000
***	Over 50,000

** Increase general clearance 0.4 inch (10 millimeters) for each 1,000 volts of the excess over 22,000 volts.

*** All clearances for lines over 50,000 volts shall be based on maximum operating voltage. For voltages exceeding 50,000 volts, the additional clearance specified shall be increased 3% for each 1,000 feet (300 meters) in excess of 3,300 feet (1,000 meters) above mean sea level.

8. Installations should be limited to single pole type construction with vertical configuration of conductors and cables. Joint-use single pole construction is encouraged at locations where more than one utility or type of facility is involved.

III. UNDERGROUND INSTALLATIONS

A. GENERAL

1. Underground utility installations should be located within the seven feet (2.1 meters) utility corridor at the right-of-way line. All installations and appurtenances shall be located to minimize interference with maintenance operations of KDOT and other utilities in the corridor.
 - a. All Utility Company appurtenances above the ground surface shall be located outside the Clear Zone in the seven feet (2.1 meters) utility corridor at the right-of-way line.
2. Utilities will not be permitted in the traveled way, median shoulder, shoulder slope, ditch, or back slope, exception will be considered in extreme cases and require written approved by the District Engineer or designee.
3. Utility Companies petitioning to place utilities near a Retaining Wall System, within a distance of 2 times the height measured from the back face of the wall system or one times the height in front of the wall, shall complete the form Attachment to Bridges and Other Structures or Installations near Retaining Wall Systems (D.O.T. Form No. 310), See Chapter 4, Attachments to Bridges and Other Structures or Installations near Retaining Wall Systems.
4. Underground facilities shall be installed at a minimum depth of three (3) feet (900 millimeters). Such cable may require greater burial depth at certain locations including, but not limited to, crossings of streambeds, side roads, and major entrances. In no case shall the depth of cover for any underground facilities be less than that meeting applicable Industry Safety Guidelines.
 - a. If less than minimum depth is necessary because of existing utilities, water table, ordinance, or similar reasons the line shall be rerouted or protected with a casing, suitable bridging, concrete slab or other appropriate means.
 - b. Locations where it will be difficult to attain minimum depth due to wet or rocky terrain shall be avoided. Any plan location change must be approved by the District Engineer or designee.
5. Manholes shall not be located in a bridge deck, traveled way, median, shoulder, shoulder slope, ditch or backslope and shall not protrude above the surrounding ground.

6. Any above ground structures (i.e. pedestal) shall be marked by a post higher than the surrounding vegetation. This post shall be a minimum of six feet (1.8 meters). All pedestal type structures shall be located at the outer limits of the right-of-way, preferably within two feet (600 millimeters) or less of the right-of-way line.
7. Buried electrical lines paralleling the right-of-way will only be allowed where KDOT determines there is no reasonable alternative.
 - a. The electrical line shall be buried a minimum depth of 48 inches (1.2 meters) unless it is encased.
 - b. A tape shall be placed 12 inches (300 millimeters) below grade to mark the location of the cable.
 - c. Whenever the electrical line crosses a roadway, it shall be cased; this includes side roads as well as state highways.
 - d. Electrical lines crossing state highways shall be marked with an aboveground marker on each side of the right-of-way.
 - e. The Utility Company shall mark buried cable with above ground markers a minimum of four times per mile (kilometer). These markers may be placed directly above the buried cable, or offset at the right-of-way line at the discretion of the District Engineer or designee.
 - f. KDOT may also require the encasement of the electrical line whenever it is in close proximity of a sign, i.e. stop sign, for the safety of KDOT personnel when replacing downed signs.
8. Utility Company lines installed parallel to highway right-of-way require casing at certain locations. Such locations include, but are not limited to, crossings of side roads and major entrances.
9. All buried plastic pipes shall be required to have a trace wire for ease of locating.
10. Private and public Utility Company lines shall not be permitted to be attached to or routed through drainage structures or cattle passes.
11. Fiber optic lines shall be buried at a depth of 42 inches (1.01 meters) and have a trace wire for ease of locating.
12. Buried vaults larger than a hand hole (3 foot x 4 foot) shall be located on private right-of-way. Aboveground equipment cabinets other than splitter posts shall be located on private right-of-way.

13. Point of Presents (POP) Buildings are to be approved by the District Engineer or designee. POP buildings typically are located at interchanges. POP buildings shall be located beyond the Clear Zone and shall not interfere with the line of sight geometrics of the interchange.

B. UNDERGROUND INSTALLATIONS CROSSING RIGHT-OF-WAY

1. All utilities crossing under ditches and roadways should have a minimum depth of cover of five feet (1.5 meters) below crown grade or three feet (900 millimeters) below ditch grade (original plan grade elevation), whichever shall govern. In fill sections, the natural ground line at the toe of the slope will be considered as ditch grade. However, in no case shall the depth of cover be less than that meeting applicable Industry Safety Guidelines.
 - a. If the minimum depth is not possible because of existing utilities, water table, ordinances, or similar reasons, the line shall be rerouted or protected with a casing, suitable bridging, concrete slab or other appropriate means.
 - b. Locations that are considered unsuitable or undesirable shall be avoided. These include, but are not limited to, locations as in deep cuts, near bridge footings, and in wet or rocky terrain where it is difficult to obtain minimum depth. Plan location changes must be approved by the District Engineer or designee.
2. Underground installations may be made by open trenching from the right-of-way line to the toe of the fill slope in fill sections and to the toe of the shoulder slope in cut sections. No trenching or excavating shall be allowed in the fill or shoulder slope unless approved by the District Engineer or designee. The remainder will be tunneled, augured, or dry bored through the roadway and shall be cased, unless casing is waived by the District Engineer or designee.

IV. ENCASEMENT OF UTILITIES

A. GENERAL

1. Casings are oversized load bearing conduits or ducts through which a utility is inserted:
 - a. To protect the roadway from damages and to provide for repair, removal and replacement of the utility without interference to highway traffic.
 - b. To protect the carrier pipe from external loads or shock, either during or after construction of the highway.
 - c. To convey leaking fluids or gases away from the area directly beneath the traveled way to a point of venting at or near the right-of-way line.
2. The casing shall include necessary appurtenances, such as vents, drains, and markers. Casing pipe shall be sealed at both ends with a suitable material to prevent water or debris from entering the annular space between the casing and the carrier, in accordance with Pipeline Industry Standards.
3. Utility Company lines crossing highway right-of-way shall be cased from right-of-way line to right-of-way line. The District Engineer or designee may allow minimum encasing from toe of backslope to toe of backslope in ditch sections and from toe of fill slope to toe of fill slope in fill sections.
4. Utility Company lines installed parallel to highway right-of-way require casing at certain locations. Locations included, but not limited to, are the crossings of side roads and major entrances.

B. CASING REQUIREMENTS FOR UTILITIES CROSSING THE RIGHT-OF-WAY

1. Underground electric service lines shall be placed in conduit or ducts from right-of-way line to right-of-way line and shall be clearly marked by the Utility Company at the outer limits of the right-of-way.
2. Underground fiber optic lines shall be placed in schedule 40 PVC, HDPE, or equivalent from right-of-way to right-of-way line, with a tracer wire and must be clearly marked by the Utility Company at the limits of the right-of-way.
3. Direct buried telephone and communications cable will not be required to be cased.

4. Lines carrying high-pressure natural gas, liquid petroleum products, ammonia, chlorine, or other hazardous or corrosive products need not be cased provided they are:
 - a. Welded steel pipelines;
 - b. Cathodically protected, if welded steel;
 - c. Coated in accordance with accepted Industry Standards, if welded steel;
 - d. Wall thickness is thick enough to meet requirements of the Federal Pipeline Safety Regulations - Code of Federal Regulations - Title 49 Code of Federal Regulations Parts 191 and 192 (Natural Gas) or Part 195 (Liquid Petroleum Gas) with respect to wall thickness;
 - e. Designed for operating stress levels in accordance with Federal Pipeline Safety Regulations;
 - f. Natural gas distribution and service lines with maximum pressure of sixty pounds per square inch (PSI) [414 Kpa] of copper, steel or plastic which have an inside diameter of two inches (50 millimeters) or less.
5. When a waiver of casing is requested, the Utility Company shall provide, as a part of the Permit, a statement of certification that Utility Company pipeline will comply with the applicable conditions and provisions contained in items (a) through (f) in Section B.5. above. D.O.T. Form No. 308, 'Cased Utility Line Waiver', located in the Appendix shall be used.
6. Gas pipelines not meeting applicable conditions and provisions (a) through (f) in Section B.5. above shall be cased within the right-of-way limits and shall be vented and marked at the outer right-of-way limits. The markers shall give the name of the owner and phone number to contact in case of an emergency.
7. Sanitary sewer lines crossing the right-of-way must be encased from right-of-way line to right-of-way line. An exception shall be made for gravity flow lines placed prior to highway construction, properly bedded, and constructed of heavy duty cast or ductile iron pipe with suitable mechanical and/or restraint joints and seals. Suitability shall be determined by the District Engineer or designee in writing.

8. Water lines must be cased, from toe to toe of backslope in ditch sections or toe to toe of fill slope in fill sections. Venting and sealing of casement is not required. Casement is not required provided:
 - a. Water line is placed prior to highway construction utilizing extra strength cast iron or ductile iron with mechanical and/or restraint joints and seals, and is properly bedded. The extra strength pipe is to be used from right-of-way line to right-of-way line.
 - b. Any copper, steel, or plastic waterline has an inside diameter of two inches (50 millimeters) or less.
9. All plastic pipe with inside diameter greater than two inches (50 millimeters) must be cased from right-of-way line to right-of-way line and meet minimum ASTM specifications and all applicable laws and codes. In certain instances as determined appropriate by KDOT in writing, minimum casing may be allowed requiring encasing from toe of backslope to toe of backslope in ditch sections and from toe of fill slope to toe of fill slope in fill sections.
10. Uncased Utility Company installations, which by reason of shallow depth or location make them vulnerable to damage from highway construction or maintenance operations, shall be protected with suitable bridging, concrete slabs or other appropriate measures.
11. Underground utility installations not listed below may be installed without protective casing, where it is acceptable to both the Utility Company and KDOT. Any such determination by KDOT shall be in writing. Approval will be determined by the District Engineer or designee on an individual basis and limited to:
 - a. Open trenched construction;
 - b. Small bores;
 - c. Pipelines that are continuous (seamless) without joints;
 - d. Gas lines designed using the National Gas Institute Guidelines for Pipelines Crossing Railroads and Highway. A computer printout must be submitted showing that the crossing is designed without encasement to meet stresses at the highway crossing.

C. BORING

1. Pits for ~~borings, tunneling or jacking~~ will not be permitted in the highway media in toe of fill in fill sections or right-of-way line. Allowed on the

Revised - Section C. Boring
See Horizontal Directional Drilling - Addendum
September 5, 2018

2. Casing and pipeline installations shall be accomplished by dry boring, tunneling, jacking, trenching, or other approved methods.
 - a. The use of water under pressure (jetting) or puddling will not be permitted to facilitate boring, pushing, or jacking operations. Some boring may require water to lubricate cutter and pipe and under Revised - Section C. Boring
See Horizontal Directional Drilling - Addendum
September 5, 2018 written
 - b. where unstable soil conditions exist, boring or tunneling operations shall be conducted in such a manner as not to be detrimental to the roadside being crossed.
 - c. If excessive voids or a too large bored hole is produced during casing or pipeline installations, or if it is necessary to abandon a bored or tunneled hole, prompt remedial action shall be taken by the Utility Company, subject to the written approval of the District Engineer or designee.
 - d. All voids or abandoned holes caused by boring or jacking are to be filled by pressure grouting when deemed necessary by the District Engineer or designee in writing. The grout material should be a sand cement slurry with a minimum of two sacks of cement per cubic yard and a minimum of water to assure satisfactory placement.
3. The hole diameter resulting from bored or tunneled installations shall not exceed the outside diameter of the utility pipe, cable or casing (including coating) by more than 1.5 inches (40 millimeters) on pipes with an inside diameter of 12 inches (300 millimeters) or less; or two inches (50 millimeters) on pipes with an inside diameter greater than 12 inches (300 millimeters).

D. CASING MATERIAL

The following materials are acceptable for use in the casing of utility facilities when permitted by industry requirements and standards.

1. Welded steel pipe, smooth wall, in sound condition meeting the requirements of the current KDOT "Standard Specifications for State Road and Bridge Construction".
2. Corrugated metal pipe and coupling band meeting the requirements of the current KDOT "Standard Specifications for State Road and Bridge Construction".

3. Reinforced concrete pipe meeting the requirements of the current KDOT "Standard Specifications for State Road and Bridge Construction".
4. Vitrified clay pipe meeting the requirements of the current KDOT "Standard Specifications for State Road and Bridge Construction".
5. Cast iron pipe or ductile iron of the same class as used for carrier pipe, providing it meets the minimum ASTM Specifications. A statement certifying that such specifications are met will be submitted as a part of the permit.
6. Polyvinyl Chloride (PVC) meeting the requirements of the current KDOT "Standard Specifications for State Road and Bridge Construction."

High-Density Polyethylene (HDPE) providing it meets the minimum ASTM Specifications.

Chlorinated Polyvinyl Chloride (CPVC) providing it meets the minimum ASTM Specifications and all applicable laws and codes, in accordance with the listing below:

CPVC - WATER LINE PIPE

ASTM SPECIFICATION
F 441

<u>Casing Diameter</u>	<u>Min. Wall Thickness</u>	<u>Schedule</u>
4 inches (100 mm)	0.237 inches (6.02 mm)	40
6 inches (150 mm)	0.280 inches (7.11 mm)	40
8 inches (200 mm)	0.322 inches (8.18 mm)	40
10 inches (250 mm)	0.365 inches (9.27 mm)	40
12 inches (300 mm)	0.460 inches (10.31 mm)	40

The use of PVC pipe for casing is acceptable up to a maximum diameter of 12 inches (300 millimeters).

7. Electric conduits may be of non-metallic materials such as polyvinyl chloride, high-density polyethylene, transite, or vitrified clay.

(This Page Intentionally Left Blank)

PART THREE



**UTILITY ACCOMMODATION POLICY
FOR FULLY CONTROLLED
ACCESS HIGHWAYS**



PART THREE
UTILITY ACCOMMODATION POLICY
FOR FULLY CONTROLLED ACCESS HIGHWAYS

	PAGE
I. STATEMENT OF POLICY	3-1
A. CRITERIA FOR LONGITUDINAL INSTALLATIONS.....	3-1
B. LIABILITY.....	3-2
C. PRINCIPLES.....	3-2
D. GENERAL	3-2
E. LENGTH OF INSTALLATION.....	3-3
II. INSTALLATION AND MAINTENANCE GUIDELINES	3-3
A. UTILITY REQUIREMENTS	3-3
B. THE SECRETARY'S AUTHORITIES AND RESPONSIBILITIES	3-5
III. UTILITY PERMIT AGREEMENT	3-7
A. APPLICATION PROCEDURE.....	3-7

PART THREE

UTILITY ACCOMMODATION POLICY FOR FULLY CONTROLLED ACCESS HIGHWAYS

I. STATEMENT OF POLICY

This policy is established pursuant to 23 U.S.C. 109 and 23 U.S.C. 111 and Federal Regulations promulgated there under, 2005 AASHTO Policy on Accommodation of Utilities within Highway Right-of-Way and 2005 Policy of the AASHTO Policy on Accommodations on Utilities within Freeway Right-of-Way prohibiting the longitudinal installation of Utilities along Full Control Access Highways except when a determination is made that would result in severe hardship or is contrary to the public interest.

It shall be the policy of the Secretary, to permit certain Utilities to locate longitudinally within the access control limits of Fully Controlled Access Highways when approved conditions are met.

Utilities that must cross over or under Fully Controlled Access Highways will be regulated in accordance with applicable Sections of Part Two "Utilities on Permitted Highways" of this Policy.

A. CRITERIA FOR LONGITUDINAL INSTALLATIONS

The Secretary may permit longitudinal installations of certain Utilities within the access control limits if the installation meets each of the following conditions:

1. The utility is underground;
2. No aboveground support utilities are within the access control limits, unless such utilities can be located at interchanges or highway Rest Areas;
3. Temporary access for construction by the Utility Company should be accomplished without using through traffic roadways or connecting ramps, and shall have no impact on the health, safety and welfare of the public. (Exceptions as noted in Part Three, Section II.A.10 and II.B.4);
4. The utility would not be used for transmitting gasses or liquids under pressure or for the transmissions of products that are flammable, corrosive, expansive, energized or unstable;
5. The utility shall present no hazard to life, health or property if it fails to function properly, is severed or otherwise damaged;
6. Utility will require minimum maintenance after installation;

7. The maintenance, use or future expansion of the highway will not be impaired and any costs to relocate Utility Company facilities will be born by the Utility Company;
8. Such use by the Utility Company will not restrict or exclude competitors or others who meet these conditions from equitable treatment;
9. The proposed use qualifies as a Categorical Exclusion under the Federal Highway Administration regulations for implementing the National Environmental Policy Act; and
10. The proposed installation meets a need for the KDOT Intelligent Transportation System.

B. LIABILITY

This policy does not confer any liability upon the Secretary for any future costs of damages to or relocation or removal of the Utility Company from the right-of-way for any reason.

C. PRINCIPLES

The underlying principles of this part of the policy are as follows:

1. Economic benefits realized can be passed directly to the general public as users of transportation and Utility Company facilities.
2. Public benefits may accrue if undisturbed land is preserved through joint use of the right-of-way corridors.
3. By being the most direct route with favorable grade and alignment, these corridors provide the most economic transmission route.
4. Protected access of these corridors offers more security to utility lifelines from accidental or malicious damage.

D. GENERAL

1. All Utility Company accommodations other than longitudinal on Fully Controlled Access Highways shall be in accordance with other Parts of this Utility Accommodation Policy.
2. Utility attachments to bridge structures on Fully Controlled Access right-of-way is prohibited except when adverse economic impacts are documented and approval is granted in writing by the Secretary.

3. For partial access control, see Part Two, Section I of this Utility Accommodation Policy.
4. This Policy does not apply to existing Utility Company installations, except when there is a major replacement of current Utility Company facilities.

E. LENGTH OF INSTALLATION

The minimum installation length in rural areas is twenty-five miles and shall be limited in urban areas to facilities which do not start and terminate within the same urbanized area. Exceptions will be considered on a case by case basis.

II. INSTALLATION AND MAINTENANCE GUIDELINES

A. UTILITY REQUIREMENTS

1. The Secretary shall establish a utility corridor along the outer edge of the right-of-way line and a utility access control line between the utility corridor and the roadway and ramps. The Secretary shall only establish a utility corridor on one side of the right-of-way. Where feasible, the utility shall place its facility within this corridor and conduct installation within this area.
2. Limited maintenance will be permitted on the underground facility from within the utility corridor.
3. The Utility Company's installation plan shall take into account:
 - a. Planned or likely improvements or alterations in the nature or configuration of the highway. In planning new or altered uses of the highway, the Secretary will undertake to notify interested Utilities of plans to permit those Utilities to plan their use of highways in a manner which will fulfill the purposes of this policy and make maximum effective use of the highway right-of-way.
 - b. Planned or likely improvements or alterations in the nature and configuration of the Utility Company system.
 - c. Planned or likely use of the utility corridor by other Utility Companies or private users whose installations may also qualify under this policy.
4. Permanent aboveground facilities shall not be placed within the access control of the highway facility except for documented hardship conditions as approved by the Secretary in writing or for installations at Rest Areas.

5. No part of the Utility Company's facility shall be placed in the Clear Zone except upon a finding of necessity by the Secretary. Any such approval shall include the means of installation and set forth requirements for policing and other controls necessary to protect highway users.
6. The Utility Company will furnish all materials and labor required for the proposed installation. The Utility Company may install its facility by manual or machine methods. Where feasible, the Utility Company shall plow its installation since this involves a minimum disturbance of the terrain. When it installs ducts, the ducts shall be installed to a depth that permits at least 42 inches (1050 millimeters) of ground cover. All ducts should be dry bored only unless specified otherwise. Upon completion of installation, the Utility Company shall return the disturbed area to its original condition. Backfill shall be compacted to the same condition as the surrounding area and seeded with a seed mix specified by the Secretary. The Utility Company is responsible for correcting any settlement due to the installation of their facilities.
7. When installation is authorized as provided in this Policy, the Utility Company may not remove or prune any trees or brush without written approval of the Secretary. The proposed installation route will be reviewed by the KDOT Landscape Architect and the District Engineer or designee. The Utility Company will be provided with a summary of the environmentally sensitive areas along the route and the Utility Company will design their installation to protect such areas. The Secretary may require that removed trees be replaced with new trees in the vicinity.
8. In the case of fiber optic or other telecommunication uses of the highway right-of-way, the Secretary may require the installation to be placed in underground duct(s), which shall include two ducts in addition to those the Utility Company proposes to utilize. All ducts should be banded together. Ducts will normally utilize PVC or polyethylene materials and have an inside diameter of four inches (100 millimeters). Additional ducts will become the property of the Secretary.
9. The installation of the duct shall include all appurtenances necessary or incidental to the operation of the facility, and shall include manholes or other access points at appropriate spacings to permit pulling of additional cables into the duct system without further excavation.
10. Where the Secretary finds that other means of access are not practicably available and imposes conditions for policing and other controls to protect highway users, the facility may be installed, serviced or maintained by direct access from through roadways or connecting ramps. The Utility Company will address safety aspects and develop a traffic control plan to mitigate safety concerns prior to any action taken.

11. A Traffic Control Plan shall be included as a part of the Utility Company's installation plans and shall address parking of the work crews and storage of materials. This Traffic Control Plan shall be in accordance with the Manual on Uniform Traffic Control Devices or the State of Kansas Traffic Control Standards. Whenever the Traffic Control Standards conflicts with the Manual, the Standards shall govern. No parking or storage of materials shall be allowed on the right-of-way unless no other alternative is available. If storage or parking is permitted, then it shall be located beyond the Clear Zone.
12. The Utility Company shall install permanent markers at appropriate intervals showing the approximate location of its underground facility. Markers shall not interfere with highway operations. The Utility Company shall also maintain records that describe the facility, its location, depth, size and other relevant data, which shall be available to the Secretary and to other interested Utilities. A copy of these records, including As-Built Plans and any subsequent revisions, shall be provided to the Secretary upon request.
13. The Utility Company will comply with Industry Standards for special marking techniques and location standards for their facility, when the Utility Accommodation Policy calls for more stringent procedures, the Policy shall control.
14. The Utility Company shall make no direct service connection to adjacent properties from the installed Utility Company facility, except that the Utility Company line or branch of the Utility Company line may exit the highway right-of-way at any point along the right-of-way, upon approval by the Secretary.
15. The Utility Company shall obtain all approvals for the authorized activities, including necessary environmental and federal regulatory authorizations, if applicable.
16. The Policy shall be implemented through a Utility Permit Agreement. Upon finding that a proposed installation meets the criteria and conditions of this Policy, the Secretary may authorize the execution of a Utility Permit Agreement.

B. THE SECRETARY'S AUTHORITIES AND RESPONSIBILITIES:

1. Longitudinal installation of a Utility Company facility is prohibited except upon a finding of necessity by the Secretary that:
 - a. The installation will not unreasonably affect the safety, design, construction, operation, maintenance or stability of the highway.

- b. There is adequate usable right-of-way available for Utility Company use that is not needed for planned highway expansion.
 - c. The proposed installation will not interfere with the present or future use of the highway.
 - d. Denial of use of highway right-of-way would have an adverse impact on the productivity of agricultural land. This determination shall be made upon the best information available and shall not be construed to reduce or eliminate the Utility Company's responsibilities in the event that the Secretary later determines that the highway facility requires modernization through reconstruction or widening.
2. The Secretary shall evaluate the proposed installation in terms of the criteria and conditions set forth herein. Upon finding that the proposed installation meets these criteria and conditions, the Secretary shall authorize the installation by executing a Joint Use Agreement as herein provided.
3. The Secretary has the authority to establish utility corridors and utility access control corridors within the highway right-of-way. The Secretary may authorize the Utility Company to locate its facility within a utility access corridor or elsewhere within the right-of-way if it is determined that the authorized location will not unreasonably effect highway or traffic safety or otherwise impair the highway or its aesthetic qualities and is permissible under applicable laws or regulations. The Utility Access Control line shall not be more than 30 feet (nine meters) from the normal Highway right-of-way line. Variations may be necessary due to existing field conditions.
4. The Secretary may authorize the Utility Company to install, service or maintain the Utility Company facility by direct access from the roadways or connecting ramps when it is found that other means of access are not practicably available. Prior to any authorization, the Utility Company will be required to address any safety concerns and submit a traffic control plan for approval.
5. At bridge crossings or where unusual terrain, environmental or other conditions warrant, the Secretary may authorize the Utility Company to install a portion of its facility aboveground or at depths or under certain conditions which differ from those specified in this policy, provided it is determined that the installation will not unreasonably impair highway safety or the aesthetic quality of the land traversed.

6. The Secretary has authority to place inspectors on site to observe the Utility Company's installation activities and to request the presence of state or local police to assure the safety of highway travelers.
7. Upon reasonable demand and upon a finding by the Secretary that another Utility Company or person qualifies under this Policy, the Secretary may provide the necessary duct or ducts to the new applicant.
8. The Secretary recognizes that subsequent installations may result in potential construction conflicts of existing facilities. In all cases the new Utility Company is responsible for all damages to existing facilities or disruption of services, provided previously installed facilities were installed in accordance with field marker records and as-built plans submitted to the Secretary.
9. It is the responsibility of the Utility Company performing installation or maintenance work to locate and protect the facilities of other Utilities. The Secretary shall be indemnified and held harmless by Utility Company from any and all causes of action arising from the installation or maintenance of the utility facilities.

III. UTILITY PERMIT AGREEMENT

A. APPLICATION PROCEDURE

1. A Utility Company that proposes to install a facility longitudinally within a controlled access right-of-way shall request in writing, authority to do so from the Secretary. Thereafter, the Utility Company shall consult with the Secretary to achieve a plan that meets the objectives and conditions of this Policy. The Secretary will cooperate with the Utility Company in facilitating the proposed installation. When the Utility Company and the Secretary have reached agreement on a plan for Utility Company installation, the Utility Company shall submit formal drawings showing the location and specifications for the system. If the drawings are found to be in conformity with this Policy, the Secretary may enter into an Agreement with the Utility Company. By execution of this Agreement the Secretary approves the Utility Company's proposed use. The Utility Company may proceed with its proposed installation in conformity with the Agreement and this Policy.
2. The Agreement will contain provisions that implement the following general provisions:
 - a. To permit the Utility Company the right to enter upon the highway utility corridor for the purpose of conducting surveys and performing preliminary engineering studies and tests.

- b. To allow the right of ingress and egress to the Utility Company for installation or maintenance from the utility corridor.
- c. The requirement that the Utility Company will notify the Secretary of the location and time schedule for maintenance activities on the utility corridor.
- d. Provisions for the Utility Company to provide for liability insurance, notice of work starting and completion, traffic control provisions, and other pertinent items.
- e. Provisions for payments and fees that may include but are not limited to: 1) actual costs accrued by the Secretary and 2) negotiated fees for the joint use of right of way. This provision mandates that the Secretary shall not be liable for any costs accrued in the development of the Utility Company's plans.
- f. Clauses specifying the conditions under which the Secretary or the Utility Company may terminate the agreement and the Secretary's rights in the event of Utility Company's default under the Agreement.
- g. The rights of either party to the Agreement to correct any noncompliance with terms of the Agreement within a reasonable time.
- h. A penalty for non-compliance with terms of this policy or the Agreement.
- i. A clause determining ownership of the facilities in the event the Utility Company abandons or ceases to use its facilities. The Secretary may require the removal of the facilities.
- j. The maintenance, use or future expansion of the highway facility will not be impaired and any costs to relocate Utility Company facilities will be borne by the Utility Company.
- k. The Utility Company's responsibility for settlement of their trench backfill.
- l. If seeding is unsuccessful or in need of repair the Utility Company will be responsible for its repair.
- m. It is the responsibility of the Utility Company performing installation or maintenance work to locate and protect the facilities of other utilities. The Secretary shall be held harmless and indemnified by Utility Company from any and all causes of action arising from the installation or maintenance of the facilities.

- n. If the Utility Company fails to relocate the facilities in a timely manner following receipt of notice from the Secretary, the Secretary may remove the facilities and the cost of such removal shall be paid by the Utility Company.
- o. Additionally, if the Utility Company fails to relocate the utilities in a timely manner following receipt of notice from the Secretary, the Utility Company shall reimburse the Secretary for any liability the Secretary may incur from any construction claim attributable to Utility Company's failure to relocate utilities timely.

(This Page Intentionally Left Blank)

PART FOUR



ATTACHMENTS TO BRIDGES AND OTHER STRUCTURES OR INSTALLATIONS NEAR RETAINING WALL SYSTEMS



**PART FOUR
ATTACHMENTS TO BRIDGES
AND
OTHER STRUCTURES
OR
INSTALLATIONS NEAR RETAINING WALL SYSTEMS**

	PAGE
I. GENERAL PROVISIONS	4-1
A. HIGHWAY PERMIT	4-1
B. HAZARDOUS MATERIALS	4-2
II. FULLY CONTROLLED ACCESS HIGHWAYS	4-2
A. GENERAL.....	4-2
III. PERMITTED HIGHWAYS.....	4-2
A. DESIGN	4-2
B. LOCATION AND METHOD OF ATTACHMENT	4-3
C. OPEN EXCAVATIONS	4-4
D. MATERIALS.....	4-5
E. MAINTENANCE	4-5
F. PIPELINES	4-6
G. COMMUNICATIONS AND ELECTRIC LINES	4-6

PART FOUR
ATTACHMENTS TO BRIDGES
AND
OTHER STRUCTURES
OR
INSTALLATIONS NEAR RETAINING WALL SYSTEMS

I. GENERAL PROVISIONS

A. HIGHWAY PERMIT

1. Applications for all Utility Company attachments to bridges and structures or installations near a Retaining Wall System shall be authorized by a Highway Permit - Attachment to Bridges and Other Structures or Installations near Retaining Wall Systems (D.O.T. Form No. 310), which is included in the Appendix and is part of this policy incorporated by reference.
2. Permit requirements regarding, but not limited to, liability insurance are included in the Highway Permit-Attachment to Bridges and Other Structures or Installations near Retaining Wall Systems (D.O.T. Form No. 310).
3. Structure insurance coverage, for damages that may occur by reason of pipeline attachments carrying PETROLEUM, HAZARDOUS, AND/OR CORROSIVE PRODUCTS, shall be provided by the Utility Company in an amount determined by the District Engineer or designee for each bridge, structure or retaining wall system. The amount of insurance shall at a minimum meet or exceed the replacement cost of the structure as determined by the District Engineer or designee. The amount of insurance shall be reviewed annually and adjusted with the current cost of replacement of the structure.
4. A permit allowing a Utility Company the privilege of attaching its facilities to a bridge or highway structure or locating its facilities near a retaining wall system does not constitute any permanent right for such attachment or placement. Any removal, remodeling, maintenance, or relocation of the attachment or installation, will be promptly accomplished by the Utility Company at no cost to KDOT.
5. Provisions for a Utility Company attachment may be included during the design of a structure. See Section III.A, 2 for more information.

6. Utilities, when permitted, are to be installed, serviced, or maintained without access from the bridge deck or without interfering with the retaining wall system backfill.
7. The KDOT Bureau of Design - Bridge Section shall review and approve the Utility Company's proposal, particularly the measures to be taken to preserve the retaining wall system, the highway, its safe operation, maintenance and appearance.

B. HAZARDOUS MATERIALS

Permit applications for pipelines carrying hazardous materials shall contain emergency contact phone numbers available on a twenty-four hour basis, in case of emergency. The Utility Company shall notify the appropriate District Engineer or designee in writing of any changes in the calling list within seven (7) days of any change.

II. FULLY CONTROLLED ACCESS HIGHWAYS

A. GENERAL

1. Attachment to bridges and structures or installation of utilities near retaining wall systems on Fully Controlled Access Highways is prohibited, except when adverse economic impacts are documented and approval is granted in writing by the Secretary or the utilities provide service to maintain highway facilities.
2. When special and/or economic conditions warrant and an attachment to a bridge or structure or installation near a wall system on a Fully Controlled Access Highway structure is justified, then this Policy requirements will control as outlined below under "Permitted Highways", unless specific requirements are imposed by KDOT.

III. PERMITTED HIGHWAYS

A. DESIGN

1. The Utility Company is responsible for the design of their facility's attachment to a bridge or highway structure or installation near a retaining wall system and shall submit plans for review and approval. Attachment plans will include catalog cuts of attaching hardware and construction plans detailing the method of attaching the utility and position of the utility on any bridge or structure.

2. When a new structure is in the design stage, the Utility Company, through cooperation with the Bureau of Design – Bridge Section, may arrange for conduit and pipeline support systems to be included in the bridge construction plans. The additional cost of extra structural steel and fabrication needed to support the pipeline and/or conduit beyond what is needed for highway purposes will be determined, and this cost will be assessed to the Utility Company at a reasonable rate by the District Engineer at the time of design. This amount will be submitted along with the Highway Permit - Attachment to Bridges and Other Structures or Installations near Retaining Wall Systems (D.O.T. Form No. 310), which will include final design details outlining this attachment. The conduit itself for bridge attachment is to be supplied and installed later by the Utility Company. No Permit will be issued until all costs assessed to the Utility Company are paid in full.
3. Transition of alignment of utility from paralleling right-of-way to bridge or structure should be perpendicular to the roadway.
4. Satisfactory provisions for longitudinal conduit or pipeline movement due to temperature differentials or lineal expansion and contraction of the bridge shall be made in conduit or pipeline designs. Such provisions may be line bends, flexible couplings, or other methods acceptable under appropriate Industry Codes and Practices.
5. Utility Company lines will not be permitted through bridge abutments.
6. Manholes used to service the utility shall not be located in the bridge deck. Manholes shall be located beyond the edge of the wearing surface of the bridge or structure and outside of the roadway (pavement and shoulders) and median.

B. LOCATION AND METHOD OF ATTACHMENT

1. The Bureau of Design - Bridge Section may be contacted for recommended locations and acceptable types of attachments for various bridges. Although highway structure types and site conditions vary, some general standards have been adopted. The Utility Attachment Placement drawings are available in the Appendix.
2. Whenever possible, attachments will be placed on the downstream side of bridges. Generally, Utility Company pipelines and conduits will be attached to diaphragms located between girders.
3. Prohibited:
 - a. Anchors driven using the explosive type driving force method.
 - b. All welding and drilling on steel members.
 - c. All drilling in prestress and reinforced concrete girders.

- d. Attachment of conduits to bridge handrail and guardrail components.
- e. Pipelines using bridge members to resist forces generated by fluids in motion.

C. EXCAVATIONS

1. GENERAL

- a. Any open trench or excavation required in conjunction with bridge or structure attachments or installation near a retaining wall system will be backfilled within forty-eight hours after work is completed, in accordance with KDOT "Standard Specifications for State Road and Bridge Construction", or as directed by the District Engineer or designee.

2. BORING

- a. No utilities shall be placed within a distance 2 times H (the wall height) measured from the back face of the retaining wall system as shown in Figure 1.
- b. Trenching may be allowed a distance greater than 2 times H measured from the back face of the retaining wall following review of application (D.O.T. Form No. 310) and written approval by KDOT Bureau of Design – Bridge Section.
- c. Trenching may be allowed in front of the retaining wall at a distance greater than 1 time H measured from the front face of the wall following review of application (D.O.T. Form No. 310) and written approval by KDOT Bureau of Design – Bridge Section.

3. OPEN EXCAVATIONS

- a. No open excavations shall be allowed within 2 times H of the back face of the retaining wall.
- b. Open excavations may be allowed a distance greater than 2 times H measured from the back face of the retaining wall upon review of application (D.O.T. Form No. 310) and written approval by KDOT Bureau of Design – Bridge Section.
- c. Open excavations may be allowed in front of the retaining wall system at a distance greater than 1 times H measured from the front face of the retaining wall upon review of application (D.O.T. Form No. 310) and written approval by KDOT Bureau of Design – Bridge Section.

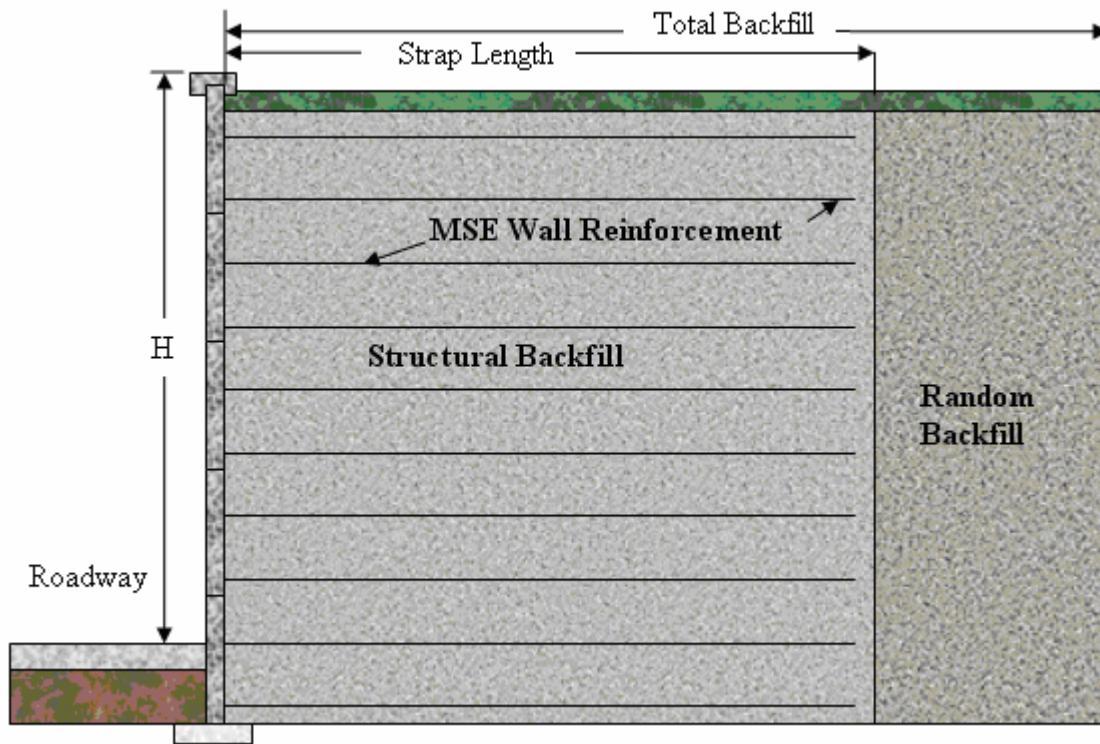

Figure 1 – MSE Wall Sketch

D. MATERIALS

1. All attachments to bridges and structures or placement near retaining wall systems shall be of durable materials designed for long service life expectancy and free from routine servicing and maintenance. Conformance with current applicable materials specifications and codes is mandatory.
2. All steel materials used in attaching a utility to a structure must be stainless or galvanized.

E. MAINTENANCE

1. Maintenance of the Utility Company facility is the responsibility of the Utility Company.
2. The installations shall be maintained to the satisfaction of the Secretary or designee.
3. Maintenance of the utility attachments to bridges will not be performed from the bridge deck.

F. PIPELINES

1. Pipelines carrying liquid petroleum, hazardous, or corrosive products will not be permitted to be attached to bridges or structures or installed near retaining wall systems except in extreme cases where the Utility Company can document that any other location is extremely difficult and of unreasonable cost to the Utility Company and to the consumer and the Secretary or designee approves the attachment or placement in writing.
2. Pipelines carrying natural gas, liquid petroleum products, or other volatile fluid or gas under pressure will require installation of emergency shut off valves. Valves shall be placed on each side of the bridge.
3. Pipelines shall be encased:
 - a. Attachment to Bridges: the length of the bridge with the casing carried beyond the back of the bridge abutments and opened or vented at each end to detect leakage, when the line carries fluids such as:
 - i. petroleum, hazardous and/or corrosive products, sewage etc., or
 - ii. water lines carried over railroads, streets, other highways, or freeways.
 - b. Placed near a Retaining Wall System: the length of the wall system with the casing carried beyond the end of the wall and opened or vented at each end to detect leakage, when the line carries fluids such as water, petroleum, hazardous and/or corrosive products, sewage, or etc.
4. Carrier and casing pipe shall be suitably insulated from electric power line attachments.

G. COMMUNICATIONS AND ELECTRIC LINES

1. Attachment to Bridges
 - a. Communication and electric power line attachments shall be suitably insulated, grounded and carried in protective conduit or pipe from point of exit from the ground to re-entry.

APPENDIX

APPENDIX

REFERENCES	5-1
CLEAR ZONE	5-2
KANSAS UNDERGROUND UTILITY DAMAGE PREVENTION ACT.....	5-4
HIGHWAY FENCING POLICY	5-5
GUIDELINES FOR KDHE MONITORING WELLS ON KDOT RIGHT-OF-WAY	5-8
MAILBOXES IN ROADWAY RIGHT OF WAY.....	5-9
STANDING PERMIT POLICY FOR LAND SURVEYORS	5-13
WELCOME SIGNS, CITY OWNED	5-15
SMALL CELL ANTENNA AND TOWER - ADDENDUM	5-15a
HORIZONTAL DIRECTIONAL DRILLING - ADDENDUM.....	5-15b
WIND FARM SETBACK - ADDENDUM	5-15c
WIRED UNDERGROUND TELECOMMUNICATIONS FOR BROADBAND - ADDENDUM	5-15e
Steel Bridge	
Bent Plat Diaphragms - Single or Multiple Conduit.....	5-16
Cross Frame Diaphragms - Single or Multiple Conduit	5-18
Concrete Beam Bridges – Single or Multiple Conduit	5-20
Reinforced Concrete Slab Bridge	5-21
Hanger and Clamp Types.....	5-22
TYPICAL SIGNING PLANS (UTILITY OPERATIONS)	
Traffic Control Specification Sheet	
TE-700 - General Traffic Control	5-23
TE-702 - Channelizing Devices.....	5-24
TE-704 - Road Closure	5-25
TE-710 - Traffic Control Signs	5-26
Work on or Near the Shoulder	
TE-720 - 2 or 4 Lane Highway	5-27
TE-722 - Divided Highway.....	5-28
Lane Closure	
TE-730 - 2 Lane Highway.....	5-29
TE-731 - 2 Lane Highway (Kansas Shift).....	5-30
TE-744 - 4 Lane Highway.....	5-31
HIGHWAY PERMIT FORMS	
Use of Highway Right-of-Way (D.O.T. Form No. 304).....	5-33
Cased Line Utility Waiver (D.O.T. Form No. 308)	5-35
Attachment to Bridges and Other Structures or Installations near Retaining Wall Systems (D.O.T. Form No. 310).....	5-37
INDEX	5-39

REFERENCES

1. "A Policy on the Accommodation of Utilities Within Freeway Right-of-Way", AASHTO, October 2005. American Association of State Highway and Transportation Officials Publication.
2. "A Guide for Accommodating Utilities within Highway Right-of-Way, October 2005", AASHTO, American Association of State Highway and Transportation Officials Publication
2. Program Guide Utility Relocation, Adjustments, and Accommodation on Federal-Aid Highway Projects Department of Transportation, Federal Highway Administration.
3. "Utilities" FHWA DOT, 23 CFR Part 645.
4. Statutory Provisions, 23 U.S.C. 109 and 111.
5. National Electrical Safety Code, Institute of Electrical and Electronic Engineers, Inc.
6. "Highway/Utility Guide", June 1993, U.S. Department of Transportation, Federal Highway Administration.
7. Pipeline Safety Regulations - Code of Federal Regulations, Title 49 - Transportation, Parts 191 and 192 - natural Gas; Part 195 - Liquid Petroleum Gas.
8. American Water Works Association Standards and Specifications, current issue. AWWA, 2 Park Avenue, N.Y., N.Y. 10016.
9. American Society for Testing and Materials (ASTM).
10. Manual on Uniform Traffic Control Devices, U.S. Department of Transportation, Federal Highway Administration.
11. "AASHTO Roadside Design Guide", Current Addition, American Association of State Highway and Transportation official publication.
12. Highway Maintenance Manual, Bureau of Construction and Maintenance, Kansas Department of Transportation.
13. Highway Sign Manual, Bureau of Traffic Engineering, Kansas Department of Transportation.
14. Standard Specifications for State Road and Bridge Construction, Kansas Department of Transportation.
15. State of Kansas Traffic Control Handbook for Flaggers

CLEAR ZONE

Clear Zone Distances (In feet from the edge of the through traveled way)

[U.S. Customary Units]

DESIGN SPEED	DESIGN ADT	FORESLOPES			BACKSLOPES		
		1V:6H or flatter	1V:5H TO 1V:4H	1V:3H	1V:3H	1V:5H TO 1V:4H	1V:6H or flatter
40 mph or less	UNDER 750	7-10	7-10	**	7-10	7-10	7-10
	750-1500	10-12	12-14	**	10-12	10-12	10-12
	1500-6000	12-14	14-16	**	12-14	12-14	12-14
	OVER 6000	14-16	16-18	**	14-16	14-16	14-16
45-50 mph	UNDER 750	10-12	12-14	**	8-10	8-10	10-12
	750-1500	14-16	16-20	**	10-12	12-14	14-16
	1500-6000	16-18	20-26	**	12-14	14-16	16-18
	OVER 6000	20-22	24-28	**	14-16	18-20	20-22
55 mph	UNDER 750	12-14	14-18	**	8-10	10-12	10-12
	750-1500	16-18	20-24	**	10-12	14-16	16-18
	1500-6000	20-22	24-30	**	14-16	16-18	20-22
	OVER 6000	22-24	26-32 *	**	16-18	20-22	22-24
60 mph	UNDER 750	16-18	20-24	**	10-12	12-14	14-16
	750-1500	20-24	26-32 *	**	12-14	16-18	20-22
	1500-6000	26-30	32-40 *	**	14-18	18-22	24-26
	OVER 6000	30-32 *	36-44 *	**	20-22	24-26	26-28
65-70 mph	UNDER 750	18-20	20-26	**	10-12	14-16	14-16
	750-1500	24-26	28-36 *	**	12-16	18-20	20-22
	1500-6000	28-32 *	34-42 *	**	16-20	22-24	26-28
	OVER 6000	30-34 *	38-46 *	**	22-24	26-30	28-30

* Where a site specific investigation indicates a high probability of continuing crashes, or such occurrences are indicated by crash history, the designer may provide clear-zone distances greater than the clear-zone shown in Table 3.1. Clear zones may be limited to 30 ft for practicality and to provide a consistent roadway template if previous experience with similar projects or designs indicates satisfactory performance.

** Since recovery is less likely on the unshielded, traversable 1V:3H slopes, fixed objects should not be present in the vicinity of the toe of these slopes. Recovery of high-speed vehicles that encroach beyond the edge of the shoulder may be expected to occur beyond the toe of slope. Determination of the width of the recovery area at the toe of slope should take into consideration right-of-way availability, environmental concerns, economic factors, safety needs, and crash histories. Also, the distance between the edge of the through traveled lane and the beginning of the 1V:3H slope should influence the recovery area provided at the toe of slope. While the application may be limited by several factors, the foreslope parameters which may enter into determining a maximum desirable recovery area are illustrated in Figure 3.2.

Source: Roadside Design Guide

CLEAR ZONE

Clear Zone Distances (In meters from the edge of the through traveled way)

Metric Units

DESIGN SPEED	DESIGN ADT	FORESLOPES			BACKSLOPES		
		1V:6H or flatter	1V:5H TO 1V:4H	1V:3H	1V:3H	1V:5H TO 1V:4H	1V:6H or flatter
60 km/h or less	UNDER 750	2.0 – 3.0	2.0 – 3.0	**	2.0 – 3.0	2.0 – 3.0	2.0 – 3.0
	750 – 1500	3.0 – 3.5	3.5 – 4.5	**	3.0 – 3.5	3.0 – 3.5	3.0 – 3.5
	1500 – 6000	3.5 – 4.5	4.5 – 5.0	**	3.5 – 4.5	3.5 – 4.5	3.5 – 4.5
	OVER 6000	4.5 – 5.0	5.0 – 5.5	**	4.5 – 5.0	4.5 – 5.0	4.5 – 5.0
70–80 km/h	UNDER 750	3.0 – 3.5	3.5 – 4.5	**	2.5 – 3.0	2.5 – 3.0	3.0 – 3.5
	750 – 1500	4.5 – 5.0	5.0 – 6.0	**	3.0 – 3.5	3.5 – 4.5	4.5 – 5.0
	1500 – 6000	5.0 – 5.5	6.0 – 8.0	**	3.5 – 4.5	4.5 – 5.0	5.0 – 5.5
	OVER 6000	6.0 – 6.5	7.5 – 8.5	**	4.5 – 5.0	5.5 – 6.0	6.0 – 6.5
90 km/h	UNDER 750	3.5 – 4.5	4.5 – 5.5	**	2.5 – 3.0	3.0 – 3.5	3.0 – 3.5
	750 – 1500	5.0 – 5.5	6.0 – 7.5	**	3.0 – 3.5	4.5 – 5.0	5.0 – 5.5
	1500 – 6000	6.0 – 6.5	7.5 – 9.0	**	4.5 – 5.0	5.0 – 5.5	6.0 – 6.5
	OVER 6000	6.5 – 7.5	8.0 – 10.0*	**	5.0 – 5.5	6.0 – 6.5	6.5 – 7.5
100 km/h	UNDER 750	5.0 – 5.5	6.0 – 7.5	**	3.0 – 3.5	3.5 – 4.5	4.5 – 5.0
	750 – 1500	6.0 – 7.5	8.0 – 10.0*	**	3.5 – 4.5	5.0 – 5.5	6.0 – 6.5
	1500 – 6000	8.0 – 9.0	10.0 – 12.0*	**	4.5 – 5.5	5.5 – 6.5	7.5 – 8.0
	OVER 6000	9.0 – 10.0*	11.0 – 13.5*	**	6.0 – 6.5	7.5 – 8.0	8.0 – 8.5
110 km/h	UNDER 750	5.5 – 6.0	6.0 – 8.0	**	3.0 – 3.5	4.5 – 5.0	4.5 – 5.0
	750 – 1500	7.5 – 8.0	8.5 – 11.0*	**	3.5 – 5.0	5.5 – 6.0	6.0 – 6.5
	1500 – 6000	8.5 – 10.0*	10.5 – 13.0*	**	5.0 – 6.0	6.5 – 7.5	8.0 – 8.5
	OVER 6000	9.0 – 10.5*	11.5 – 14.0*	**	6.5 – 7.5	8.0 – 9.0	8.5 – 9.0

* Where a site specific investigation indicates a high probability of continuing crashes, or such occurrences are indicated by crash history, the designer may provide clear-zone distances greater than the clear-zone shown in Table 3.1. Clear zones may be limited to 9 m for practicality and to provide a consistent roadway template if previous experience with similar projects or designs indicates satisfactory performance.

** Since recovery is less likely on the unshielded, traversable 1V:3H slopes, fixed objects should not be present in the vicinity of the toe of these slopes. Recovery of high-speed vehicles that encroach beyond the edge of the shoulder may be expected to occur beyond the toe of slope. Determination of the width of the recovery area at the toe of slope should take into consideration right-of-way availability, environmental concerns, economic factors, safety needs, and crash histories. Also, the distance between the edge of the through traveled lane and the beginning of the 1V:3H slope should influence the recovery area provided at the toe of slope. While the application may be limited by several factors, the foreslope parameters which may enter into determining a maximum desirable recovery area are illustrated in Figure 3.2.

Source: Roadside Design Guide

**KANSAS UNDERGROUND UTILITY DAMAGE PREVENTION
ACT
K.S.A. 66-1801 (DIG SAFE)**

1-800-334-7233 (Dig Safe)

Color Coding for Locating Utility Company Lines

RED	Electric Power Lines, Cables, Conduit and Lighting Cables
YELLOW	Gas, Oil, Steam, Petroleum, or Gaseous Materials
ORANGE	Communication, Alarm or Signal Lines, Cables or Conduit including Cable TV
BLUE	Water, Irrigation and Slurry Lines
GREEN	Storm Drain Lines/Sewer
PINK	Survey Markings
WHITE	Proposed Excavation

Tolerance Zone: The area within 24 inches (600 millimeters) of the outside dimensions in all horizontal directions of an underground facility.

KANSAS DEPARTMENT OF TRANSPORTATION HIGHWAY FENCING POLICY

I. PURPOSE

Fencing is one means of delineating and preserving the acquired control of access for a highway. It should be noted that right of way markers or controlled access signs may also be used with or without fence to identify the access control line.

II. POLICY

Access control fencing fence shall be placed along the access control line as may be shown on highway plans for Interstate highways and other full-access control highways where it is determined to be necessary to preserve access control.

Fencing may be placed on the access control line for other partial access control highways where it is deemed appropriate to delineate access control.

The determination of the appropriate use of access control fencing shall be accomplished at a field check. The type of fence best suited to the specific location should be provided as defined in Section III.

Any changes in the fencing, after the fencing review, shall be documented and maintained in a permanent record.

Access Control fence is owned and maintained by KDOT only for the purpose of delineating access control. Although adjacent property owners are permitted to pasture livestock against this fence, KDOT assumes no responsibility for constructing or maintaining a livestock-tight fence.

III. TYPES OF FENCE

When access control fencing is deemed appropriate under this policy and depending upon the nature of the adjoining property, the following types of fence shall be constructed either separately or in combination:

- A. Multi strand barbed wire or woven wire: non residential areas
- B. Woven wire: suburban type residential areas (generally where lot sizes are over one acre) and rural residences.

- C. Chain link: adjacent to developed areas, such as schools, churches, playgrounds, residential areas (generally where lot sizes are under one acre), industrial areas, etc., and for special screening effect where it is desirable.
- D. Single-wire cable: where aesthetics may be enhanced by a fence of lower height.

IV. FENCING PROCEDURES

- A. LOCATION: Normally, fences are located parallel and 6 to 12 inches inside the right of way line. For continuity, some fence may be erected substantially on a continuous line even though there may be some irregular right of way corners outside the fence line. Fence will not be constructed across drainage structure openings where the fence is winged into the wingwalls of these structures or carried over the top of the structure.
- B. SUBSTITUTION OF FENCE: When the adjacent owner desires to substitute another fence which is acceptable to KDOT and which serves the purpose of delineating access control, the owner may be allowed to do so, provided the owner enters into an agreement containing the following:
 1. The property owner is responsible for all costs associated with the construction of substitute fence. (Except where this substitute fence is to replace a property owner fence acquired during acquisition.)
 2. The fence is located along the right of way on the right of way line or on the owner's property. (On interstate in urban or suburban areas this will have to be on the owner's property because state owned fence will also be installed.)
The fence does not present a sight obstruction to traffic.
 4. The work is accomplished within the time set up for construction of the project. If the work is accomplished after construction of the project, the owner's plan must be approved by the District Engineer and the District Engineer may either remove or continue to maintain any existing state owned fence. On interstate in urban or suburban areas the state owned fence will remain in place.
 5. Ownership and maintenance of the substituted fence shall be vested in the property owner.
 6. If any of the fence installation requires activity on the right of way a permit will be required.
 7. A time frame within which the substitute fence will be installed. If the work is not completed in the time frame agreed between the owner and KDOT, then KDOT will erect fence consistent with this policy.
- C. INTERSECTING PRIVATE FENCE:

1. When KDOT is constructing access control fence, they shall connect all intersecting private fences by the placement of an end post assembly.
 2. When a property owner desires to construct an intersecting fence to existing KDOT fence, the property owner shall place an end post assembly at the intersection with KDOT fence.
- D. FRONTAGE/ACCESS ROADS: Along highways with frontage/access roads within the right of way, the access control fence may be located between the frontage/access road and the through traffic lanes or an interchange ramp.
- E. SALVAGE OF EXISTING FENCE: Where existing private fence is acquired, the property owner will be allowed to salvage their fence prior to commencement of construction or utility relocation. If the owner's salvage activities create a need for temporary fence, the owner shall be responsible for its installation.
- F. TEMPORARY FENCE: When construction activities involve removing existing KDOT fence or fence acquired by KDOT from the owner which the owner chooses not to salvage, the contractor will be responsible for furnishing and installing any necessary temporary fence until such time that the permanent fence is in place.
- G. WATER GAPS: At locations where the fence is tied into the wingwalls of the drainage structure or carried over the top of the structure, the property owner may be allowed to erect fence along the right of way line. The property owner shall install end post assemblies and shall be responsible for the maintenance of the fence, so erected by the property owner.
- H. FENCING FOR TWO-LANE ROADWAY ON FOUR-LANE RIGHT OF WAY: The fence is normally placed at the final right of way or access control lines in accordance with this policy.

APPROVED BY:

Warren L. Sick 1/09/02
Warren L. Sick Date

Assistant Secretary and State Transportation Engineer

GUIDELINES FOR KDHE MONITORING WELLS ON KDOT RIGHT OF WAY

1. When an application, described in the memorandum of Understanding is submitted to KDOT, the application must include five (5) copies of a drawing of proposed well locations along with property and right of way lines
2. The permit shall be obtained by the petitioner doing the work. The petitioner shall acquire all the necessary signatures on the permit, i.e. "City" approval if necessary, and give KDOT a reasonable amount of time (30 days) to issue the permit.
3. KDOT may issue the permit conceptually authorizing a specific number of wells at proposed locations to be drilled. KDOT reserves the right to deny approval of specific wells that can be located off KDOT right of way/easement. It will then be the petitioner's responsibility to prove that all other possible locations have been exhausted before KDOT approves these sites. The petitioner shall contact KDOT (by phone) for approval as to the exact location of each well before installation, and as the contamination pattern is being established. This notification will occur no less than one working day before drilling on KDOT right of way/easement. KDOT will designate a contact representative for each permit when it is issued.
4. The petitioner shall follow the KDOT Utility Accommodation Policy and comply with the Highway Use of Right of Way Permit Agreement.
5. Wells shall be located outside of the highway clear zone, see KDOT Utility Accommodation Policy for chart. Wells shall not be located in the toe of the slope.
6. The District will decide if wells will be flush with the ground or raised, and this shall be stated on the permit. Wells will be installed in accordance with current KDHE standards. Ground markers are to be located at the outer limits of the right of way line. During maintenance/construction activities, the petitioner will locate and mark wells as needed.
7. During installation and monitoring, the petitioner shall use approved traffic control procedures.
8. KDOT shall be notified whenever the petitioner is going to access KDOT right of way, whether this is for installation or monitoring of a well. The petitioner is also responsible for notifying Dig Safe prior to drilling.
9. During monitoring, the petitioner may park their vehicles on the shoulder and/or roadway only with the KDOT Engineer's permission. They may park their vehicle on the cross road right of way.
10. KDOT shall be notified when a well is to be abandoned. Wells will be plugged using current KDHE approved method.

Mailboxes in Roadway Right of Way

Since mailboxes are normally located within the “clear zone” of the traveled way, crashworthy characteristics of mailboxes and supports are a concern. Also, mailboxes’ close proximity to the roadway often results in damage by maintenance equipment. The following information suggests design and placement of mailboxes and supports.

Placement Recommendations

Lateral installation of mailboxes must offer the mail carrier easy access to the box from the delivery vehicle as well as necessary clearance from the traveled way. The following illustrations provide suggested installation locations relative to several road and street situations. (All proposed mailbox placements should be reviewed with the local post office prior to actual installation.)*

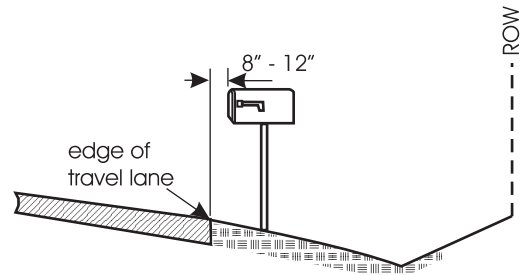

Lateral placement with no shoulder or turnout

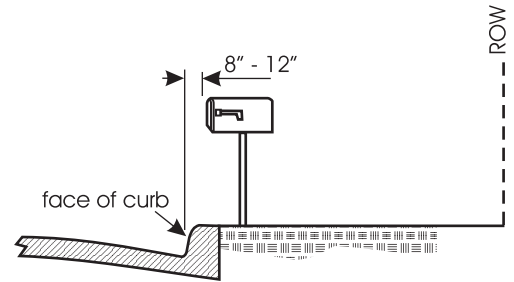

Lateral placement with curb and gutter

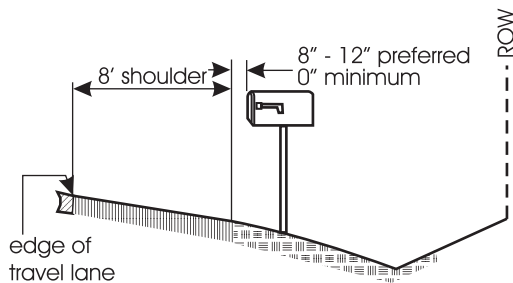

Lateral placement with shoulder or turnout

The height of mailboxes is governed by the United States Postal Service, which recommends an installation height of 42 to 48 inches, again for convenient access by the mail carrier.

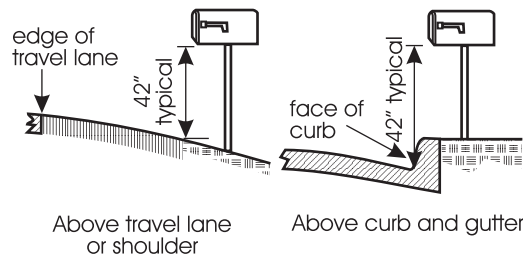

Height of the mailbox

*Note: In consideration of uniformity and crashworthy features, some agencies have established programs to furnish and install approved design supports if property owners provide the mailbox.

One particular support design has been used effectively in some areas to reduce damage from snow plows and other maintenance equipment. This post provides a cantilever support, which places the vertical post section several additional feet from the traveled way. An example of this design is shown below.

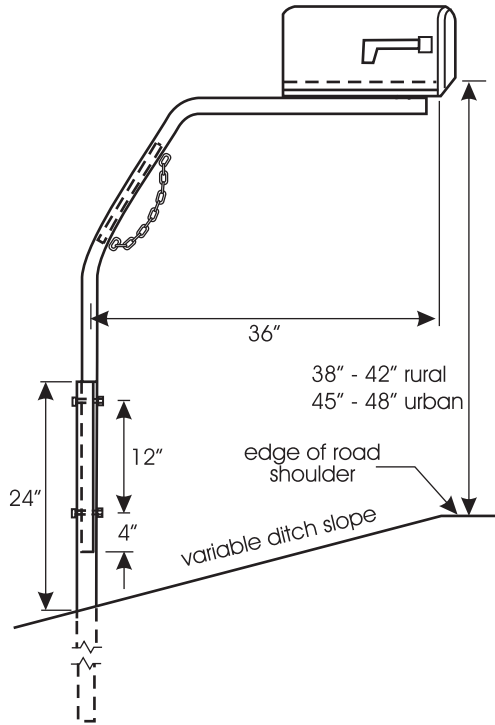

Mailbox support (steel pipe and sign post)

Mail delivery can be made safer and more convenient through the use of turnouts. These designs can be most effective where multiple mailboxes are present requiring the carrier to spend a considerable length of time in one location. An example of a suggested turnout design is shown in the following figure.

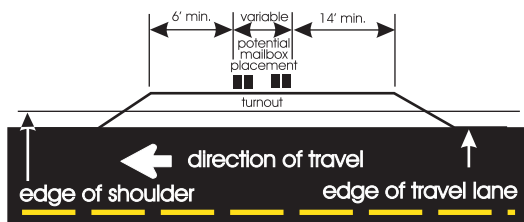

Longitudinal placement for turnout

Mailbox installations near intersections also should be studied for the potential safety of road users and mail carriers as well as convenience of the home owner. Suggested locations for mailbox installations are shown in the following figures.

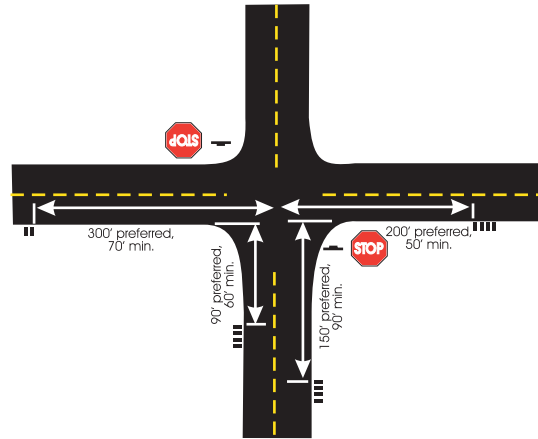

Mailbox placement at rural intersections where through road speed limit \geq 55 mph

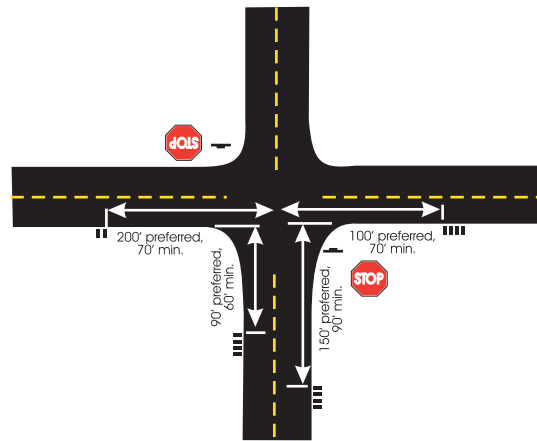

Mailbox placement at intersections where through road speed limit $<$ 55 mph

Mailbox Supports

Supports or posts for mailboxes are of two general types: single support and multiple support. Although many existing mailboxes are supported on wood posts or by other means, crash testing has indicated that light metal or plastic are the best materials for meeting crash-worthy recommendations.

Support for a single mailbox can be provided by a channel post or a 2 to 2-1/2-inch thin wall steel pipe. Two small mailboxes can be mounted on a single support with the use of a proper adapter plate. Single supported mailboxes should not be placed closer than 2 feet apart, with a maximum of two single supports grouped together to avoid the “ramp effect” on vehicle impact. American Association of State and Highway Transportation Officials (AASHTO) guidelines recommend a spacing of 3/4 the mounting height. The following shows a suggested single mailbox support.

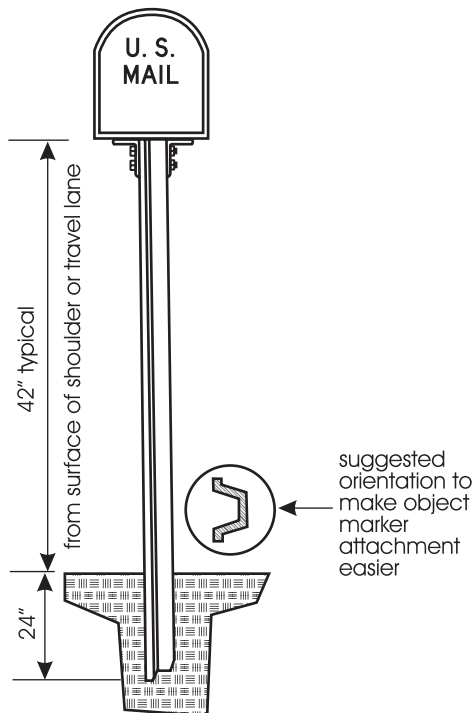

Installation of single mailbox support

Depending on the size of the mailboxes, up to five individual boxes can be installed on multiple support, commonly referred to as a “coat hanger” design. Adjacent multiple supports should not be placed closer than 4 feet, with no limit on the number of adjacent groups. The following figures show recommended multiple support design.

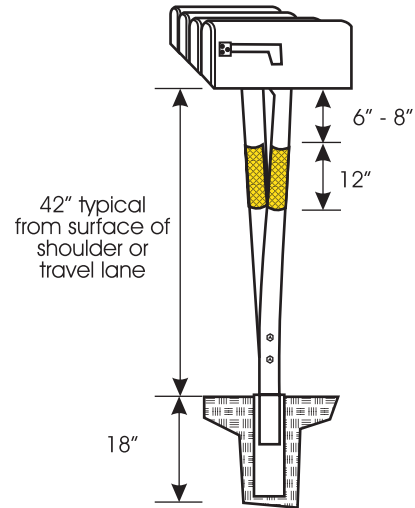

Installation of multiple mailbox support

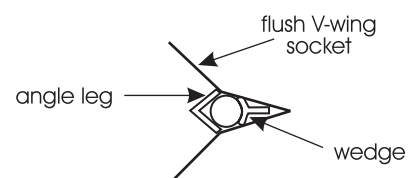
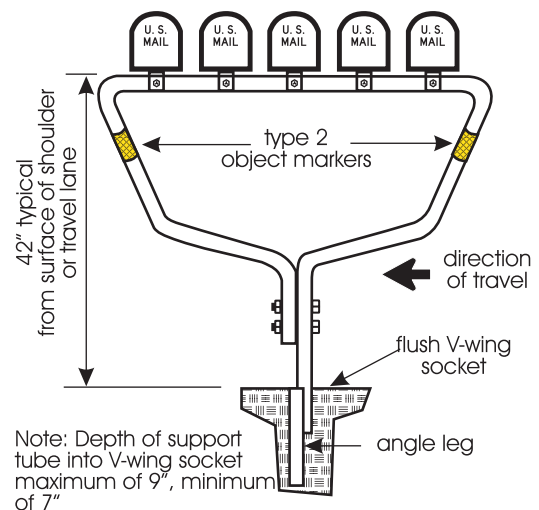

Installation of multiple mailbox support

These designs have been implemented in Texas. The Texas Department of Transportation and AASHTO's *A Guide for Erecting Mailboxes on Highways*, published in 2002, can provide more detailed information on design and experience.

Object Markers for Mailboxes

Use of proper object markers can provide increased visibility of mailbox installations at night. The markers should be blue. Red is not an approved color for this application.

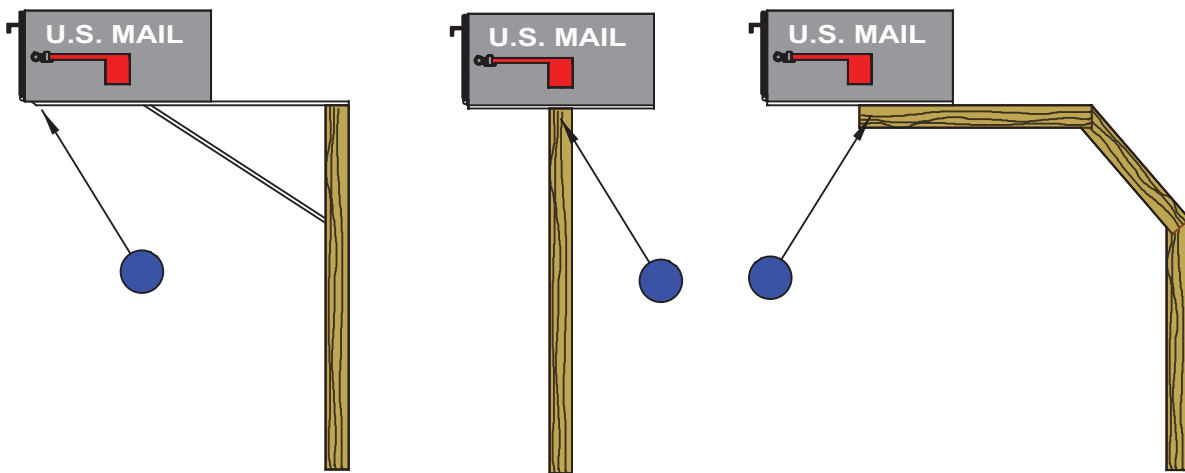

SUGGESTED MARKER PLACEMENT FOR MAILBOXES

NOTE:
Mailbox markers are to be blue in color.

NOTE:
Installation and maintenance of mailbox markers shall be the responsibility of the property owner.

Kansas Department of Transportation

Standing Permit Policy for Land Surveyors working within the State Highway System Right-of-Way

The Kansas Department of Transportation (KDOT) establishes the following policy regarding survey activities within the Right-of-Way of the State Highway System of the State of Kansas. All survey activity occurring within the Right-of-Way of the State Highway System shall be governed by this policy. Surveyors functioning as a subcontractor (Contractor Construction Staking) on a construction project shall abide by the contract requirements, but will not be required to obtain a permit. KDOT survey personnel are also exempted from the permit requirement.

A surveyor, as an individual or as a business firm (henceforth referred to as the Surveyor), shall obtain a Standing Permit from each District in which their work is to be performed. Standing permits may be granted, at the discretion of the District Engineer, to individuals or firms with satisfactory compliance with permit conditions. Standing permits may be issued for a maximum period of one year.

The Surveyor shall request a standing permit by submitting a D.O.T. Form No. 304 – Highway Permit, Use of Right of Way. A separate permit request shall be submitted for each District. When the request has been approved and returned to the Surveyor, it shall be the responsibility of the Surveyor to have a copy of the signed permit on site while working within the State Highway System Right-of-Way.

All traffic control used on the State Highway Right-of-Way shall conform to the current Manual on Uniform Traffic Control Devices (MUTCD) and established State Traffic Control standard drawings. Traffic Control Standard drawings (TE700SI, TE702SI, TE704SI, TE710SI, TE720SI, TE722SI, TE730SI, TE744SI, TE746SI and TE748SI or other applicable standard drawings), developed from the MUTCD for ease of interpretation are available for reference.

The Surveyor shall notify the appropriate KDOT Area Office prior to actually commencing any activities within the State Highway Right-of-Way covered by the standing permit. The area office shall also be notified upon the completion of work. The location and dates of the beginning and completion of all work will be documented and logged by the Surveyor. This documentation log shall be kept with the standing permit. Approval of such work may be given by e-mail, fax or in writing. The Surveyor shall record the name of the individual giving authorization and the date authorization was received.

Vehicles within the State Highway Right-of-Way and within 30 feet of the travel way shall utilize amber rotating lights or amber strobe lights mounted on the top of the vehicle. Unattended vehicles and equipment should be parked off of State Highway Right-of-Way or no closer than 30 feet from the travel way.

All personnel working outside of a vehicle and anywhere within the State Highway Right-of-Way shall wear, as a minimum, a high visibility (American National Standards Institute, Inc. (ANSI) Class II) safety vest with retro-reflective striping.

The permit of any individual or firm who fails to follow this policy may be revoked. Future requests for a permit may also be denied for failure to follow this policy.

D.O.T. Form No. 304 and Traffic Control Standard drawings may be picked up at any KDOT Area Office. There will be no fee for a standing permit.

(11-06-2003)

Recommended by:



G. David Comstock, P.E.
Director of Engineering and Design

11-14-03

Date



Mike Crow, P.E.
Director of Operations

11/16/03

Date

Approved by:

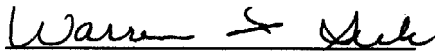

Warren L. Sick, P.E.
Assistant Secretary &
State Transportation Engineer

11/17/03

Date

Kansas Department of Transportation

Policy on City Owned Welcome Signs Along the Highway Right of Way

BACKGROUND: Except for official highway signs that are the city's responsibility according to the Connecting Link Maintenance Agreements, the installation, by cities, of signs and other structures on the highway right of way is generally discouraged. However, in some instances, cities have requested and received permission to install signs on highway right of way near the city limits that identify the city and present a positive statement about the city's beautification efforts. In recognizing this, the Kansas Department of Transportation needs to establish a policy to ensure that this process is handled equitably, and that a clear and safe roadside is maintained without compromising the integrity of the standard highway signs in that area.

POLICY: If a suitable location is not available on city owned property or private property, and there is a suitable location available on highway right of way, a city may install Welcome signs on State-owned highway right of way through the permit process if the following criteria is met:

- The message must be limited to the city's name, or either of the messages "Welcome to (city)" or "(city) Welcomes You." In addition, the city's officially adopted graphical logo may also be included on the sign.
- A graphical rendition of the proposed sign should be included with the permit request.
- The sign shall be located outside of the clear zone applicable to the highway at the sign's location.
- The sign should be located near the city limit, and preferably just inside the city limits.
- The sign should not interfere or compete with any official highway signs in the area.
- The sign must be located so that it does not block the visibility of, nor the sight distance from, any entrances or side roads.
- The city must agree to assume all costs associated with the installation and maintenance of the sign, and any lighting and landscaping associated with it. The city must also agree to mow the grass/vegetation on a regular basis within a 3 m (10 foot) radius around the sign.
- In cases where a sign must be relocated because of a highway project, the city must assume full responsibility for the relocation of the sign to a suitable location.

Approved:

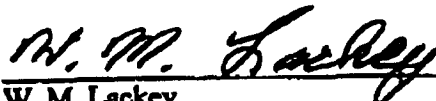
W. M. Lackey
Assistant Secretary and
State Transportation Engineer

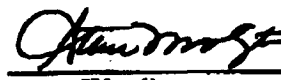
Steve Woolington
Director of Operations

Date:

5-28-99

Addendum - Utility Accommodation Policy
Small Cell Antenna and Tower

Revised September 28, 2018

KDOT / Wireless Telecommunications
Distributed Antenna System (DAS) / Small Cell Antennas

This is an exception to paragraph I.A.5.

These seven requirements must be met in addition to other requirements contained in the KDOT Utility Accommodation Policy

1. The utility pole shall be a standard utility pole / monopole of wood, fiber glass, metal or concrete construction not to exceed 3' 6" diameter at the base. Pole installation is to be by direct bury, no concrete foundation or footing.
2. Total height to the top of the antenna above the ground line shall not exceed 125'.
3. The Pole shall be placed within 2' of the right-of-way line, and be outside the designated clear zone of the highway.
4. Support equipment shall be in a NEMA housing attached to the pole. No equipment building allowed.
5. An external power disconnect attached to the NEMA cabinet shall be made available to de-energize the antenna and a second external disconnect shall be made available to de-energize the power supply to the equipment cabinet for KDOT and/or emergency personnel.
6. Parking is prohibited on shoulder or edge of road for service or routine maintenance. Evidence of an existing entrance, a side road, an accessible ditch (6:1 foreslope or flatter) or access from adjacent property (such as a parking lot) shall be available at the time of issuing the permit.
7. Installations shall not be allowed on fully controlled access highways. Installations on partially controlled access highway shall be at the discretion of the District Engineer.

W. Clay Adams
Bureau Chief of Maintenance

Addendum - Utility Accommodation Policy
Horizontal Directional Drilling

Date: September 5, 2018

Part 2 – Utilities on Permitted Highways

IV. Encasement of Utilities

C. Boring

1. Pits for boring, tunneling, horizontal directional drilling (HDD), or jacking will typically be outside of the right-of-way. If bore pits are allowed on right-of-way, they should be located at the outer edge of the right-of-way. Bore pits will not be permitted in the highway median and will not be permitted closer to the roadway than toe of fill in fill sections or toe of shoulder slope in ditch sections.
2. Casing and pipeline installations shall be accomplished by dry boring, tunneling, HDD, jacking, trenching, or other approved methods.
 - a. The utility shall not use water jetting or tunneling, but water-assisted or wet boring may be permitted if determined by the District Engineer to not result in excessive erosion or unacceptable moisture conditions in the roadway subgrade.
 - b. The hole diameter resulting from bored or tunneled installations shall not exceed the outside diameter of the utility pipe, cable or casing including coating by more than 1.5 inches on pipes with an inside diameter of 12 inches or less; or two inches on pipes with an inside diameter greater than 12 inches.
 - c. If the oversized excavation is not already filled by the drilling slurry after product pull through, the void shall be grouted. Grout or other approved backfill material shall be used for pipe of 12 inches or more in diameter, and for over breaks, unused holes or abandoned pipe. The composition of the grout shall be a cement mortar, a slurry of fine sand or fine granular material, subject to the District Engineer's approval.
 - d. The utility shall follow manufacturer's guidelines and industry standards for equipment set-up and operation. The utility shall assess soil conditions to determine the most appropriate installation technique. Underground bore paths or tunnels shall be tracked and recorded by the utility. Failed bores shall be appropriately abandoned by the utility.
 - e. Drilling fluids shall be prepared and used according to fluid and drilling equipment manufacturer guidelines. The utility shall use fluid containment pits at both bore entry and exit points, and shall use appropriate operational controls in order to avoid heaving or loss of drilling fluids from the bore.
 - f. Antifreeze additives shall be non-toxic and biodegradable products.
 - g. Depending upon chemical composition of the specific method of disposal, improperly disposed drilling fluids may be classified as solid wastes or illicit

Addendum - Utility Accommodation Policy
Horizontal Directional Drilling

Date: September 5, 2018

discharges and in general, shall be pumped or vacuumed from the construction area, removed from the right-of-way and disposed of at permitted facilities that specifically accept such wastes.

- h. Disposal of drilling fluids into storm drains, storm sewers, roadside ditches or any other type of man-made or natural waterway is expressly prohibited.

Addendum - Utility Accommodation Policy
Wind Farm Setback

Date: September 9, 2018

KDOT has several concerns regarding wind turbine setback from a state highway, including but not limited to; blade fragmentation, ice shed/throw, turbine fire, tower failure, and future highway expansion. Because of these concerns, KDOT observes a setback of 1.5 x the tip height back from the highway right-of-way line.

The width of the ROW varies according to geographic features. Please contact the Survey Office in the Bureau of Right-of-Way to request a copy of the plan sheets to determine the exact width of the right-of-way.

W. Clay Adams
Bureau Chief of Maintenance

Addendum—Utility Accommodation Policy (UAP)

Wired Underground Telecommunications for Broadband

Effective: January 3, 2020

STATEMENT OF POLICY

Current federal and state legislation and executive initiatives recognize the need for broadband infrastructure as essential to public health, safety, education, transportation, job growth, and economic development, especially for rural and other underserved areas. FHWA has asked State transportation leaders to consider accommodating broadband infrastructure on highway rights-of-way to help achieve these goals and needs while maintaining safe and efficient highway operations. (See Letter from Administrator Mendez to State Departments of Transportation (August 20, 2013). The Secretary finds that broadband facilities serve a public interest and underground broadband facilities may be located and maintained on non-interstate highway rights-of-way with minimal risk to the free and safe flow of traffic. Thus, continued restrictions in the UAP on such installations will result in severe hardship in rural and underserved areas and is contrary to the public interest.

This Addendum to the UAP is being issued to further accommodate broadband facilities on non-interstate highway right-of-way. This Addendum modifies Part One, General Policy; Part Two, Utilities on Permitted Highways, and Part Three, Utility Accommodation Policy For Fully Controlled Access Highways.

1. Telecommunications public utilities and other broadband service providers (Providers) seeking to install underground fiber optic cable, coaxial cable, DSL, or other facilities that support telecommunications service for broadband, as defined in K.S.A. 66-1,187, (Underground Broadband Facilities) may request from the Secretary a Highway Permit (D.O.T. Form 304) to install such underground facilities along non-interstate fully controlled access highways, partially controlled access highways, and nonaccess controlled highways. On these non-interstate routes, Underground Broadband Facilities shall comply with Parts One, Two, and Four of the UAP except as otherwise modified in this Addendum. Underground Broadband Facilities and other utility facilities on interstate right-of-way continue to be governed by Part Three of the UAP.
2. Underground Broadband Facilities may be installed parallel to the roadway (longitudinally) between the right-of-way line and toe of backslope (back line of the ditch bottom) on the rights of way of non-interstate fully controlled access highways, partially controlled access highways, and nonaccess controlled highways. Such longitudinal installations shall be:
 - a. Placed within the Utility Corridor established by the Secretary if both physically possible and commercially practicable or placed outside such Utility Corridor but no closer to the roadway than the toe of backslope if the District Engineer determines placement within the Utility Corridor is not physically possible or commercially practicable.

- b. Installed at a minimum depth of 42 inches below the existing ground line by boring, plowing, trenching, or a combination thereof to maintain a parallel, uniform path beneath (not around) existing surface or subsurface obstructions unless the District Engineer approves a variance.
 - c. Placed in conduit that includes a trace wire or be comprised of armored fiber cable or other material that the District Engineer determines allows tracing.
3. Hand holes for Underground Broadband Facilities less than or equal to 3 foot x 4 foot for branch connections may be located on highway right-of-way at interchanges, rest areas, or side roads in a location approved by the District Engineer; on other department property approved by the District Engineer; or on private right-of-way. At the District Engineer's discretion, hand holes less than or equal to 3 foot x 4 foot to aid line installation may be located mid-mile. Hand holes shall be flush and maintained in a flush condition to the existing ground and structurally adequate to withstand highway maintenance operations and operations by other users of the right-of-way. Hand holes larger than 3 foot x 4 foot and Vaults shall be located on private right-of-way.
4. After a Provider demonstrates that such structure's location on private right-of-way is not physically possible or commercially practicable, Point of Presence (POP) Buildings for Underground Broadband Facilities may be located on highway right-of-way at interchanges, rest areas, or side roads in a location approved by the District Engineer or on other department property approved by the District Engineer. POP Buildings on highway right-of-way may only be accessed from interchanges, side roads, existing entrances, or adjacent property. Providers shall not access POP Buildings from roadway shoulders or ditches.
5. The Provider shall install permanent markers at or near the right-of-way line and at appropriate intervals showing the approximate location of its Underground Broadband Facility. In addition, the Provider shall prepare As-Built Plans that depict the following minimum information in .pdf format and *.KMZ, Shapefile, Geodatabase or other mutually agreed format. As-Built Plans and the other information listed below shall be furnished by the Provider to the District Engineer.
 - a. Show (a) location of installed Conduit, hand holes and Vault locations relative to permanent landmarks and facilities and (b) distances from the centerline roadway and other features (such as mileposts, boundary and utility crossings, waterways, etc.). Clearly depict any turns in installation route at road crossings. Clearly depict non-parallel portions of the route approved by the District Engineer to follow the right-of-way line rather than the roadway or to avoid obstructions upon the Provider showing that boring or other installation method to avoid such an obstruction is not physically possible or commercially practicable.

- b. At 150' intervals, GPS coordinates for all installed Conduit and related facilities in shapefile format. GPS accuracy within 1 foot. Also furnish locations of and GPS coordinates for fiber optic marker locations (facility location signs or markers).
- c. Conduit information (color, type, length, expansion joints, etc.).
- d. Note any deviation from the *Utility Accommodation Policy* (depth, etc.).

GIS data format shall include the following fields, where * indicates attribution for the field is required.

SHAPE*; OID or UniqueID*, Feature*, Description

Shape: This is the GIS shape

OID: Unique, indexed long integer identifier. Most GPS systems will automatically populate an Object ID, which is sufficient.

Feature: This field describes the feature that was collected in the field. Valid feature attributes shall include: Handhole, Conduit, Vault, Landmark, ROW point, Marker Sign, Expansion Joints, splices. Other valid feature types may be mutually agreed upon.

Description: This field includes information, such as color, type, length etc.

- 6. No fee will be required for processing and issuing a Highway Permit under this Addendum.
- 7. Wireless telecommunication facilities that support broadband are addressed in Part One and Two of the UAP and the Small Cell Antenna and Tower Addendum, September 28, 2018.

W. Clay Adams
Bureau Chief of Maintenance

KANSAS DEPARTMENT OF TRANSPORTATION

UTILITY ATTACHMENT PLACEMENT

For a Steel Superstructure Bridge with bent plate diaphragms

Support Spacing
 _____ meters
 (_____)feet

Diameter Conduit(s)
 _____ mm
 (_____)inches

Weight (Includes Conduit,
 Support System and Cables)
 _____ kg/ m
 (_____)lbs./ ft.

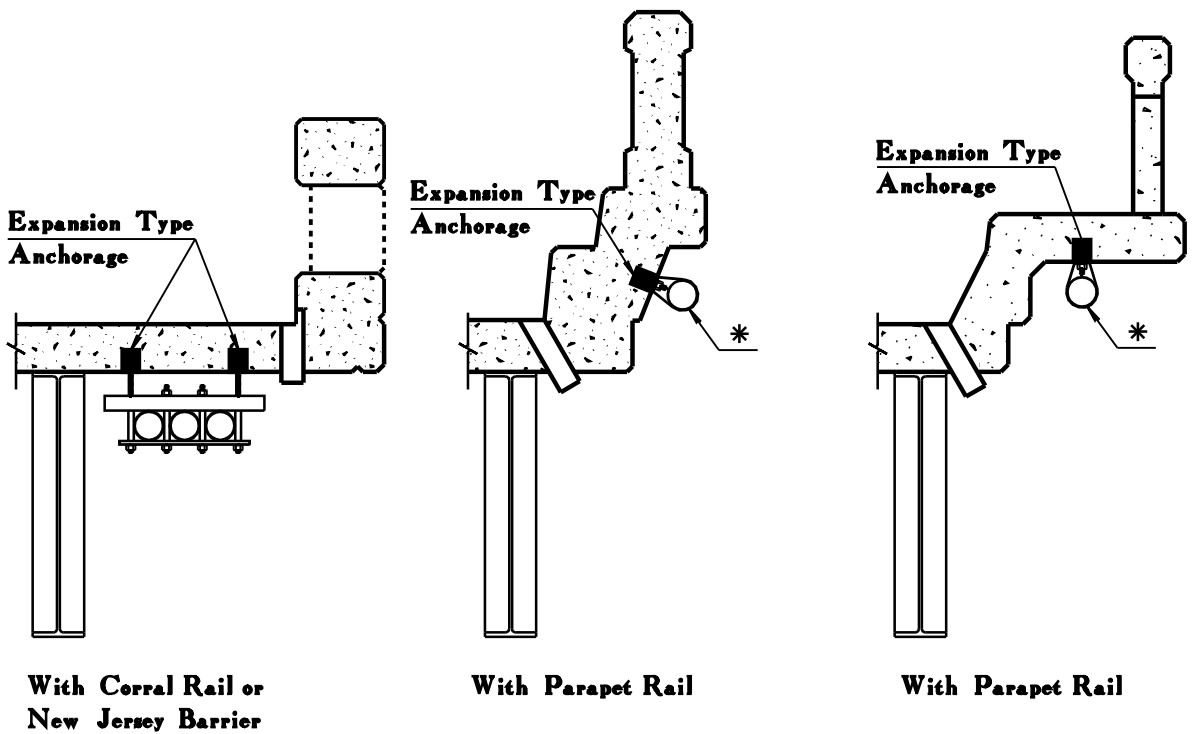

SINGLE OR MULTIPLE CONDUITS - ALTERNATE LOCATIONS -

* Drilling, welding, or cutting of any structural steel is not allowed.
 Use Conduit or Beam Clamps in place of drilling or cutting.

NOTE: All steel materials used in attaching a utility to a structure must be stainless or galvanized.

Plot Date : 5/9/2007
View= Plot1
Plotted By : ronalds
Plot File : W:\Bridge Inspection\Br-School\Bridge Insp Manuals\Utility Attachments\utbr men.dgn

KANSAS DEPARTMENT OF TRANSPORTATION

UTILITY ATTACHMENT PLACEMENT

For a Steel Superstructure Bridge with bent plate diaphragms

Support Spacing
_____ meters
(_____)feet

Diameter Conduit(s)
_____ mm
(_____)inches

Weight (Includes Conduit,
Support System and Cables)
_____ kg/ m
(_____)lbs./ ft.

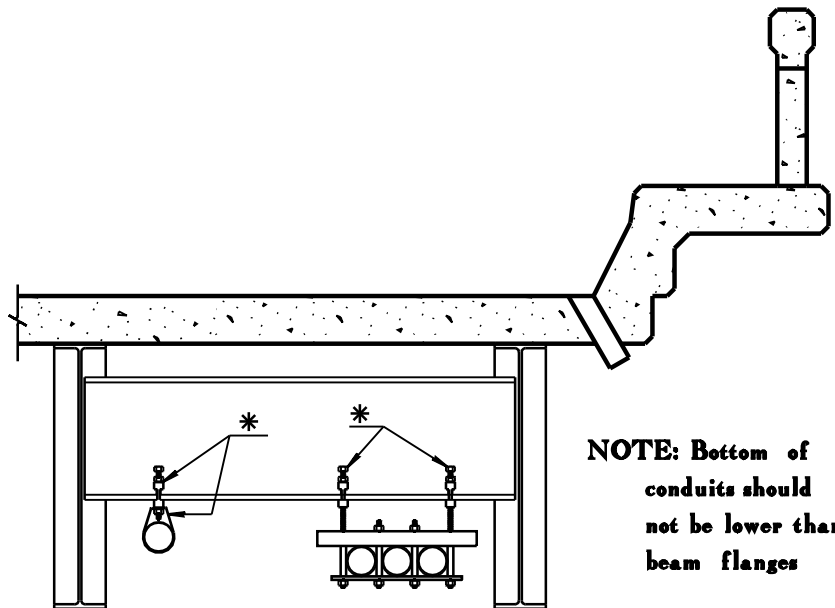

NOTE: Bottom of conduits should not be lower than beam flanges

SINGLE OR MULTIPLE CONDUITS - PREFERRED LOCATION -

(See additional sheet for - ALTERNATE LOCATION -)

* Drilling, welding, or cutting of any structural steel is not allowed.
Use Conduit or Beam Clamps in place of drilling or cutting.

NOTE: All steel materials used in attaching a utility to a structure must be stainless or galvanized.

Plot Date : 5/9/2007

View= Plot1

Plotted By : ronalds

Plot File : \\A\Bridge Inspection\B\School\Bridg Insp Manuals\Utility Attachments\ulbr man.dgn

KANSAS DEPARTMENT OF TRANSPORTATION

UTILITY ATTACHMENT PLACEMENT

For a Steel Superstructure Bridge with cross frame diaphragms

Support Spacing
 _____ meters
 (_____)feet

Diameter Conduit(s)
 _____ mm
 (_____)inches

Weight (Includes Conduit,
 Support System and Cables)
 _____ kg/ m
 (_____)lbs./ ft.

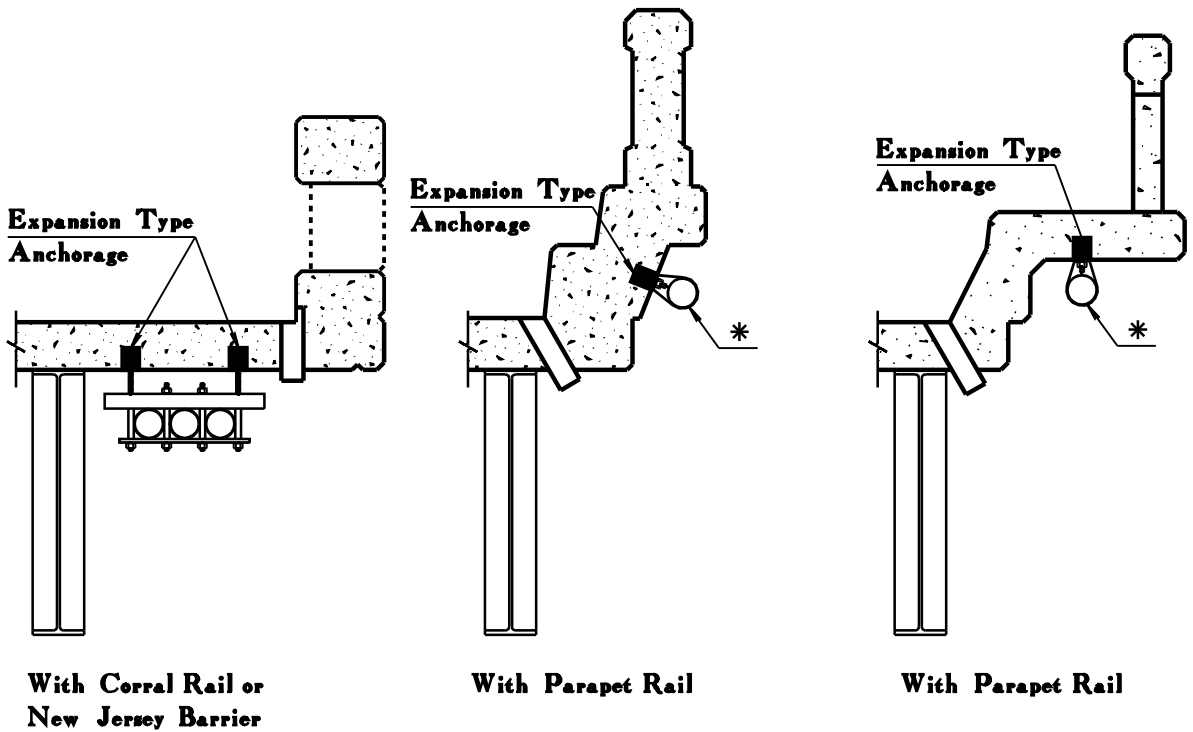

SINGLE OR MULTIPLE CONDUITS - ALTERNATE LOCATIONS -

* Drilling, welding, or cutting of any structural steel is not allowed.
 Use Conduit or Beam Clamps in place of drilling or cutting.

NOTE: All steel materials used in attaching a utility to a structure must be stainless or galvanized.

Plot Date : 5/9/2007

View= Plot2

Plotted By : ronalds

Plot File : W:\Bridge Inspection\Br-School\Bridge Insp Manuals\Utility Attachments\utbr men.dgn

KANSAS DEPARTMENT OF TRANSPORTATION

UTILITY ATTACHMENT PLACEMENT

For a Steel Superstructure Bridge with cross frame diaphragms

Support Spacing
_____ meters
(_____)feet

Diameter Conduit(s)
_____ mm
(_____)inches

Weight (Includes Conduit,
Support System and Cables)
_____ kg/ m
(_____)lbs./ ft.

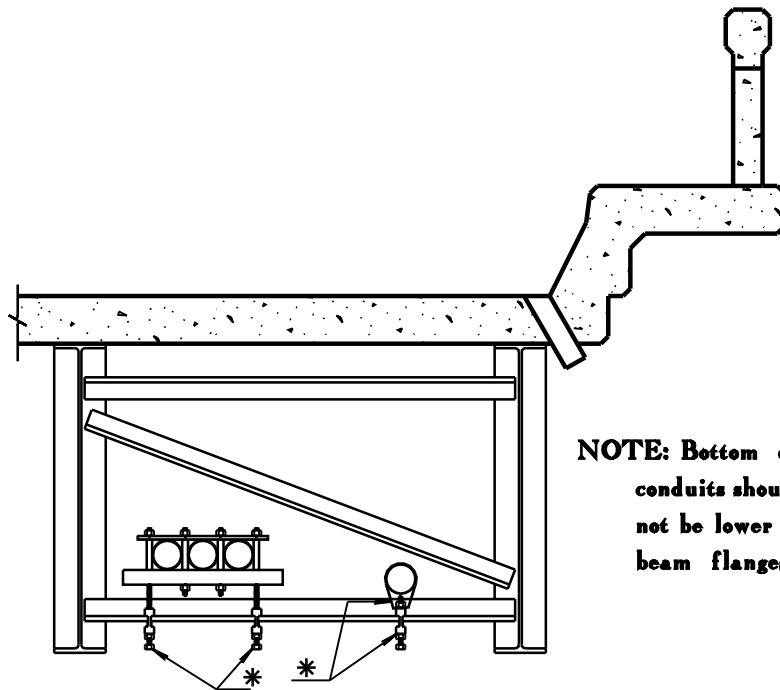

NOTE: Bottom of conduits should not be lower than beam flanges

**SINGLE OR MULTIPLE CONDUITS
- PREFERRED LOCATION -**

(See additional sheet for - ALTERNATE LOCATION -)

* Drilling, welding, or cutting of any structural steel is not allowed.
Use Conduit or Beam Clamps in place of drilling or cutting.

NOTE: All steel materials used in attaching a utility to a structure must be stainless or galvanized.

Plot Date : 5/9/2007

View = Plot2

Plotted By : ronads

Plot File : \\A\Bridge Inspection\B\School\Bridg Insp Manuals\Utility Attachments\ulbr man.dgn

KANSAS DEPARTMENT OF TRANSPORTATION

UTILITY ATTACHMENT PLACEMENT

For Concrete Beam Type Superstructures

Support Spacing
_____ meters
(_____)feet

Diameter Conduit(s)
_____ mm
(_____)inches

Weight (Includes Conduit,
Support System and Cables)
_____ kg/ m
(_____)lbs./ ft.

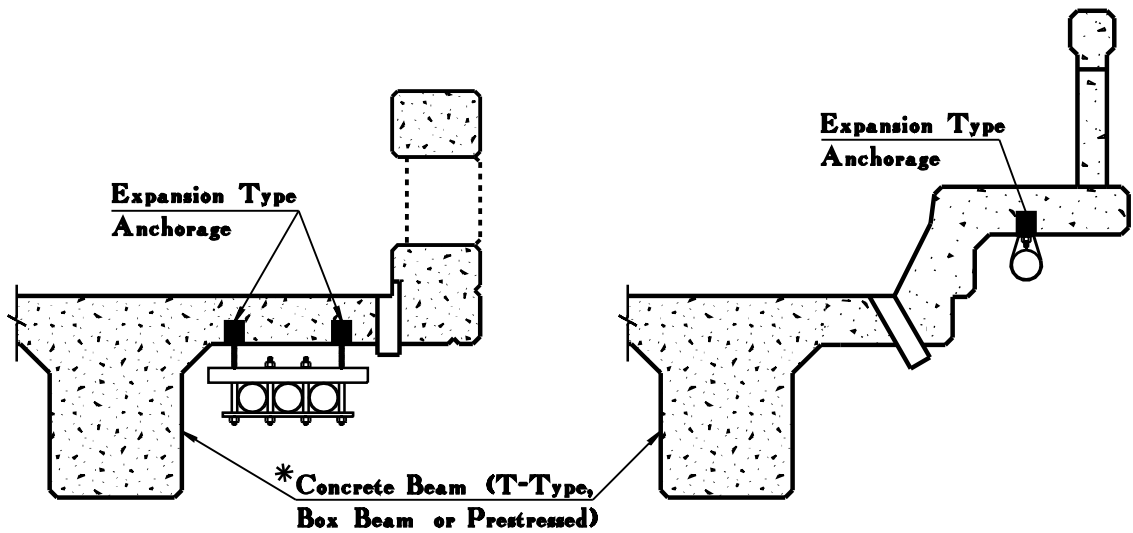

With Corral Rail or
New Jersey Barrier

With Parapet Rail

*** NOTE: ATTACHMENT ANYWHERE TO THE CONCRETE SUPERSTRUCTURE (BEAM) WILL NOT BE ALLOWED.**

**SINGLE OR MULTIPLE CONDUIT
- ATTACHMENT LOCATION ON CONCRETE BEAM BRIDGES -**

NOTE: All steel materials used in attaching a utility to a structure must be stainless or galvanized.

Plot Date : 5/9/2007

View= Plot3

Plotted By : ronalds

Plot File : \\A\Bridge Inspection\B\School\Bridg Insp Manuals\Utility Attachments\ulbr man.dgn

KANSAS DEPARTMENT OF TRANSPORTATION

UTILITY ATTACHMENT PLACEMENT

For a Concrete Slab Type Superstructure

Support Spacing
_____ meters
(_____)feet

Diameter Conduit(s)
_____ mm
(_____)inches

Weight (Includes Conduit,
Support System and Cables)
_____ kg/ m
(_____)lbs./ ft.

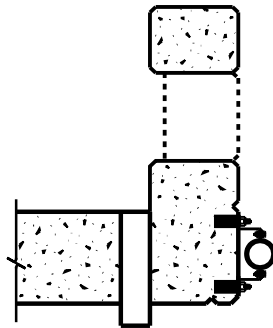

With Corral Rail or
New Jersey Barrier

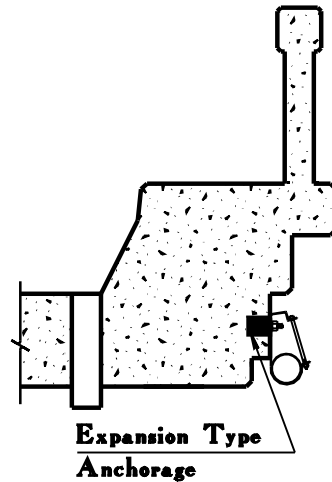

With Parapet Rail

SINGLE CONDUIT - LOCATIONS -

NOTE: All steel materials used in attaching a utility to a structure must be stainless or galvanized.

KANSAS DEPARTMENT OF TRANSPORTATION

SOME ACCEPTABLE HANGER & CLAMP TYPES

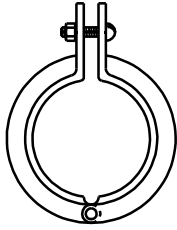

**SPLIT RING
HANGER**

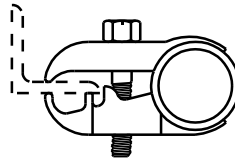

**PARALLEL PIPE AND
CONDUIT CLAMP**

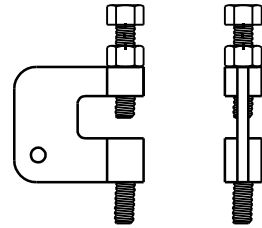

**"C" CLAMP
WITH LOCKNUT**

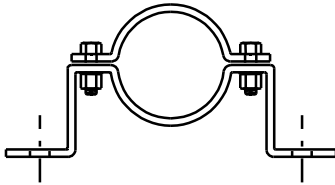

**OFFSET
PIPE CLAMP**

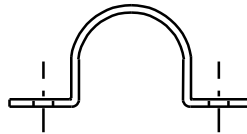

**HOLD DOWN
PIPE CLAMP**

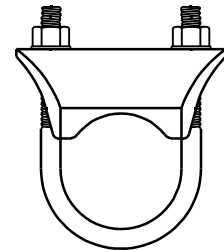

**RIGHT ANGLE
PIPE CLAMP**

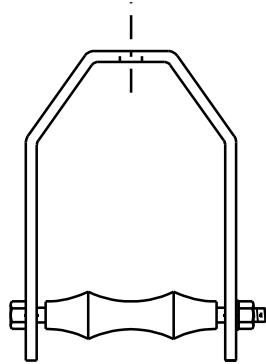

PIPE ROLLER HANGER

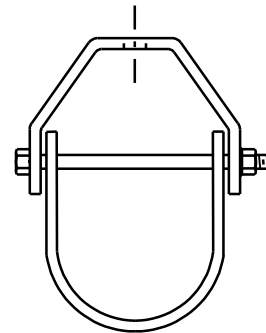

CLEVIS HANGER

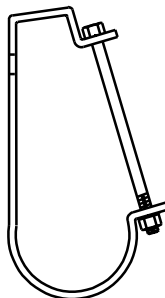

T-SLOT HANGER

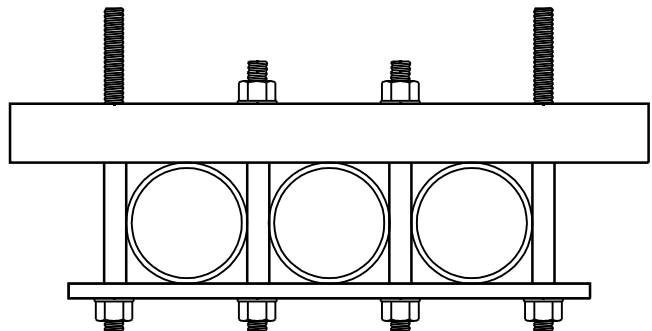

DUCT SUPPORT SYSTEM

Plot Date : 5/9/2007

View= Plot4

Plotted By : ronads

Plot File : \\A\Bridges\Inspection\B\School\Bridges\Insp Manuals\Utility Attachments\ulbr man.dgn

STATE	PROJECT NO.	YEAR	SHEET NO.	TOTAL SHEETS
KANSAS				

1. MUTCD COMPLIANCE:

ALL TEMPORARY TRAFFIC CONTROL DEVICES AND THEIR INSTALLATION AND MAINTENANCE SHALL COMPLY WITH THE LATEST EDITION OF THE MANUAL ON UNIFORM TRAFFIC CONTROL DEVICES (MUTCD) FOR STREETS AND HIGHWAYS WHICH HAS BEEN ADOPTED BY THE SECRETARY OF TRANSPORTATION. WHENEVER THE TEMPORARY TRAFFIC CONTROL STANDARDS CONFLICT WITH THE MUTCD, THE STANDARDS SHALL GOVERN.

2. DESIGN SPEED:

THOSE ITEMS DELEGATED TO TEMPORARY TRAFFIC CONTROL SHOULD BE DESIGNED AND INSTALLED USING THE POSTED/LEGAL SPEED OF THE ROADWAY PRIOR TO WORK STARTING.

3. CLEAR ZONE:

ALL CONSTRUCTION EQUIPMENT (INCLUDING VEHICLES), MATERIALS, AND DEBRIS SHALL BE STORED OUT OF THE CLEAR ZONE. WHERE THIS CANNOT BE ACHIEVED, THE CONTRACTOR SHALL PLACE APPROPRIATE SIGNS, OBJECT IDENTIFIERS, AND/OR BARRICADES AS DESIGNATED BY THE ENGINEER. TEMPORARY TRAFFIC CONTROL DEVICES NEEDED FOR THIS CONDITION SHALL BE CONSIDERED SUBSIDIARY TO OTHER BID ITEMS.

4. MINIMUM LANE WIDTHS:

LANE WIDTHS SHALL BE A MINIMUM OF 11' (MEASURED BETWEEN CENTERLINES OF PAVEMENT MARKINGS) OR AS SHOWN ON THE PLANS, OR AS DIRECTED BY THE ENGINEER. A LANE WIDTH LESS THAN 11' MAY REQUIRE RESTRICTED ROADWAY WIDTH SIGNING.

5. FLAGGER:

A MINIMUM OF ONE FLAGGER SHALL BE STATIONED WITHIN EACH MULTI-LANE ROADWAY ACTIVITY AREA WHERE WORK IS IN A CLOSED LANE ADJACENT TO TRAFFIC AND NOT SEPARATED BY A CONCRETE SAFETY BARRIER SYSTEM.

6. PAVEMENT MARKING:

WHEN THE WORK WILL OCCUPY A LOCATION MORE THAN THREE (3) DAYS, ALL CONFLICTING PAVEMENT MARKINGS SHALL BE REMOVED OR MASKED AND ALL TRANSITION TAPERS, CROSSOVERS, AND EDGE LINES ALONG CHANNELIZING DEVICES SHALL BE MARKED WITH SOLID 4" WIDE PAVEMENT MARKING.

7. FIRST MODULE OF IBS:

THE FIRST MODULE OF EACH INERTIAL BARRIER SYSTEM (IBS) SHALL HAVE A MINIMUM OF 2 SQ. FT. OF FLUORESCENT ORANGE PRISMATIC GRADE RETROREFLECTIVE SHEETING FACING TRAFFIC. EITHER A VERTICAL RECTANGLE OR DIAMOND SHAPE MAY BE USED.

8. PEDESTRIAN / BICYCLE SAFETY:

WORK ZONE SIGNS SHALL NOT INHIBIT PEDESTRIAN AND BICYCLE TRAFFIC ON SIDEWALKS OR OTHER AREAS DESIGNATED FOR PEDESTRIAN OR BICYCLE USE. CONSIDERATION SHOULD BE MADE TO SEPARATE PEDESTRIAN AND BICYCLE MOVEMENTS FROM BOTH WORK SITE ACTIVITY AND VEHICULAR TRAFFIC. UNLESS A REASONABLE SAFE ROUTE THAT DOES NOT INVOLVE CROSSING THE ROADWAY CAN BE PROVIDED, PEDESTRIANS AND BICYCLISTS SHOULD BE APPROPRIATELY DIRECTED WITH ADVANCE SIGNING THAT ENCOURAGES THEM TO CROSS TO THE OPPOSITE SIDE OF THE ROADWAY. IN URBAN AND SUBURBAN AREAS WITH HIGH VEHICULAR TRAFFIC VOLUMES, THESE SIGNS SHOULD BE PLACED AT INTERSECTIONS (RATHER THAN MIDBLOCK LOCATIONS) SO THAT PEDESTRIANS AND BICYCLISTS ARE NOT CONFRONTED WITH MIDBLOCK WORK SITES THAT WILL INDUCE THEM TO ATTEMPT SKIRTING THE WORK SITE OR MAKING A MIDBLOCK CROSSING.

WHEN EXISTING PEDESTRIAN FACILITIES ARE DISRUPTED, CLOSED, OR RELOCATED, THE TEMPORARY FACILITIES SHALL BE DETECTABLE AND INCLUDE ACCESSIBILITY FEATURES CONSISTENT WITH THE FEATURES PRESENT IN THE EXISTING PEDESTRIAN FACILITY.

9. CHANGED STOP CONDITIONS:

ATTACH TWO FLAGS AND A RED TYPE "B" HIGH INTENSITY WARNING LIGHT TO ANY STOP SIGN THAT CREATES A NEW STOP CONDITION OR MOVES THE STOP CONDITION TO A NEW LOCATION. LEAVE FLAGS AND LIGHTS IN PLACE FOR AT LEAST THE FIRST 30 DAYS. INSTALL W3-1 (SYMBOLIC STOP AHEAD) SIGN IN ADVANCE OF STOP SIGN IF STOP SIGN IS NOT VISIBLE FOR A MINIMUM OF DISTANCE 'A' (SEE CHART ON TE710) OR IF STOP CONDITION IS MOVED TO LESS THAN DISTANCE 'A' FROM AN EXISTING STOP AHEAD SIGN.

10. LUMP SUM BIDDING:

WHEN TRAFFIC CONTROL IS BID LUMP SUM, ADDITIONAL DEVICES WILL BE PAID FOR AS EXTRA WORK.

11. NIGHTTIME LIGHTING:

WHEN NIGHTTIME WORK IS REQUIRED, FLOODLIGHTS SHOULD BE USED TO ILLUMINATE FLAGGER STATIONS, EQUIPMENT CROSSINGS, AND OTHER AREAS WHERE EXISTING LIGHTING IS NOT ADEQUATE FOR THE WORK TO BE PERFORMED SAFELY.

IN NO CASE SHALL FLOODLIGHTS BE PERMITTED TO CREATE A DISABLING GLARE FOR THE DRIVER. THE ADEQUACY OF THE FLOODLIGHT PLACEMENT AND ELIMINATION OF POTENTIAL GLARE SHOULD BE CHECKED BY DRIVING THROUGH THE PROJECT.

12. NCHRP REPORT 350 CRASHWORTHY REQUIREMENTS:

TRAFFIC CONTROL DEVICES SHALL MEET THE EVALUATION CRITERIA IN NCHRP REPORT 350 AS SUPPLEMENTED BY FHWA MEMORANDUM "IDENTIFYING ACCEPTABLE HIGHWAY SAFETY FEATURES," DATED JULY 25, 1997. AVAILABLE ON THE INTERNET AT http://safety.fhwa.dot.gov/roadway_dept/road_hardware/nchrp_350.htm

ANY DEVICE NOT ADDRESSED BY THE TE STANDARDS MAY BE APPROVED ON A CASE BY CASE BASIS BY THE ENGINEER. THE DEVICE SHALL BE ACCOMPANIED BY AND INSTALLED ACCORDING TO NCHRP REPORT 350.

THE CONTRACTOR SHALL:

1) PROVIDE TO THE ENGINEER A COPY OF THE MANUFACTURER'S SELF-CERTIFICATION THAT ANY CATEGORY 1 (i.e. - PLASTIC CONICAL DELINEATORS, TUBULAR MARKERS, DRUMS WITHOUT ATTACHMENTS) AND CATEGORY 2 (i.e. - PORTABLE SIGN STANDS (WITH SIGNS), TYPE II AND III BARRICADES, AND VERTICAL PANELS) DEVICES USED ON THE PROJECT ARE NCHRP REPORT 350 COMPLIANT.

2) PROVIDE TO THE ENGINEER A COPY OF THE ENTIRE FHWA NCHRP REPORT 350 ACCEPTANCE LETTER (WZ-xxx) FOR ANY CATEGORY 2 DEVICE (i.e. - PORTABLE SIGN STANDS (WITH SIGNS), TYPE II AND III BARRICADES, AND VERTICAL PANELS) USED ON THE PROJECT. WORK ZONE FHWA NCHRP REPORT 350 ACCEPTANCE LETTERS (WZ-xxx) ARE AVAILABLE ON THE INTERNET AT: http://safety.fhwa.dot.gov/roadway_dept/road_hardware/listing.cfm?code=workzone

3) CERTIFY THAT THE TRUCK MOUNTED ATTENUATORS (TMA'S) (WHICH ARE DEFINED AS CATEGORY 3 DEVICES BY THE FHWA MEMORANDUM) WERE PURCHASED PRIOR TO OCTOBER 1, 1998, AND INCLUDE A COPY OF THE ENTIRE FHWA ACCEPTANCE LETTER STATING THAT THE TMA'S ARE NCHRP REPORT 230 COMPLIANT; OR IF THE DEVICES WERE PURCHASED AFTER OCTOBER 1, 1998, INCLUDE A COPY OF THE ENTIRE FHWA'S ACCEPTANCE LETTER STATING THAT THE TMA'S ARE NCHRP REPORT 350 COMPLIANT. ALL CATEGORY 2 & 3 DEVICES SHALL BE PURCHASED PRIOR TO 50 MPH. TMA'S PURCHASED PRIOR TO OCTOBER 1, 1998, MAY BE USED UNTIL THE END OF THEIR SERVICEABLE LIVES.

13. TYPE "A" LOW INTENSITY WARNING LIGHTS:

A TYPE "A" LOW INTENSITY WARNING LIGHT IS AN L.E.D. BI-DIRECTIONAL FLASHING WORK ZONE WARNING LIGHT.

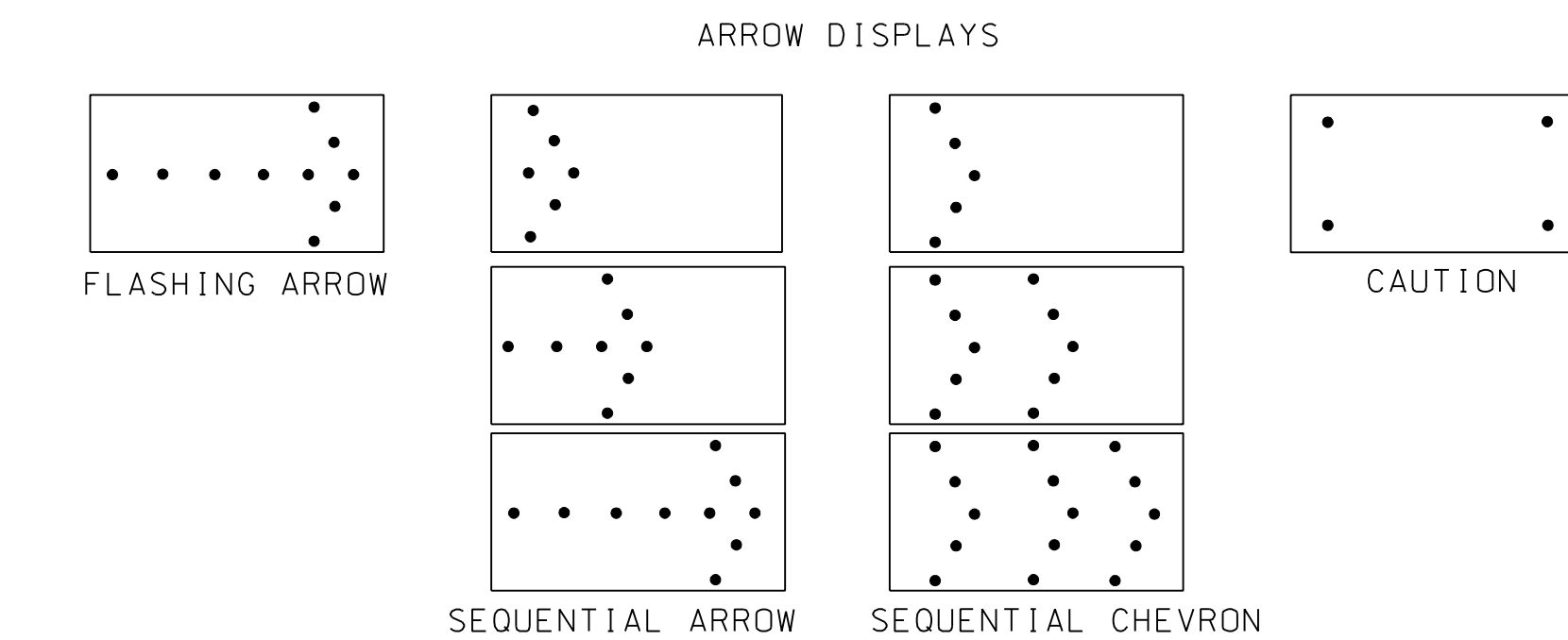

ARROW DISPLAY ELEMENTS SHALL BE CAPABLE OF A MINIMUM 50 PERCENT DIMMING FROM THEIR FULL-RATED LAMP VOLTAGE. FULL LAMP VOLTAGE SHOULD BE USED DURING THE DAY AND DIMMED MODE SHALL BE USED AT NIGHT. FOR SHOULDER WORK, ROADSIDE WORK NEAR THE SHOULDER, BLOCKING THE SHOULDER, OR FOR TEMPORARY CLOSING ONE LANE ON A TWO-LANE, TWO-WAY ROADWAY, AN ARROW PANEL SHALL BE USED ONLY IN THE CAUTION MODE.

BUFFER SPACE

SPEED (MPH) *	20	25	30	35	40	45	50	55	60	65	70
LENGTH (ft)	115	155	200	250	305	360	425	495	570	645	730

NEITHER WORK ACTIVITY NOR STORAGE OF EQUIPMENT, VEHICLES, OR MATERIAL SHOULD OCCUR IN THE BUFFER SPACE. WHEN A PROTECTION VEHICLE IS PLACED IN ADVANCE OF THE WORK SPACE, ONLY THE SPACE UPSTREAM OF THE VEHICLE CONSTITUTES THE BUFFER SPACE.

* POSTED SPEED PRIOR TO WORK STARTING

IF TEMPORARY CONCRETE SAFETY BARRIER SYSTEM IS USED TO SEPARATE APPROACHING TRAFFIC FROM THE WORK SPACE, THE BARRIER SYSTEM SHALL BE CONSIDERED PART OF THE ACTIVITY AREA. A FULL LANE WIDTH SHOULD BE AVAILABLE THROUGHOUT THE LENGTH OF THE BUFFER SPACE. SEE TYPICAL WORK ZONE COMPONENTS.

Void
Refer to Current TE Standard Revision
TE Standard available in KART

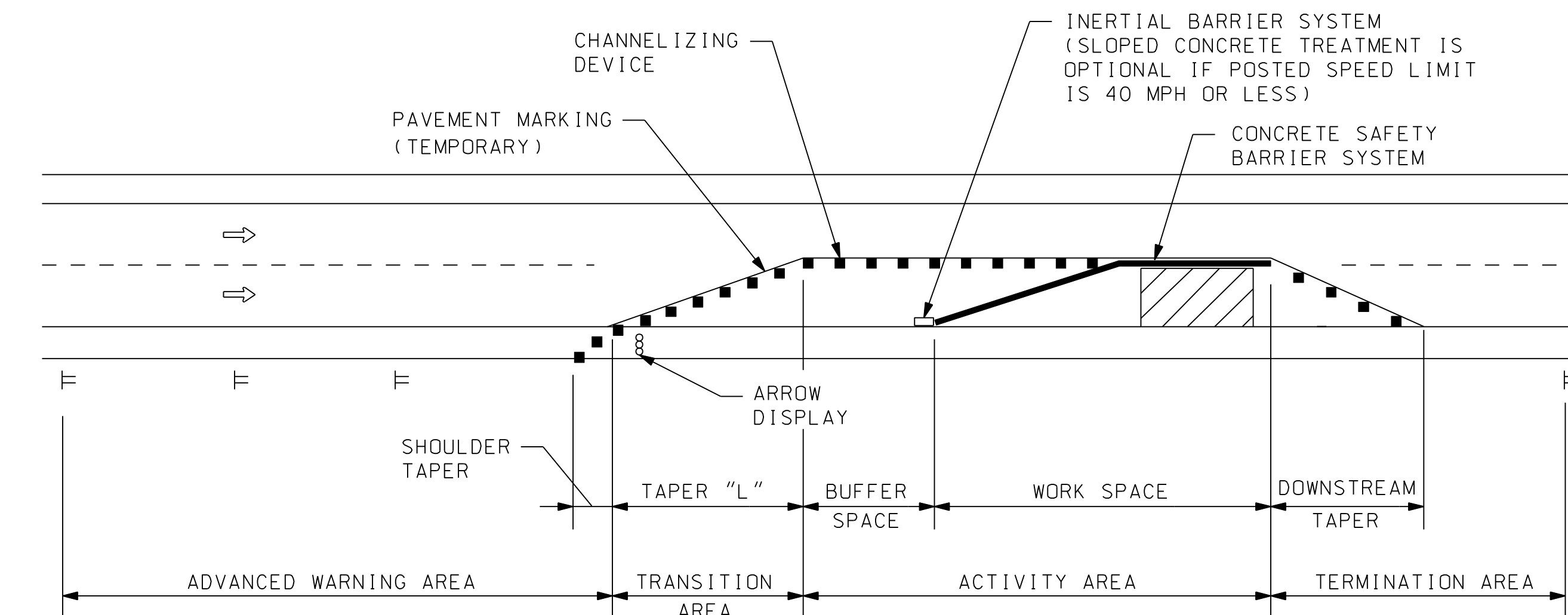

NOTE:
REFER TO STD. TE702 FOR
TAPER "L" FORMULA.

3	8-8-07	ADD NOTE 13, REVISE NOTE 8 & WZ COMPONENTS	M.B.	A.A.A.
2	12-29-05	MODIFIED BUFFER SPACE TABLE	M.B.	A.A.A.
1	2-1-05	MODIFIED NOTES *2, 8, 10	B.H.	A.A.A.
NO.	DATE	REVISIONS	BY	APP'D

KANSAS DEPARTMENT OF TRANSPORTATION
GENERAL TRAFFIC CONTROL

TE700		9/1/00	
FHWA APPROVAL	8-8-07	APP'D	Anthony A. Alrobalre
DESIGNED	B.A.H.	DETAILED	B.A.H.
DESIGN CR.	DETAIL CR.	QUANTITIES	TRACED
		QUAN. CR.	TRACE CR.

Plotted By : maybr
 Plot File : L:\TrafficControl\Working_Revisions\English_dgn\Ver000.dgn
 Plot Date : 8/14/2007

STATE	PROJECT NO.	YEAR	SHEET NO.	TOTAL SHEETS
KANSAS				

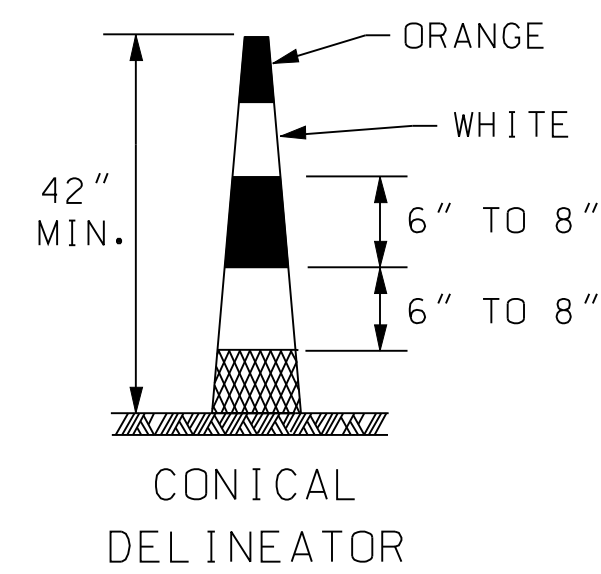
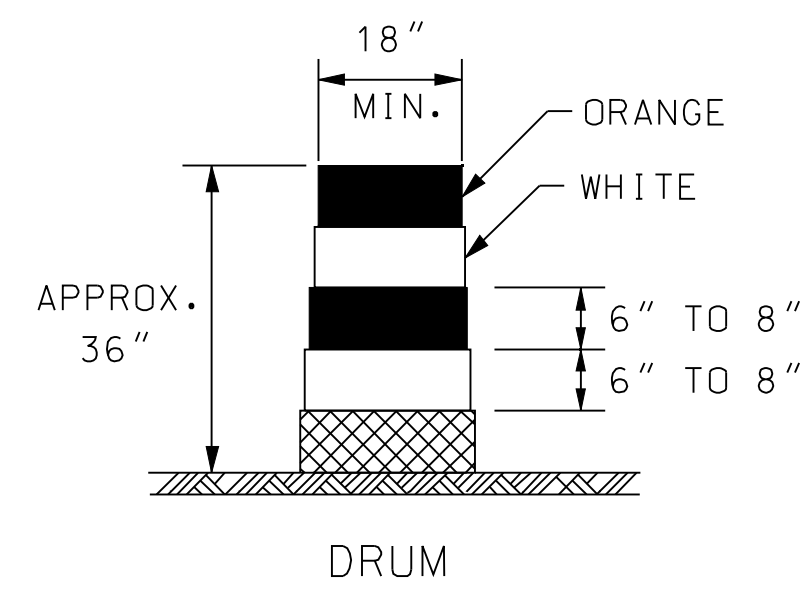

DRUMS AND CONICAL DELINEATORS SHALL HAVE AT LEAST TWO ORANGE AND TWO WHITE 6" TO 8" WIDE RETROREFLECTIVE STRIPES. ADDITIONAL STRIPES MAY BE NON-RETROREFLECTIVE. IF THERE ARE NON-RETROREFLECTIVE SPACES BETWEEN ADJACENT STRIPES, THEY SHALL BE NO MORE THAN 3" WIDE.

ALL RETROREFLECTIVE STRIPES ON DRUMS SHALL BE ASTM TYPE III SHEETING. THE WHITE STRIPES ON CONICAL DELINEATORS SHALL BE ASTM TYPE III SHEETING. ORANGE STRIPES ON ALL CONICAL DELINEATORS SHALL BE FLUORESCENT ORANGE ASTM TYPE IV SHEETING.

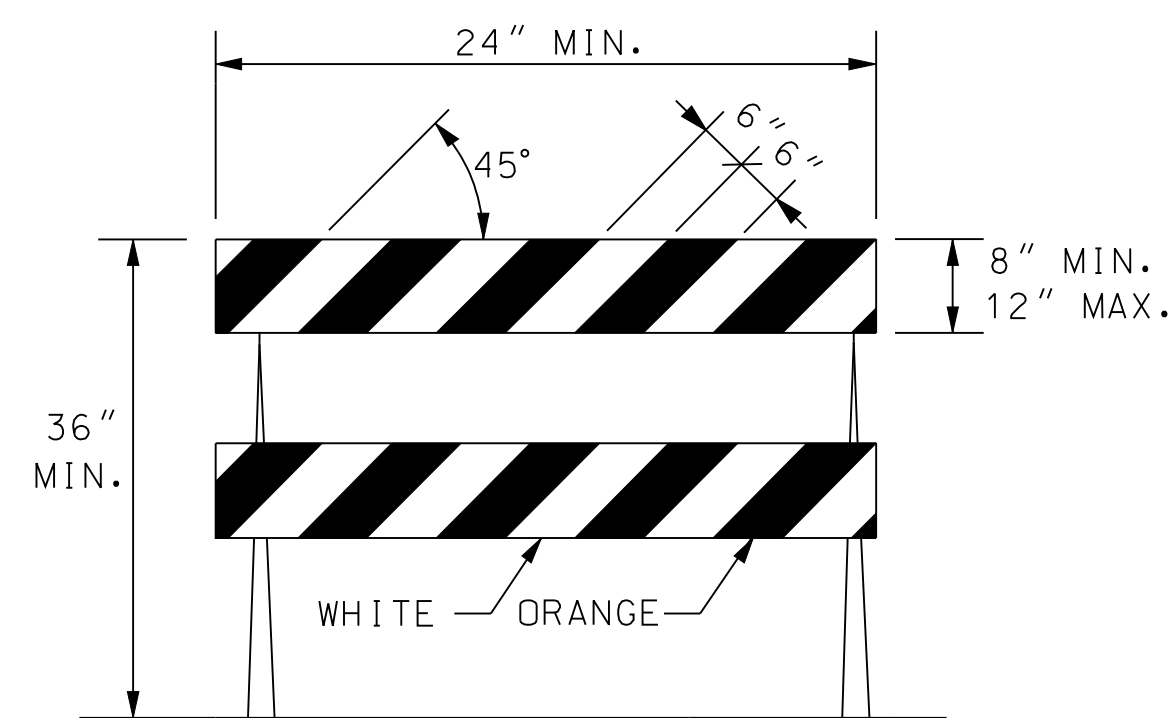

TYPE II BARRICADE

FOR RAILS LESS THAN 36" LONG, 4" WIDE STRIPES MAY BE USED.

THE ENTIRE AREA OF BARRICADE RAILS, BOTH FRONT AND BACK, SHALL BE ASTM TYPE III SHEETING.

THE STRIPES SHALL SLOPE DOWNWARD TO THE TRAFFIC SIDE FOR CHANNELIZATION.

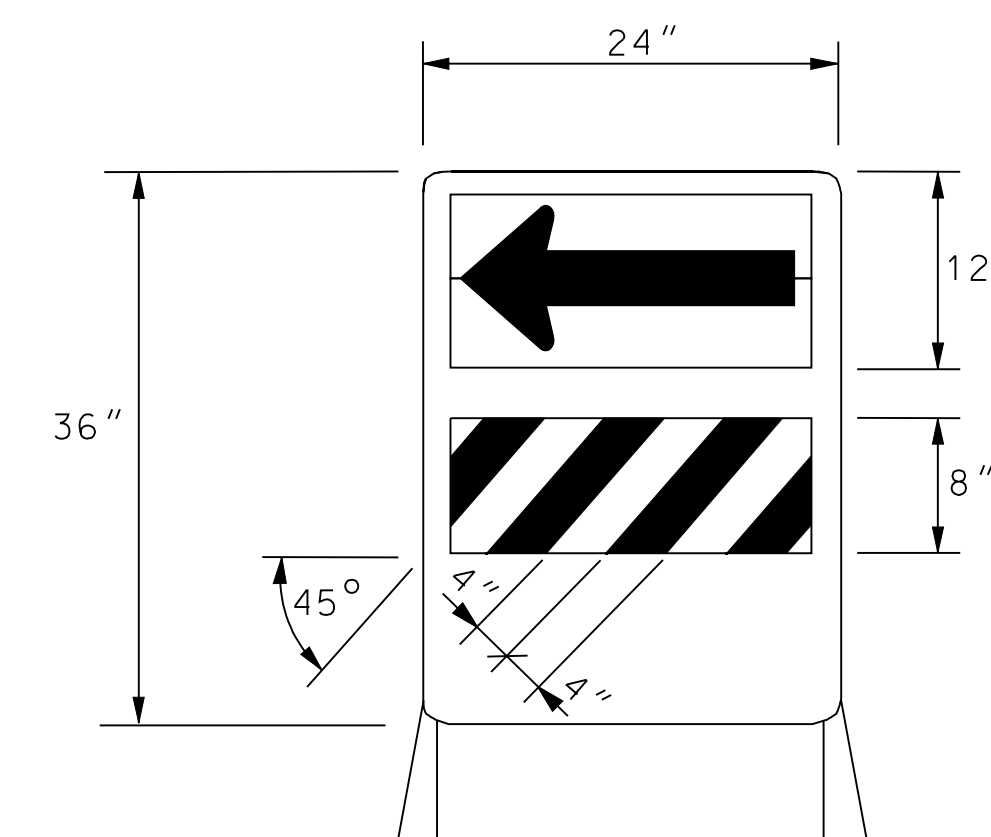

DIRECTION INDICATOR BARRICADE

THE ARROW PANEL SHALL BE BLACK ON FLUORESCENT ORANGE ASTM TYPE IV SHEETING. THE STRIPES SHALL BE ORANGE AND WHITE ASTM TYPE III SHEETING SLOPING DOWNWARD IN THE DIRECTION TRAFFIC IS TO PASS.

THE DIRECTION INDICATOR BARRICADE SHALL BE USED IN SERIES TO DIRECT THE MOTORIST INTO THE INTENDED LANE OF TRAVEL.

THE ARROW PANEL SHOULD NOT BE VISIBLE TO OPPOSING TRAFFIC.

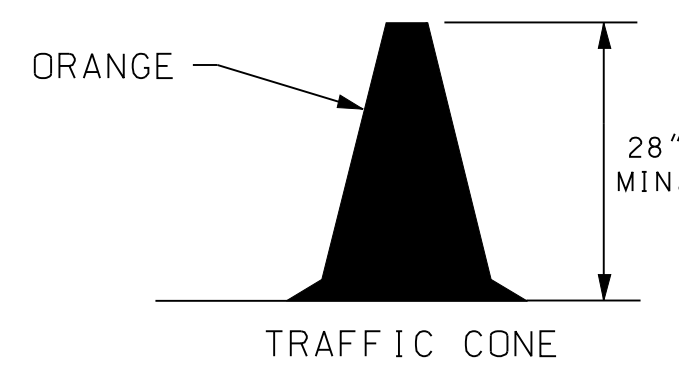

TRAFFIC CONE

TRAFFIC CONES MAY BE USED AS CHANNELIZING DEVICES FOR DAYTIME OPERATIONS AND LOW SPEED ROADWAYS ONLY. THEY WILL NOT BE PAID FOR SEPARATELY, BUT WILL BE SUBSIDIARY TO OTHER TRAFFIC CONTROL BIDDING ITEMS. THE ENGINEER MAY REQUIRE THAT TRAFFIC CONES BE SUPPLEMENTED BY OTHER TRAFFIC CONTROL DEVICES IN CERTAIN SITUATIONS.

Void Refer to Current TE Standard Revision TE Standard available in KART

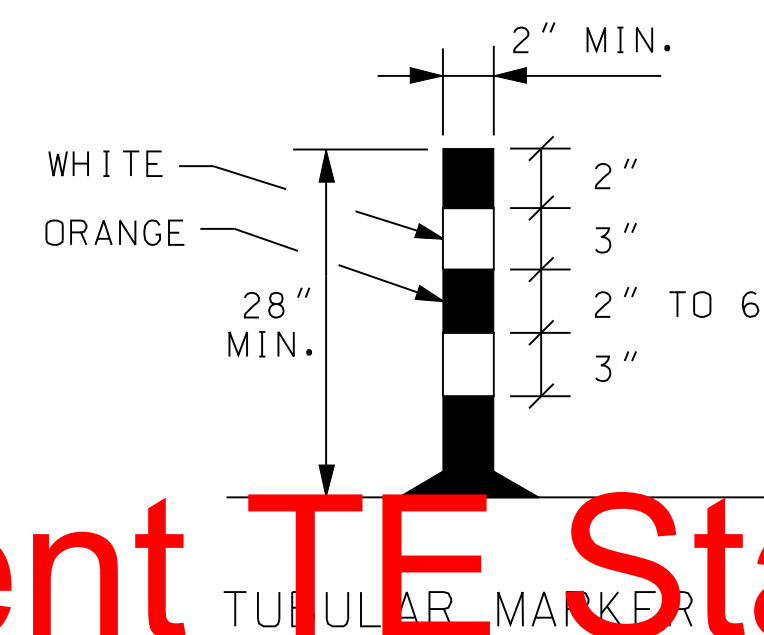

TUBULAR MARKER

THE TWO WHITE RETROREFLECTIVE STRIPES SHALL BE ASTM TYPE III SHEETING.

TAPER FORMULAS:

$L = WS$ FOR SPEEDS OF 45 MPH OR MORE

$L = WS^2/60$ FOR SPEEDS OF 40 MPH OR LESS

WHERE: L = MINIMUM LENGTH OF TAPER IN FEET
S = NUMERICAL VALUE OF POSTED SPEED
PRIOR TO WORK STARTING IN MPH
W = WIDTH OF OFFSET IN FEET

CHANNELIZER PLACEMENT:

(A) THE SPACING BETWEEN DEVICES IN THE ADVANCE WARNING AREA AND THE TRANSITION AREA (TAPER) SHOULD NOT EXCEED A DISTANCE IN FEET EQUAL TO THE POSTED SPEED LIMIT IN MPH PRIOR TO WORK STARTING.

(B) THE SPACING BETWEEN DEVICES IN THE ACTIVITY AREA SHOULD NOT EXCEED A DISTANCE IN FEET EQUAL TO TWO TIMES THE POSTED SPEED LIMIT IN MPH PRIOR TO WORK STARTING.

(C) CHANNELIZING DEVICES SHALL BE PLACED FOR OPTIMUM VISIBILITY, NORMALLY AT RIGHT ANGLES TO THE TRAFFIC FLOW.

(D) CHANNELIZING DEVICES PLACED ALONG SHOULDER EDGES OR IN DROPOFFS SHALL HAVE A MINIMUM OF 24" FROM THE TOP OF THE CHANNELIZING DEVICE TO THE TOP OF THE PAVEMENT.

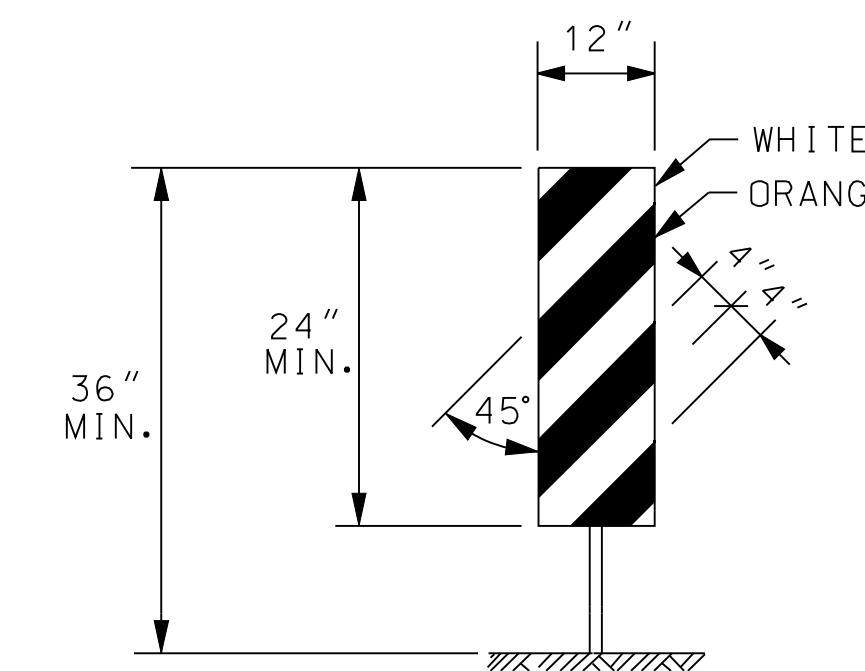

VERTICAL PANEL

THE ENTIRE AREA OF VERTICAL PANELS, BOTH FRONT AND BACK, SHALL HAVE ASTM TYPE III SHEETING. THE STRIPES SHALL SLOPE DOWNWARD TO THE TRAFFIC SIDE FOR CHANNELIZATION.

ITEM	LOCATION	LOCATION							OBJECT IDENTIFIER
		CROSS-OVERS	SHOULDER DIVERSIONS	TANGENTS	TAPERS	RAMPS	HEAD TO HEAD	OBJECT IDENTIFIER	
PORTABLE	DRUMS	YES	YES	YES	YES	YES	(1)	YES	
	CONICAL DELINEATORS	YES	YES	YES	YES	YES	(1)	YES	
	VERTICAL PANELS	(2)	(2)	(2)	(2)	(2)	(1,2)	YES	
	DIRECTION INDICATOR BARRICADE	NO	NO	NO	YES	NO	NO	NO	
	TYPE II BARRICADE	(2)	(2)	(2)	(2)	NO	NO	YES	
FIXED	TUBULAR MARKERS	(3)	(3)	(3)	NO	(3)	YES	NO	
	VERTICAL PANELS	(3)	(3)	(3)	(3)	(3)	(3)	YES	

- (1) Not allowed on centerline delineation along freeways or expressways.
- (2) The stripes shall slope downward to the traffic side for channelization.
- (3) May be used upon the approval of the Engineer.

3	8-8-07	TRIMLINE CHANGED TO CONICAL DELINEATOR	M.B.	A.A.A.
2	11-19-03	CHANGED BORDER	B.H.	S.A.B.
1	9-26-02	MODIFIED NOTES	M.H.	S.A.B.
NO.	DATE	REVISIONS	BY	APP'D

KANSAS DEPARTMENT OF TRANSPORTATION

CHANNELIZING DEVICES

TE702 9/1/00

DESIGNED	L.E.R.	APP'D	Anthony A. Alrobalre
DESIGN CK.	DETAIL CK.	QUANTITIES	TRACED
		QUAN. CK.	TRACE CK.

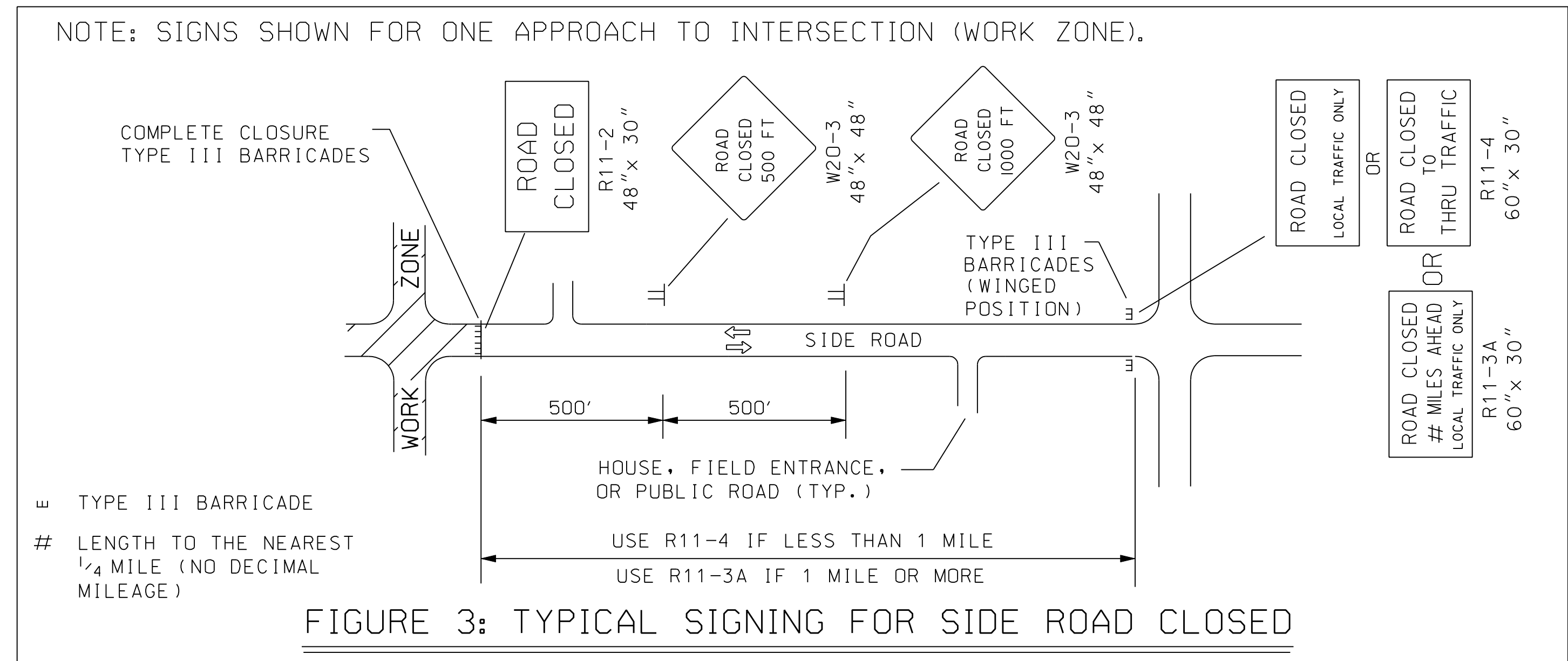
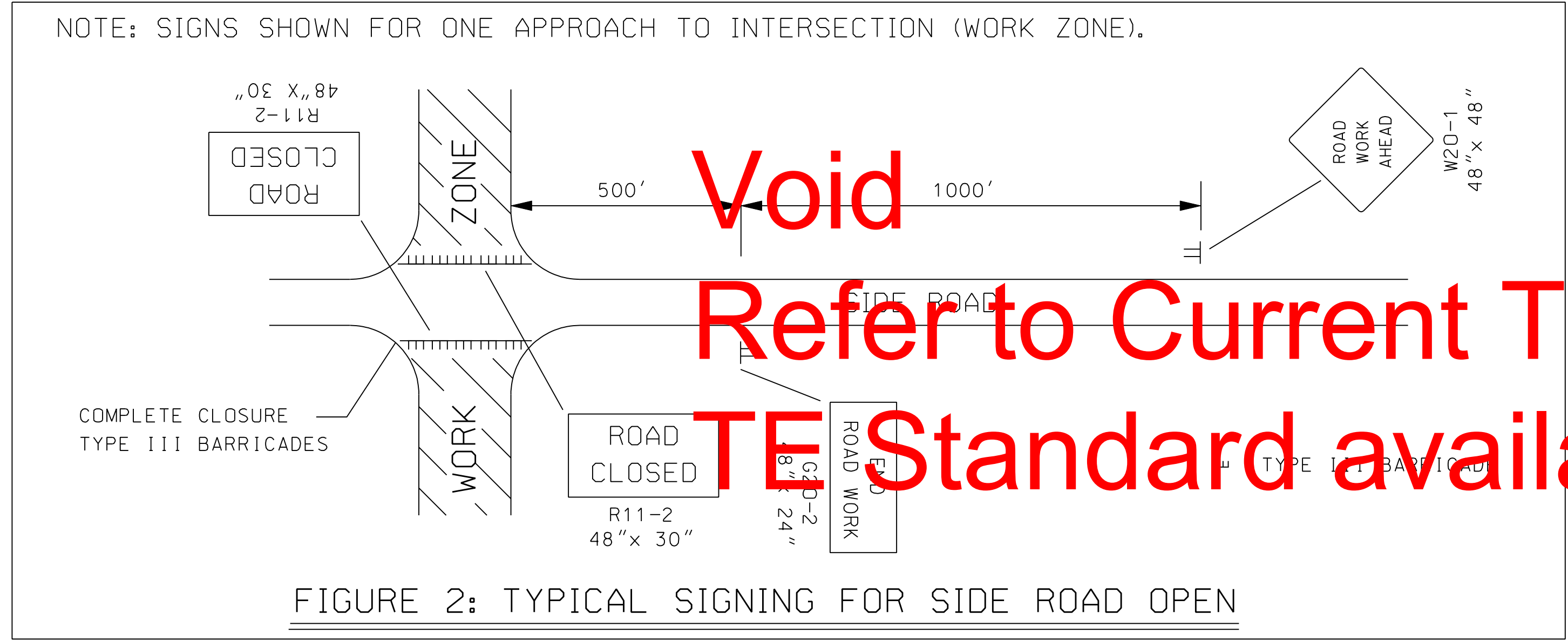
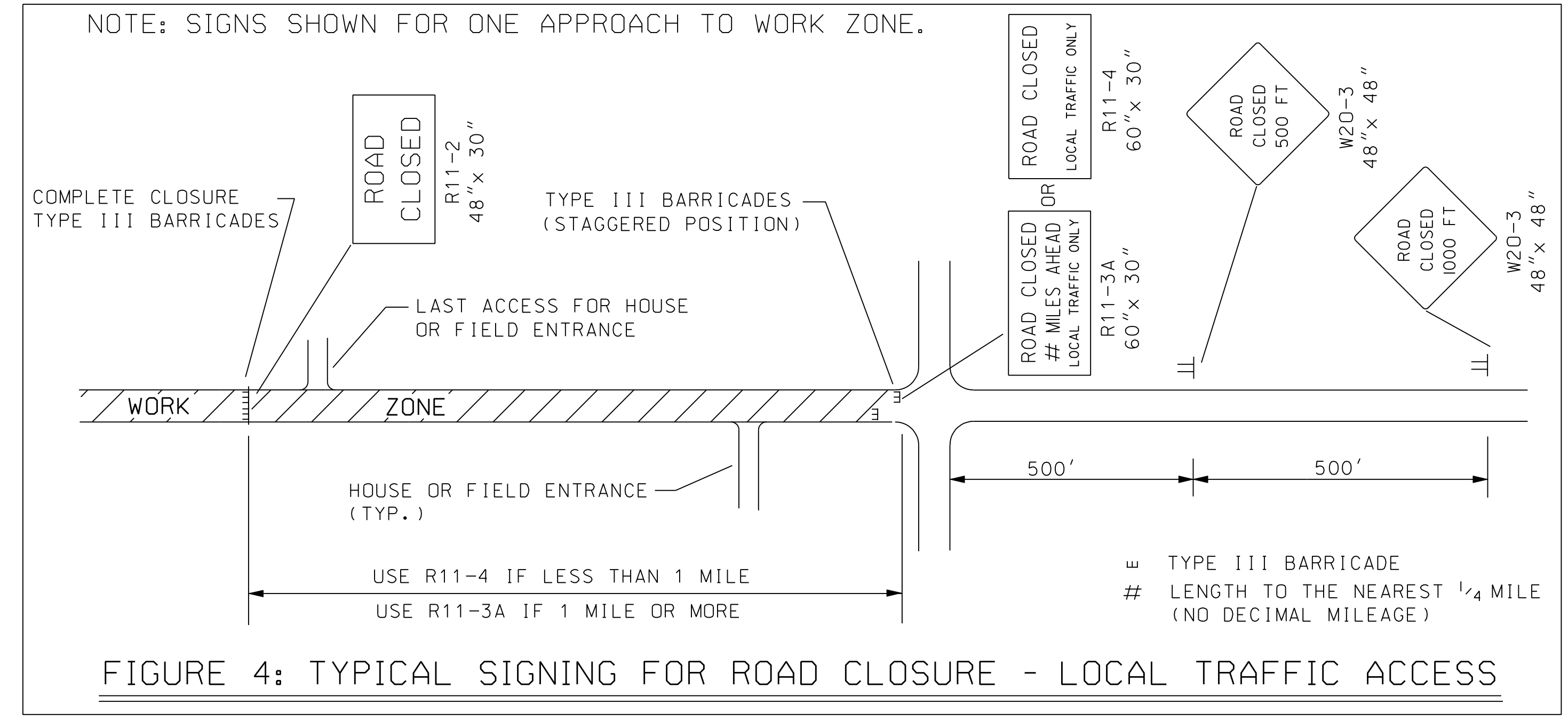
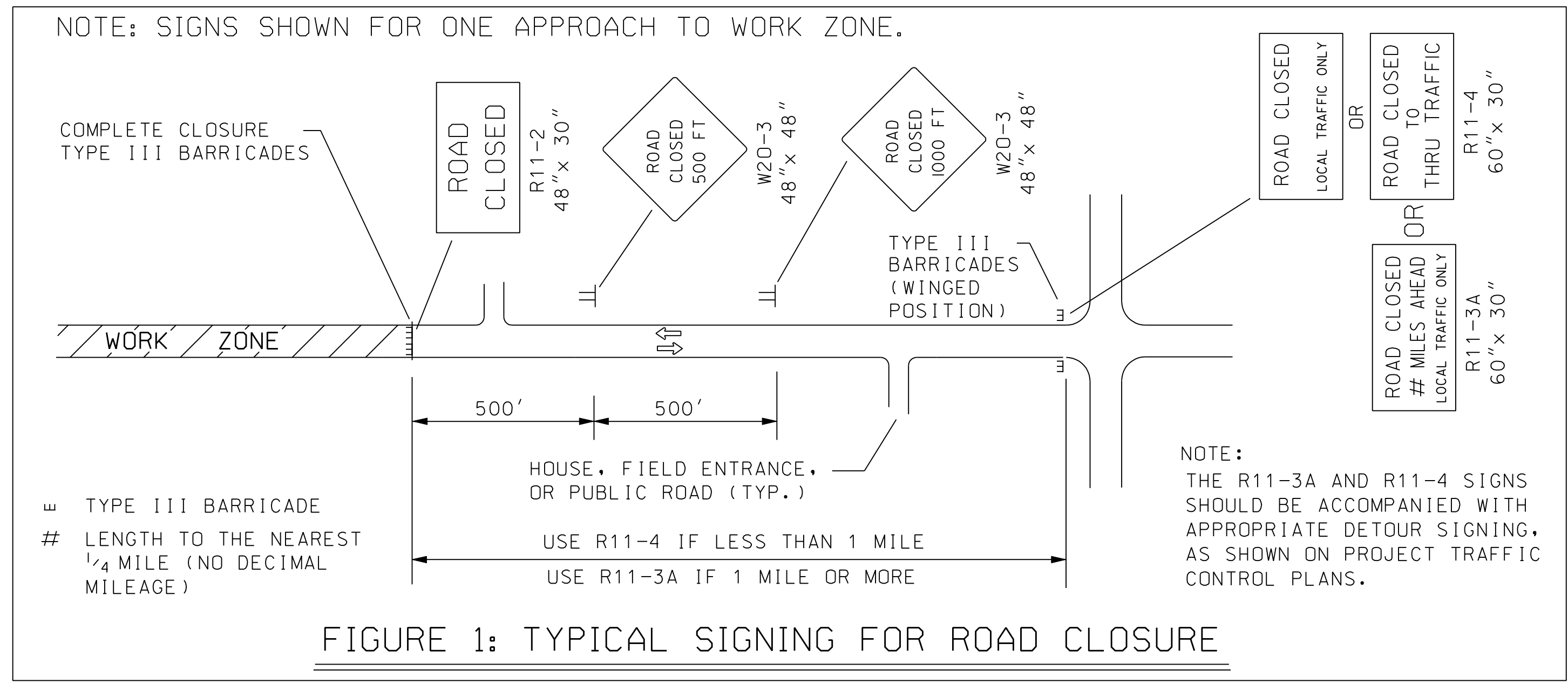

NOTES:

1. SIGNS:

THE R11-4 (ROAD CLOSED TO THRU TRAFFIC OR ROAD CLOSED LOCAL TRAFFIC ONLY) SIGN SHALL BE USED WHEN THE DISTANCE TO THE POINT OF COMPLETE CLOSURE OF THE ROADWAY IS LESS THAN 1 MILE.

THE R11-3A (ROAD CLOSED # MILES AHEAD LOCAL TRAFFIC ONLY) SIGN SHALL BE USED WHEN THE DISTANCE TO THE POINT OF COMPLETE CLOSURE OF THE ROADWAY IS 1 MILE OR GREATER.

THE WORDS "BRIDGE OUT" (OR BRIDGE CLOSED) MAY BE SUBSTITUTED FOR THE WORDS "ROAD CLOSED" ON THE R11-2 OR R11-4 SIGN WHERE APPLICABLE.

2. BARRICADE PLACEMENT:

A) COMPLETE ROAD CLOSURE

WHEN A ROADWAY IS CLOSED, TYPE III BARRICADES SHALL BE PLACED END-TO-END TO COMPLETELY COVER THE ROADWAY AND SHOULDERS. WHEN ACCESS MUST BE ALLOWED FOR CONSTRUCTION OR OTHER OFFICIAL/GOVERNMENT VEHICLES, TYPE III BARRICADES SHALL BE LONGITUDINALLY STAGGERED FAR ENOUGH APART FROM ONE ANOTHER TO ALLOW SAFE PASSAGE OF VEHICLES AND MAINTAIN THE APPEARANCE OF A CLOSED ROADWAY. TYPE III BARRICADES SHALL BE REALIGNED AND PLACED END-TO-END TO DENY ANY ACCESS WHEN THE CONSTRUCTION ACTIVITY HAS CEASED FOR THE DAY.

B) ROAD CLOSED - LOCAL TRAFFIC

AS SHOWN IN FIGURE 4, WHEN LOCAL TRAFFIC MUST BE ALLOWED ACCESS INTO THE WORK ZONE, TYPE III BARRICADES SHALL BE LONGITUDINALLY STAGGERED TO MAINTAIN THE APPEARANCE OF A CLOSED ROADWAY. A SECOND LINE OF END-TO-END TYPE III BARRICADES SHALL BE PLACED JUST BEYOND THE LAST ACCESS POINT IN THE WORK ZONE, TO COMPLETELY CLOSE THE ROADWAY AS DESCRIBED IN NOTE 2-A.

AS SHOWN IN FIGURE 1 AND FIGURE 3, AT THE POINT WHERE THRU TRAFFIC MUST DETOUR AND LOCAL TRAFFIC CAN PROCEED TO THE LOCATION WHERE THE ROADWAY IS COMPLETELY CLOSED, THE R11-3A (ROAD CLOSED # MILES AHEAD LOCAL TRAFFIC ONLY) OR R11-4 (ROAD CLOSED LOCAL TRAFFIC ONLY OR ROAD CLOSED TO THRU TRAFFIC) SIGN SHALL BE USED WITH TYPE III BARRICADES (WINGED POSITION), PLACED ON THE SHOULDERS OF ROADWAY.

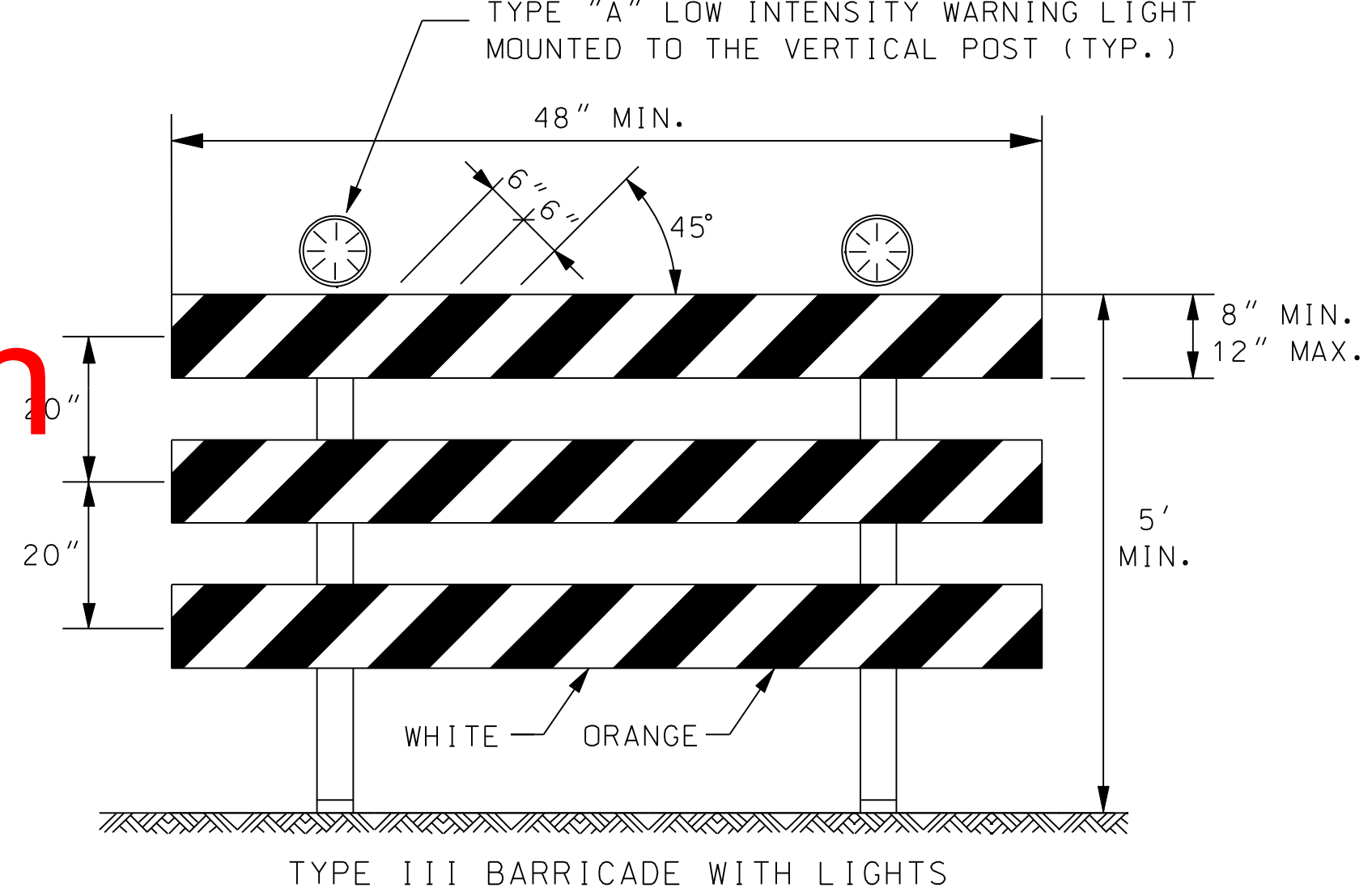

THE ENTIRE AREA OF BARRICADE RAILS, BOTH FRONT AND BACK, SHALL HAVE ASTM TYPE III SHEETING.

THE STRIPES SHALL SLOPE DOWNWARD TO THE SIDE TRAFFIC IS TO PROCEED OR TOWARD THE CENTER OF THE ROADWAY AT ROAD CLOSURES.

APPROVED SIGNS MOUNTED ON TYPE III BARRICADES SHOULD NOT COVER MORE THAN 50% OF THE TOP TWO RAILS OR 33% OF THE TOTAL AREA OF THE THREE RAILS.

WHEN BARRICADES ARE PLACED END-TO-END OR STAGGERED, A TYPE "A" LOW INTENSITY WARNING LIGHT SHALL BE MOUNTED TO THE VERTICAL POST NEAR EACH OUTSIDE CORNER OF THE END BARRICADES.

TYPE "A" LOW INTENSITY WARNING LIGHTS SHALL BE MAINTAINED SO AS TO BE VISIBLE ON A CLEAR NIGHT FROM A DISTANCE OF 3000'.

NO.	DATE	REVISIONS	BY	APP'D
3	8-8-07	ADDED POSITION TO TYPE III BARRICADES	M.B.	A.A.A.
2	12-29-05	MODIFIED NOTE #1	M.B.	A.A.A.
1	2-1-05	MODIFIED NOTES TYPE III BARRICADES WITH LIGHTS	B.H.	A.A.A.

KANSAS DEPARTMENT OF TRANSPORTATION

TYPICAL TRAFFIC CONTROL ROAD CLOSURES

TE704 9/26/02

FHWA APPROVAL	8-8-07	APP'D	Anthony A. Alrobaire
DESIGNED	B.A.H.	DETAILED	B.A.H.
DESIGN CK.	DETAIL CK.	QUANTITIES	QUAN. CK.
		TRACED	TRACE CK.

Void
Refer to Current TE Standard Revision
TE Standard available in KART

GENERAL NOTES

1. MAINTENANCE:

THE CONTRACTOR SHALL MAINTAIN ALL SIGNS AND DEVICES IN AN UPRIGHT POSITION. THE CONTRACTOR SHALL CLEAN OR REPLACE ANY DAMAGED OR ILLEGIBLE SIGN OR DEVICE AS DIRECTED BY THE ENGINEER.

2. EXISTING SIGNS:

IF EXISTING SIGNS THAT ARE TO REMAIN (WHETHER DENOED ON THE PLANS OR NOT) INTERFERE WITH CONSTRUCTION WORK, THE CONTRACTOR SHALL REMOVE, STORE, AND RESET THE SIGNS. THIS SHALL BE SUBSIDIARY TO OTHER TRAFFIC CONTROL BID ITEMS. SIGNING DAMAGED BY THE CONTRACTOR SHALL BE REPLACED AT THE CONTRACTOR'S EXPENSE.

3. CONFLICTING SIGNS, SIGNS NOT IN USE, AND TRAFFIC SIGNALS:

SIGNS AND TRAFFIC SIGNALS THAT ARE IN CONFLICT WITH THE TRAFFIC CONTROL PLAN OR DO NOT APPLY TO THE TRAFFIC OPERATIONS SHALL BE IMMEDIATELY REMOVED, TURNED SO NOT VISIBLE TO TRAFFIC FROM ANY DIRECTION, OR COMPLETELY COVERED WITH ADEQUATE OPAQUE WATERPROOF MATERIAL. TAPE SHALL NOT BE APPLIED TO THE FACE OF THE SIGN.

4. PORTABLE AND POST MOUNTED SIGNS:

TEMPORARY TRAFFIC CONTROL SIGNS THAT ARE ANTICIPATED TO REMAIN IN PLACE FOR 3 DAYS OR LESS ARE CONSIDERED "PORTABLE." PORTABLE SIGNS SHALL BE MOUNTED ON AN APPROVED SUPPORT AT A MINIMUM HEIGHT OF 12" ABOVE THE TRAVELED WAY. TRAFFIC CONTROL SIGNS IN PLACE FOR OVER 3 DAYS ARE REQUIRED TO BE MOUNTED ON APPROVED POSTS. A MINIMUM OF 42" OF THE APPROVED POST MUST BE BELOW THE GROUND SURFACE WITH ADEQUATE BACKFILL AND COMPACTION. ALL POSTS AT MINIMUM SHALL EXTEND TO THE TOP EDGE OF THE SIGN AND NO GREATER THAN 6" ABOVE THE SIGN.

WHEN THE SIGN WIDTH IS EQUAL TO OR GREATER THAN 9', THREE OR MORE WOOD POSTS MAY BE USED WITH A MINIMUM OF 4' BETWEEN THE CENTERLINE OF EACH POST. ALL SIGNS LESS THAN 9' IN WIDTH SHALL USE A MAXIMUM OF TWO WOOD POSTS.

"ROLL-UP" SIGNS MAY BE USED FOR PORTABLE WARNING SIGNS. THEY MUST BE FLUORESCENT ORANGE ASTM TYPE IV SIGNS OF OPAQUE MATERIAL. MESH SIGNS ARE NOT ALLOWED.

5. SHEETING:

ALL ORANGE SIGNS SHALL HAVE FLUORESCENT ORANGE ASTM TYPE IV SHEETING. ALL OTHER SIGNS SHALL HAVE ASTM TYPE III SHEETING OF STANDARD COLORS.

6. SIGNS INVOLVING SPEEDS:

THE W3-5 (SPEED REDUCTION) SHOULD BE USED ONLY IF THE ENGINEER DETERMINES THAT A REDUCED SPEED IS REQUIRED ON THE PROJECT.

THE KM4-20 (WORK ZONE) PLAQUE SHALL BE PLACED ABOVE ALL SPEED LIMIT SIGNS, (R2-1), EXISTING AND TEMPORARY. MOUNT THE WORK ZONE PLAQUES TO THE POST. DO NOT OVERLAP THE R2-1 AND KM4-20 SIGNS.

FOR SPEEDS OF 30 MPH OR LESS, THE W1-1(TURN) OR W1-3(REVERSE TURN) SHOULD BE USED. FOR SPEEDS OF 35 MPH OR MORE, THE W1-2(CURVE) OR W1-4(REVERSE CURVE) SHOULD BE USED. THE W13-1(MPH) IS TO BE ELIMINATED IF THE ADVISORY SPEED IS WITHIN 5 MPH OF THE SPEED LIMIT.

7. SIGNS CONTROLLING WORK ZONE:

THE KG20-2(END ROAD WORK) SHOULD BE PLACED 500' FROM THE END OF THE ACTUAL WORK SPACE, NOT NECESSARILY AT THE EXTREME LIMITS OF THE PROJECT. THE KG20-2 SHOULD BE MOUNTED ON TWO POSTS. THE KG20-2 MAY BE MOUNTED ON ONE POST IF IN URBAN AREAS WHERE UTILITIES ARE A PROBLEM AND WIND LOADS ARE NOT AN ISSUE.

WHERE TWO WORK ZONES ARE LESS THAN 1 MILE APART IN RURAL AREAS OR 1/4 MILE APART IN URBAN AREAS, THE KG20-2(END ROAD WORK) FOR THE FIRST WORK ZONE AND THE W20-1(ROAD WORK) FOR THE SECOND WORK ZONE SHOULD BE ELIMINATED.

8. WARNING LIGHTS ON SIGNS:

TYPE "A" LOW INTENSITY WARNING LIGHTS SHOULD BE USED WITH ALL CONSTRUCTION ACTION WARNING SIGNS AND SHALL NOT BE USED ON SIGNS MOUNTED LESS THAN 5' HIGH ON TEMPORARY SUPPORTS. ON ALL OTHER CONSTRUCTION WARNING SIGNS, TYPE "A" LOW INTENSITY WARNING LIGHTS ARE TO BE USED AS DIRECTED BY THE ENGINEER.

TYPE "A" LOW INTENSITY WARNING LIGHTS SHALL BE MAINTAINED SO AS TO BE CAPABLE OF BEING VISIBLE ON A CLEAR NIGHT FROM A DISTANCE OF 3000 FT. IF A TYPE "A" LOW INTENSITY WARNING LIGHT HAS A SEPARATE BATTERY CASE, THE BATTERY CASE SHALL BE MOUNTED NO HIGHER THAN 12" ABOVE THE GROUND AND MOUNTED BEHIND THE SIGN POST. A TYPE "A" LOW INTENSITY WARNING LIGHT WHERE THE LENS AND BATTERY ARE ONE UNIT SHALL BE MOUNTED ON THE TEMPORARY SIGN POST NEAREST TO THE TRAVELED WAY. FLAGS SHALL NOT INTERFERE WITH THE VISABILITY OF THE TYPE "A" LOW INTENSITY WARNING LIGHT.

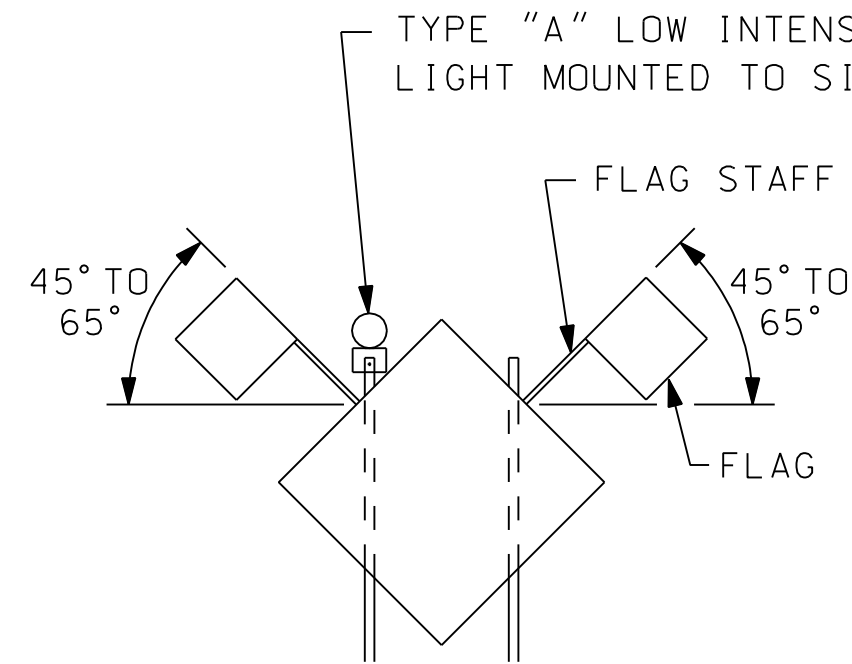

TWO (2) 18" x 18" FLUORESCENT RED-ORANGE FLAGS SHALL BE ATTACHED (IN THE POSITION SHOWN) ON THE W20-2(DETOUR), W1-1(TURN), W1-2(CURVE), W1-3(REVERSE TURN), W1-4(REVERSE CURVE), W3-3(SIGNAL AHEAD), W4-2(LANE REDUCTION), W20-4(ONE LANE ROAD), W20-5(LANE CLOSED), W20-7A(FLAGGER), AND W3-4 (BE PREPARED TO STOP) SIGNS AND ANY OTHER ACTION SIGNS AS SHOWN ON THE PLANS OR DIRECTED BY THE ENGINEER. THE FLAGS AND STAFFS ARE TO BE ATTACHED IN SUCH A MANNER THAT THE SIGN WILL NOT BE OBSCURED. THE FLAGS MAY BE EITHER A CLOTH OR VINYL MATERIAL. THE FLAGS SHALL BE SUBSIDIARY TO THE CONSTRUCTION SIGN BID ITEMS.

Void
Refer to Current TE Standard Revision
TE Standard available in KART

STATE	PROJECT NO.	YEAR	SHEET NO.	TOTAL SHEETS
KANSAS				

SIGN LAYOUT INFORMATION

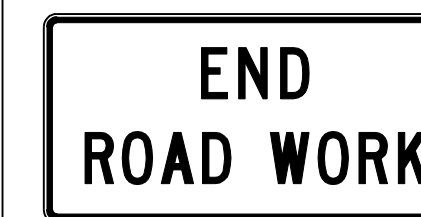

KG20-2
(BLACK ON ORANGE)

STD. SIZE
EXPWY/FREEWAY
6" C
48" x 24"

LETTER SIZES FOR BLACK ON ORANGE "DESTINATION" SIGNS
STD. SIZE
EXPWY/FREEWAY
6" C
10" D



KM4-20
(BLACK ON ORANGE)

STD. SIZE
EXPWY/FREEWAY
3" C
24" x 6" 6" C
48" x 12"

NOTE:

TEXT DIMENSIONS ARE IN INCHES.
BORDER IS BLACK NON-REFLECTIVE.
SEE STD. TE730 OR TE731 FOR KG20-5 SIGN LAYOUT.

ADVANCE WARNING SIGN SPACING (IN FEET):

	A	B	C
URBAN (40 MPH OR LOWER)	100	100	100
URBAN (45 MPH OR HIGHER)	350	350	350
RURAL (55 MPH OR LOWER)	500	500	500
RURAL (60 MPH OR HIGHER)	750	750	750
EXPRESSWAY/FREEWAY	1000	1500	2640

THE SPACING BETWEEN ANY SIGNS MAY BE ADJUSTED AS APPROVED BY THE ENGINEER IN ORDER TO MAXIMIZE VISIBILITY.

THE SPACING BETWEEN SIGNS SHALL BE NO LESS THAN 100', UNLESS DIRECTED BY THE ENGINEER.

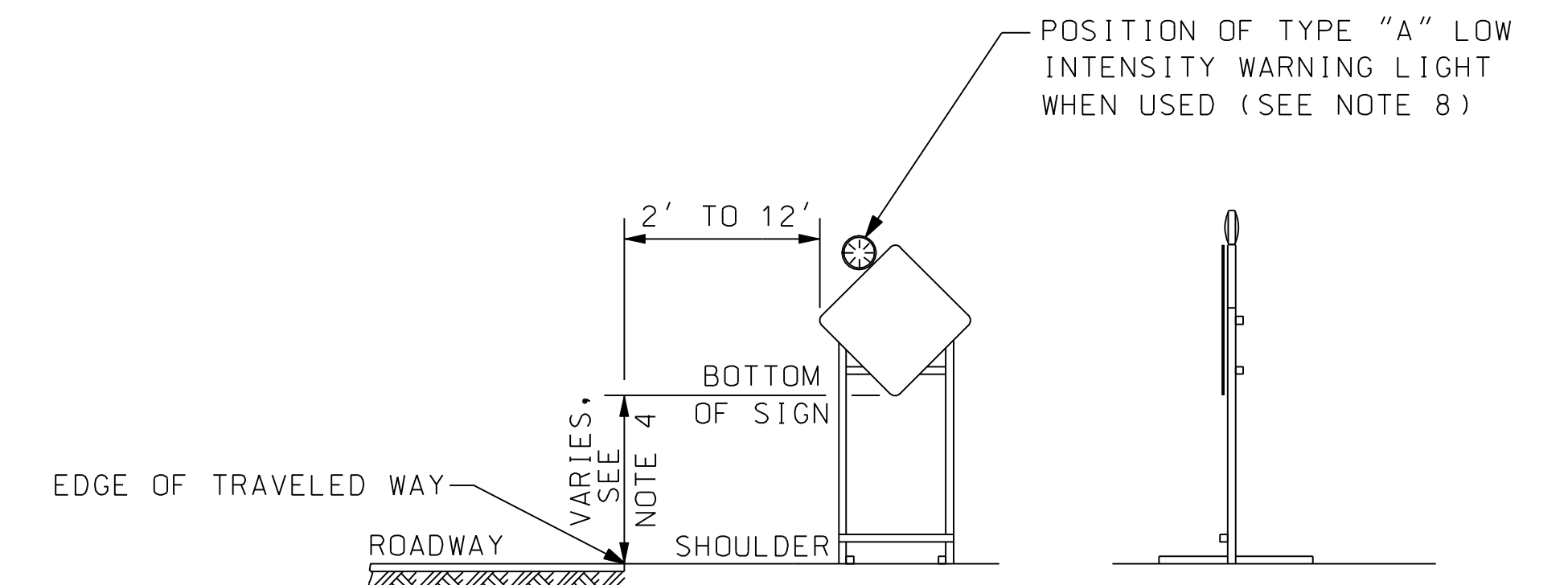

(SEE NOTE 4 FOR "ROLL-UP" SIGNS OPTION)

HEIGHT AND LATERAL DIMENSIONS FOR SIGNS MOUNTED ON SKIDS OR OTHER SUPPORTS ON PAVEMENT

3	8-8-07	MODIFIED NOTES 4, 5, 6, 7 & 8, KG20-2 LAYOUT	M.B.	A.A.A.
2	12-29-05	MODIFIED FLAGS, M4-20 & SIGN LAYOUT INFO	M.B.	A.A.A.
1	2-1-05	MODIFIED NOTE *9	B.H.	A.A.A.
NO.	DATE	REVISIONS	BY	APP'D

KANSAS DEPARTMENT OF TRANSPORTATION

TRAFFIC CONTROL SIGNS

TE710 9/1/00

FHWA APPROVAL	8-8-07	APP'D	Anthony A. Alrobaire
DESIGNED	B.A.H.	DETAILED	B.A.H.
DESIGN CK.	DETAIL CK.	QUANTITIES	QUAN. CK.
		TRACED	TRACE CK.

Plotted By : manjbr
 Plot File : L:\Traffic\Traffic Control\Working Revisions\English dgm\te710.dgn
 Plot Date : 8/14/2007

STATE	PROJECT NO.	YEAR	SHEET NO.	TOTAL SHEETS
KANSAS				

REFER TO STD. TE710 FOR ADDITIONAL INFORMATION ON TEMPORARY TRAFFIC CONTROL SIGNS AND SIGN SPACING.
REFER TO STD. TE702 FOR INFORMATION ON TAPERS AND CHANNELIZING DEVICES.
REFER TO STD. TE700 FOR LENGTH OF BUFFER SPACE.

NOTE:

NO TRAFFIC CONTROL IS REQUIRED IF THE WORK SPACE IS LOCATED OUTSIDE OF THE CLEAR ZONE.

FOR OPERATIONS OF 60 MINUTES OR LESS, ALL SIGNS AND CHANNELIZING DEVICES MAY BE ELIMINATED IF A VEHICLE WITH HIGH-INTENSITY ROTATING, FLASHING, OSCILLATING, OR STROBE LIGHTS IS USED.

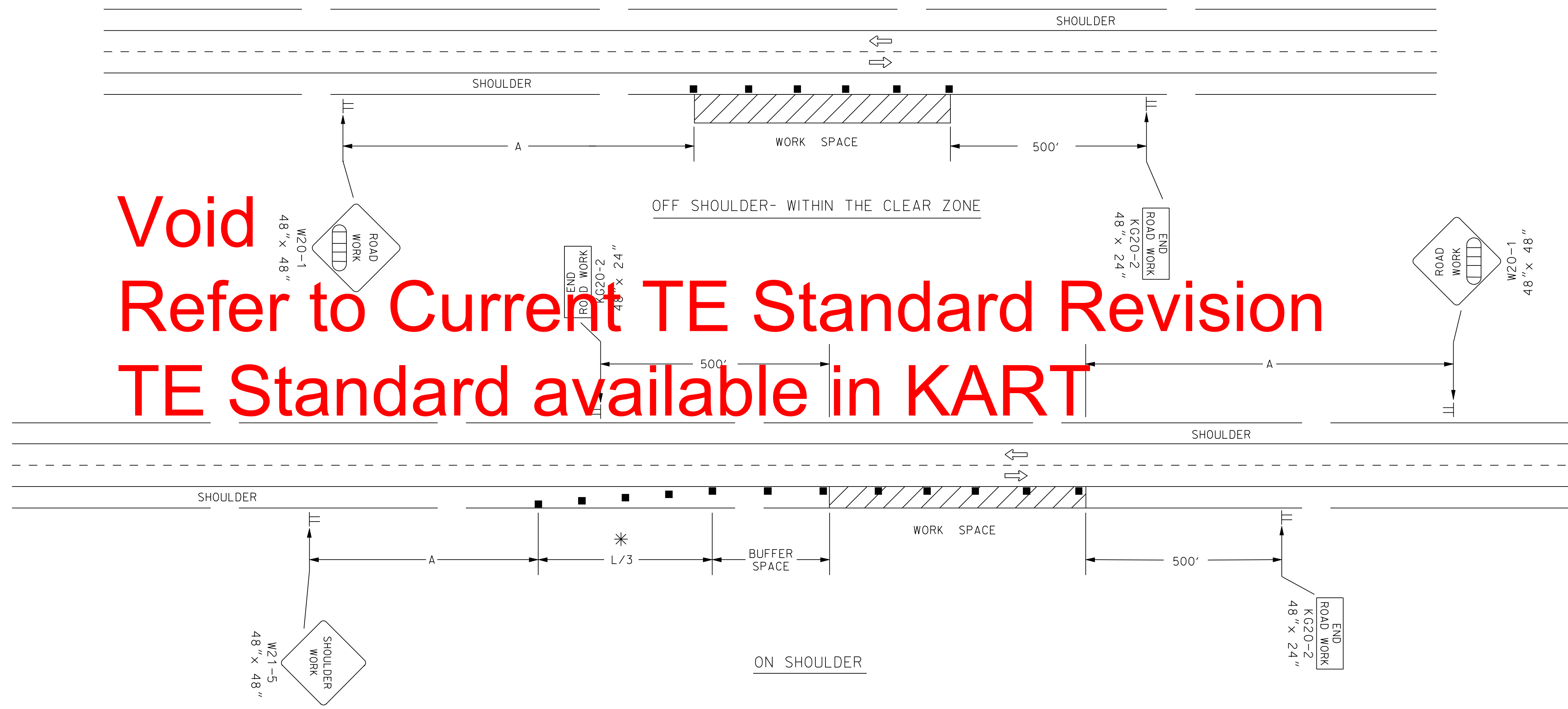

Void
Refer to Current TE Standard Revision
TE Standard available in KART

WHEN CONCRETE BARRIER SYSTEM IS USED, PORTABLE CHANNELIZING DEVICES ARE NOT NEEDED ALONG THE TANGENT BARRIER SECTION. DELINEATION ON THE BARRIER SYSTEM IS STILL REQUIRED. SEE RD622.

* OMIT TAPER IF PAVED SHOULDER IS LESS THAN 8' WIDE.

■ Channelizing Device
□ AHEAD, 1500 FT. OR 1 MILE

Plotted By : \$\$USERNAME\$\$
Plot File : \$\$\$DGN\$\$\$
Plot Date : \$\$\$SYTIME\$\$\$

3	8-8-07	G20-2 CHANGED TO KG20-2	M.B.	A.A.A.
2	12-29-05	UPDATED END ROAD WORK SIGN DESIGNATION	M.B.	A.A.A.
1	11-19-03	CHANGED BORDER	B.H.	S.A.B.
NO.	DATE	REVISIONS	BY	APP'D

KANSAS DEPARTMENT OF TRANSPORTATION
TYPICAL TRAFFIC CONTROL
WORK ON OR NEAR THE SHOULDER
UNDIVIDED HIGHWAY (2 OR 4 LANE)
TE720 **9/1/00**

DESIGNED	L.E.R.	APP'D	Anthony A. Airboire
DETAIL CK.	B.A.H.	QUANTITIES	TRACED
DESIGN CK.	DETAIL CK.	QUAN. CK.	TRACE CK.

STATE	PROJECT NO.	YEAR	SHEET NO.	TOTAL SHEETS
KANSAS				

REFER TO STD. TE710 FOR ADDITIONAL INFORMATION ON TEMPORARY TRAFFIC CONTROL SIGNS AND SIGN SPACING.
REFER TO STD. TE702 FOR INFORMATION ON TAPERS AND CHANNELIZING DEVICES.
REFER TO STD. TE700 FOR LENGTH OF BUFFER SPACE.

NOTE:

FOR WORK IN THE MEDIAN, INSTALL SIGNS AND CHANNELIZING DEVICES FOR EACH DIRECTION OF TRAFFIC ACCORDING TO THE APPLICABLE TYPICAL DRAWING.

NO TRAFFIC CONTROL IS REQUIRED IF THE WORK SPACE IS LOCATED OUTSIDE OF THE CLEAR ZONE.

FOR OPERATIONS OF 60 MINUTES OR LESS, ALL SIGNS AND CHANNELIZING DEVICES MAY BE ELIMINATED IF A VEHICLE WITH A HIGH-INTENSITY ROTATING, FLASHING, OSCILLATING, OR STROBE LIGHT IS USED.

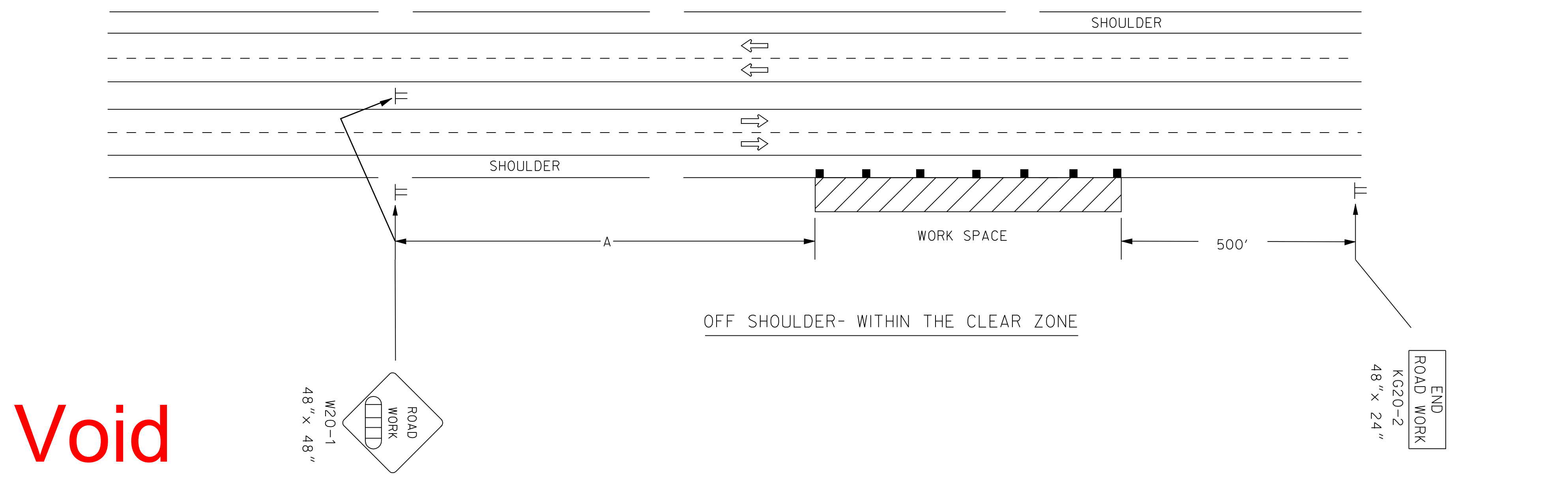

Void
Refer to Current TE Standard Revision
TE Standard available in KART

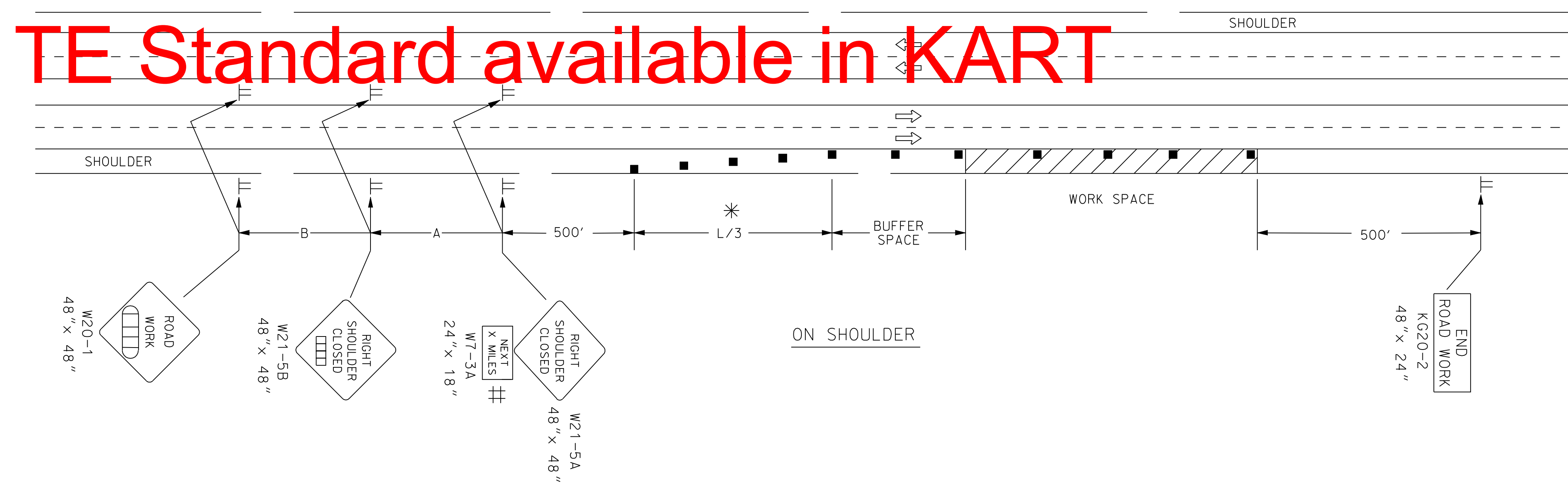

WHEN CONCRETE BARRIER SYSTEM IS USED, PORTABLE CHANNELIZING DEVICES ARE NOT NEEDED ALONG THE TANGENT BARRIER SECTION. DELINEATION ON THE BARRIER SYSTEM IS STILL REQUIRED. SEE RD622.

ELIMINATE W7-3A IF SHOULDER IS CLOSED FOR LESS THAN 2 MILES.

* OMIT TAPER IF PAVED SHOULDER IS LESS THAN 8' WIDE.

- X Length To The Nearest Whole Mile
- Channelizing Device
- ▢ AHEAD, 1500 FT, OR 1 MILE
- ▢ AHEAD, 1000 FT, 1500 FT OR 1/2 MILE

Plotted By : ##USERNAME##
Plot File : #####DGN#####
Plot Date : #####SYTIME#####

NO.	DATE	REVISIONS	BY	APP'D
3	8-8-07	G20-2 CHANGED TO KG20-2	M.B.	A.A.A.
2	12-29-05	UPDATED END ROAD WORK SIGN DESIGNATION	M.B.	A.A.A.
1	11-19-03	CHANGED BORDER	B.H.	S.A.B.

KANSAS DEPARTMENT OF TRANSPORTATION
TYPICAL TRAFFIC CONTROL
WORK ON OR NEAR THE SHOULDER
DIVIDED HIGHWAY

TE722 9/1/00

DESIGNED	L.E.R.	APP'D	Anthony A. Alrobalre
DESIGN CK.	DETAIL CK.	QUANTITIES	TRACED
		QUAN. CK.	TRACE CK.

REFER TO STD. TE710 FOR ADDITIONAL INFORMATION ON TEMPORARY TRAFFIC CONTROL SIGNS AND SIGN SPACING. REFER TO STD. TE702 FOR INFORMATION ON TAPERS AND CHANNELIZING DEVICES. REFER TO STD. TE700 FOR LENGTH OF BUFFER SPACE.

NOTE: TRUCKS HAULING MATERIAL TO THE PROJECT ARE REQUIRED TO STOP AT FLAGGER. AFTER STOPPING, UPON APPROVAL OF ENGINEER, TRUCKS MAY BE ALLOWED TO MOVE AROUND FLAGGER.

APPLY THIS DETAIL (TE730) FOR ALL SHOULDERS (EXCLUDING CONCRETE SHOULDERS EQUAL TO OR GREATER THAN 8')

FLAGGER

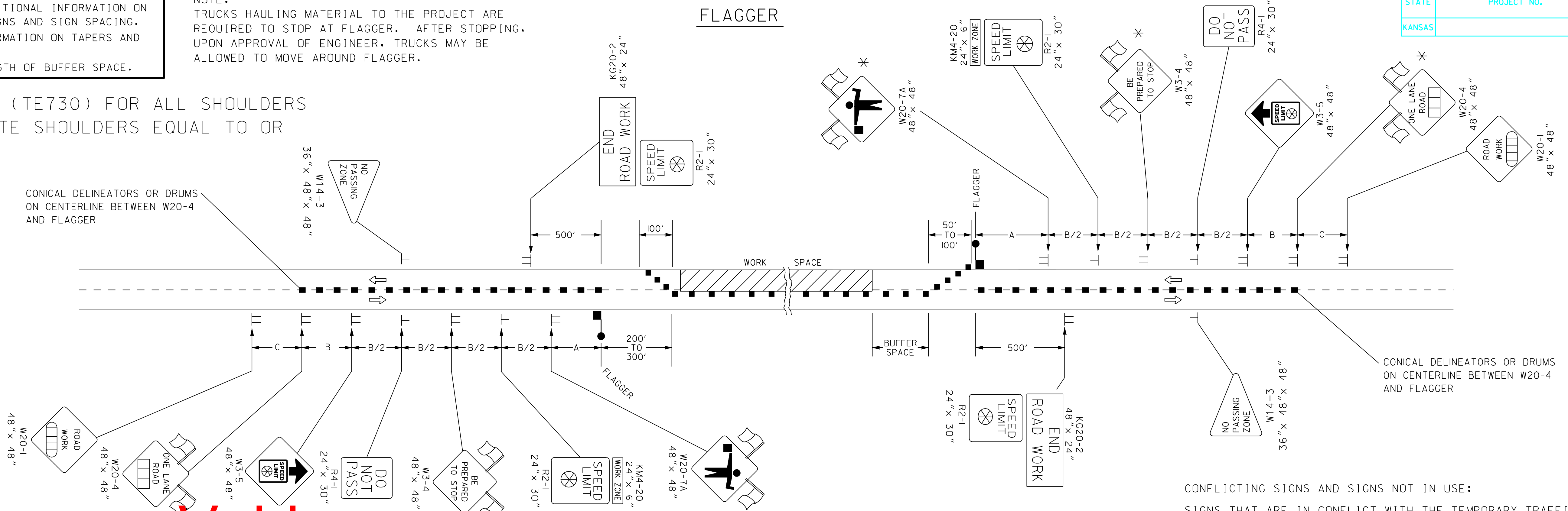

- Channelizing Device
- AHEAD, 1500 FT. OR 1 MILE
- AHEAD, 1000 FT, 1500 FT, OR 1/2 MILE
- ⊗ Speed To Be Determined By The Engineer
- Type "A" Low Intensity Warning Light

CONFLICTING SIGNS AND SIGNS NOT IN USE: SIGNS THAT ARE IN CONFLICT WITH THE TEMPORARY TRAFFIC CONTROL PLAN OR DO NOT APPLY TO THE TRAFFIC OPERATIONS SHALL BE IMMEDIATELY REMOVED, TURNED SO NOT VISIBLE TO TRAFFIC FROM ANY DIRECTION, OR COMPLETELY COVERED WITH ADEQUATE OPAQUE WATERPROOF MATERIAL. TAPE SHALL NOT BE APPLIED TO THE FACE OF THE SIGN.

Void
Refer to Current TE Standard Revision
TE Standard available in KART

FLAGGER AND PILOT CAR

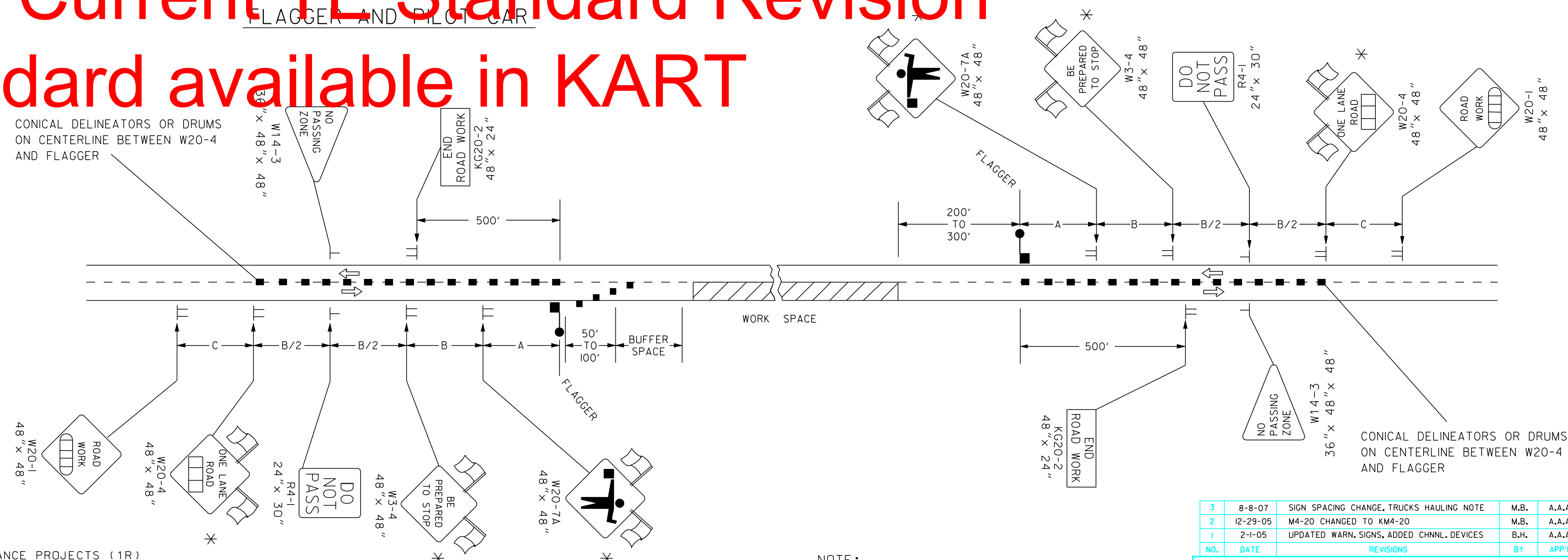

NOTE: EXISTING SIGNS SHALL NOT BE COVERED OR REMOVED BETWEEN FLAGGER STATIONS.

* WHEN APPLICABLE, USE TYPE "A" LOW INTENSITY WARNING LIGHTS FOR NIGHTTIME OPERATIONS ONLY OR AS DIRECTED BY ENGINEER.

NOTE: PLACE A FLAGGER AT ALL HIGHWAY AND MAJOR COLLECTOR INTERSECTIONS IN THE WORK SPACE. WHEN NECESSARY A FLAGGER AT A MINOR SIDE ROAD INTERSECTION SHALL BE DETERMINED BY THE ENGINEER. A SINGLE FLAGGER AT EACH INTERSECTION IS SUBSIDIARY TO OTHER ITEMS. IF REQUESTED BY THE ENGINEER, EACH ADDITIONAL FLAGGER WILL BE MEASURED AND PAID FOR EACH HOUR THEY ARE REQUIRED. PLACE A W20-7A (FLAGGER SYMBOL) SIGN ON EACH SIDE ROAD APPROACH THAT IS CONTROLLED BY A FLAGGER.

△ NOT REQUIRED ON SUBSTANTIAL MAINTENANCE PROJECTS (1R)

△△ THE KG20-5 (WAIT FOR PILOT CAR) SIGN SHALL BE MOUNTED ON AN APPROVED PORTABLE SUPPORT AND NOT ATTACHED TO THE EXISTING STOP SIGN POST.

△△ THE KG20-5 SIGN SHALL BE PLACED IMMEDIATELY IN FRONT OF THE EXISTING STOP SIGN, A MINIMUM OF 6" BELOW THE BOTTOM OF THE STOP SIGN. THE SIGN SHOULD BE REMOVED OR COVERED WHEN THERE IS NO PILOT CAR.

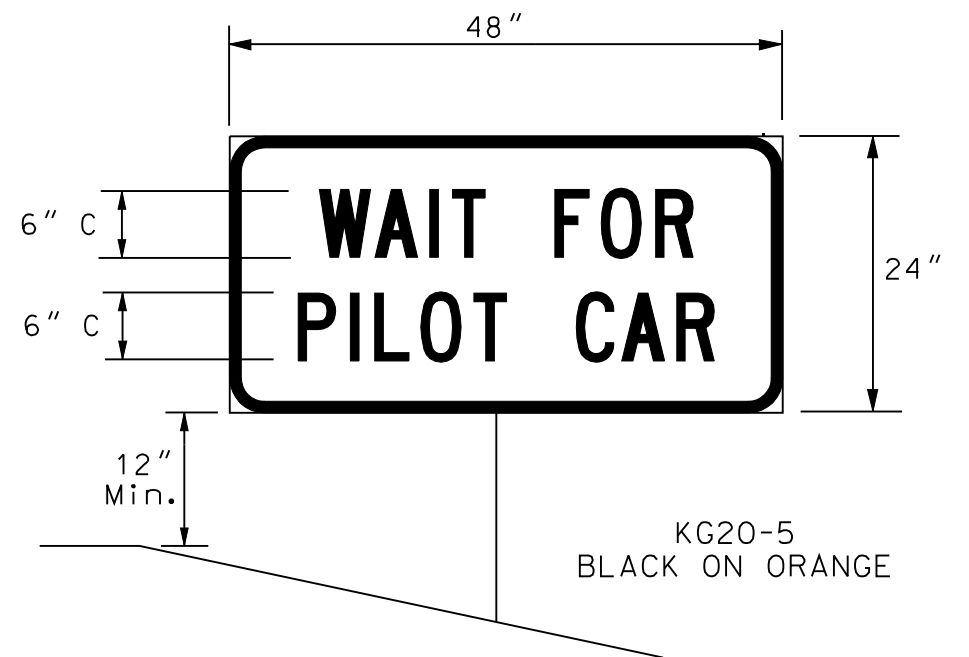

TYPICAL SIGNING FOR A MINOR SIDE ROAD APPROACH TO WORK SPACE

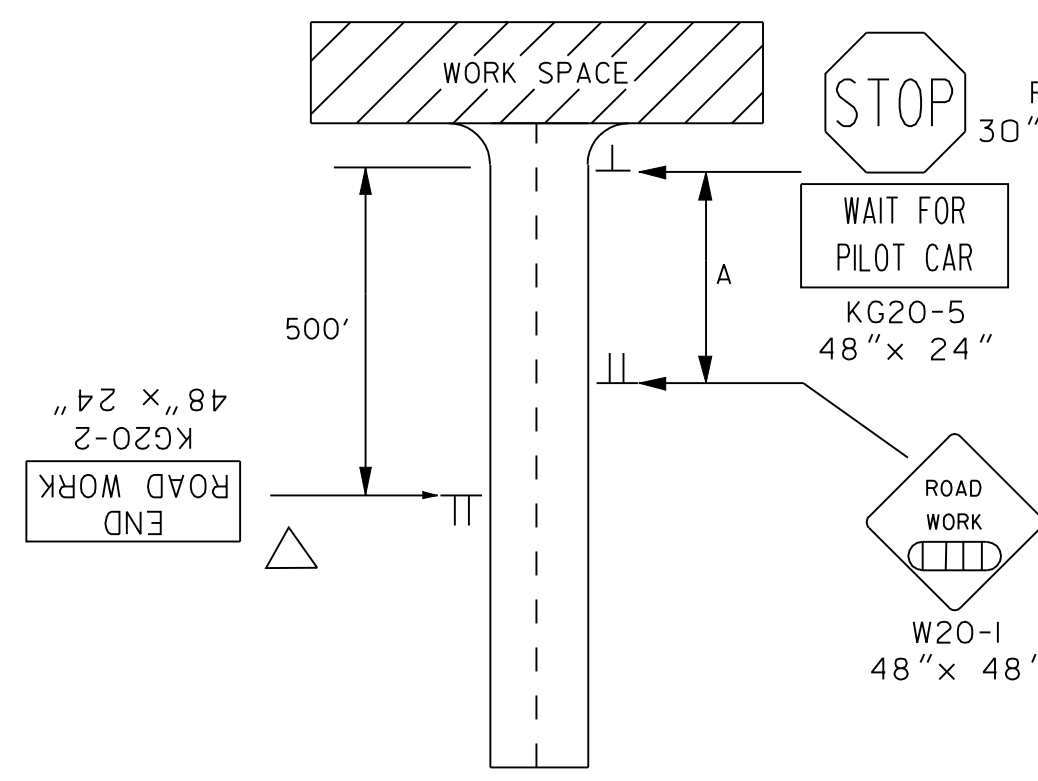

NO.	DATE	REVISIONS	BY	APP'D
3	8-8-07	SIGN SPACING CHANGE, TRUCKS HAULING NOTE	M.B.	A.A.A.
2	12-29-05	M4-20 CHANGED TO KM4-20	M.B.	A.A.A.
1	2-1-05	UPDATED WARN, SIGNS, ADDED CHNNL. DEVICES	B.H.	A.A.A.

KANSAS DEPARTMENT OF TRANSPORTATION
TYPICAL TRAFFIC CONTROL FLAGGER OR PILOT CAR
TWO-LANE ONE LANE CLOSED
EXCLUDING CONCRETE SHOULDERS
EQUAL TO OR GREATER THAN 8'

TE730	9/1/00
DESIGNED BY: B.A.H.	QUANTITIES BY: B.A.H.
DETAIL CK: B.A.H.	QUAN. CK: B.A.H.
APP'D: Anthony A. Alrobaire	TRACED BY: B.A.H.
	TRACE CK: B.A.H.

Plotted By : \$\$USERNAME\$\$
 Plot File : \$\$\$SYTIME\$\$\$
 Plot Date : \$\$\$SYTIME\$\$\$

REFER TO STD. TE710 FOR ADDITIONAL INFORMATION ON TEMPORARY TRAFFIC CONTROL SIGNS AND SIGN SPACING.
 REFER TO STD. TE702 FOR INFORMATION ON TAPERS AND CHANNELIZING DEVICES.
 REFER TO STD. TE700 FOR LENGTH OF BUFFER SPACE.

NOTE:
 TRUCKS HAULING MATERIAL TO THE PROJECT ARE REQUIRED TO STOP AT FLAGGER. AFTER STOPPING, UPON APPROVAL OF ENGINEER, TRUCKS MAY BE ALLOWED TO MOVE AROUND FLAGGER.

APPLY THIS DETAIL (TE731) FOR ALL ROADWAYS WITH CONCRETE SHOULDERS EQUAL TO OR GREATER THAN 8' WIDE WITH OR WITHOUT EXISTING RUMBLE STRIPS

- Channelizing Device
- ▨ AHEAD, 1500 FT. OR 1 MILE
- ▨ AHEAD, 1000 FT, 1500 FT, OR 1/2 MILE
- ⊗ Speed To Be Determined By The Engineer
- Type "A" Low Intensity Warning Light
- ||| Existing Shoulder Rumble Strips

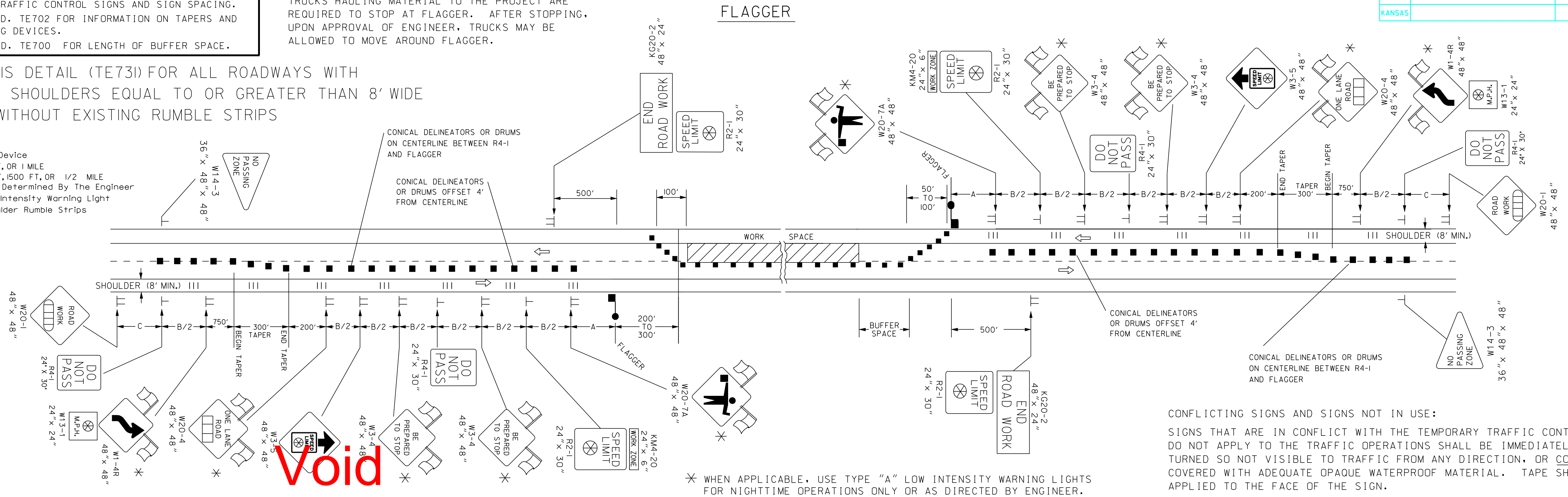

CONFLICTING SIGNS AND SIGNS NOT IN USE:
 SIGNS THAT ARE IN CONFLICT WITH THE TEMPORARY TRAFFIC CONTROL PLAN OR DO NOT APPLY TO THE TRAFFIC OPERATIONS SHALL BE IMMEDIATELY REMOVED, TURNED SO NOT VISIBLE TO TRAFFIC FROM ANY DIRECTION, OR COMPLETELY COVERED WITH ADEQUATE OPAQUE WATERPROOF MATERIAL. TAPE SHALL NOT BE APPLIED TO THE FACE OF THE SIGN.

* WHEN APPLICABLE, USE TYPE "A" LOW INTENSITY WARNING LIGHTS FOR NIGHTTIME OPERATIONS ONLY OR AS DIRECTED BY ENGINEER.

Refer to Current TE Standard Revision TE Standard available in KART

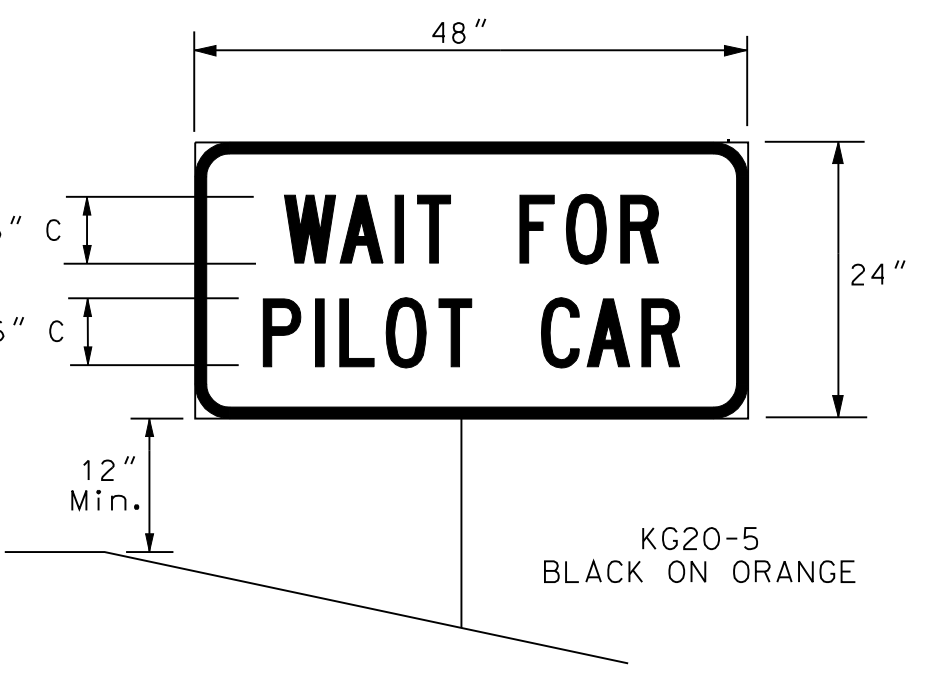

NOTE:
 PLACE A FLAGGER AT A HIGHWAY AND MAJOR COLLECTOR INTERSECTION IN THE WORK SPACE. THE NEED FOR A FLAGGER AT A MINOR SIDE ROAD INTERSECTION SHALL BE DETERMINED BY THE ENGINEER. A SINGLE FLAGGER AT EACH INTERSECTION IS SUBSIDIARY TO OTHER ITEMS. IF REQUESTED BY THE ENGINEER, EACH ADDITIONAL FLAGGER WILL BE MEASURED AND PAID FOR EACH HOUR THEY ARE REQUIRED. PLACE A W20-7A (FLAGGER SYMBOL) SIGN ON EACH SIDE ROAD APPROACH THAT IS CONTROLLED BY A FLAGGER.

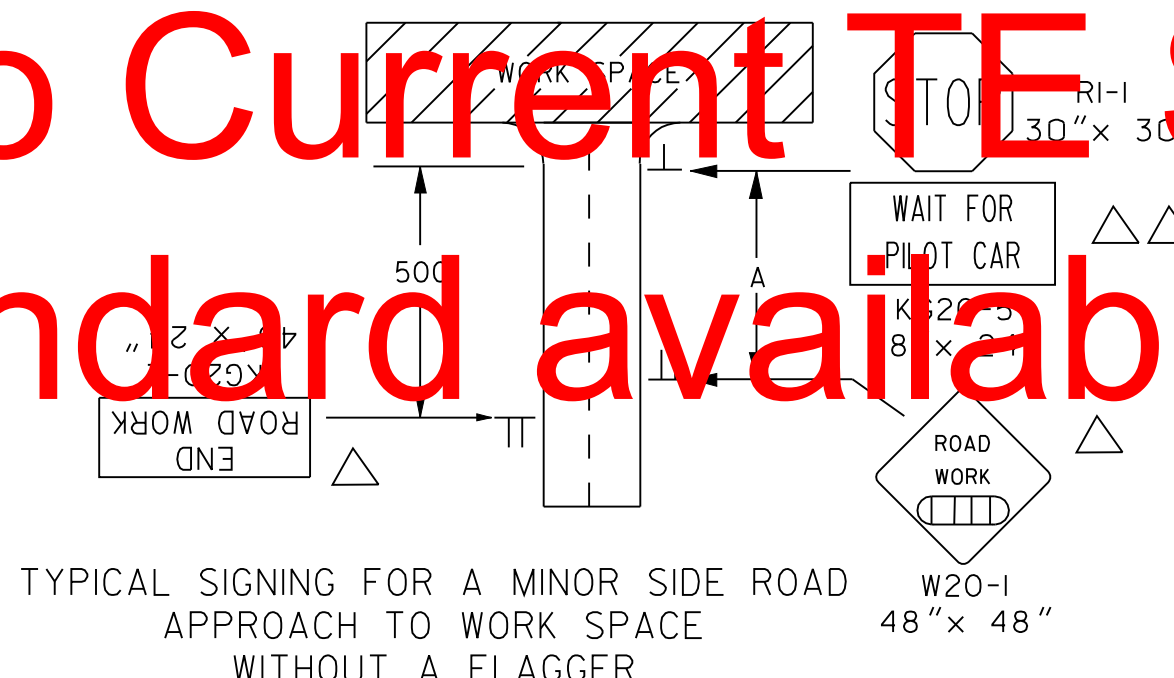

NOTE:
 THE KG20-5 (WAIT FOR PILOT CAR) SIGN SHALL BE MOUNTED ON AN APPROVED PORTABLE SUPPORT AND NOT ATTACHED TO THE EXISTING STOP SIGN POST.
 THE KG20-2 SIGN SHALL BE PLACED IMMEDIATELY IN FRONT OF THE EXISTING STOP SIGN, A MINIMUM OF 6" BELOW THE BOTTOM OF THE STOP SIGN. THE SIGN SHOULD BE REMOVED OR COVERED WHEN THERE IS NO PILOT CAR.

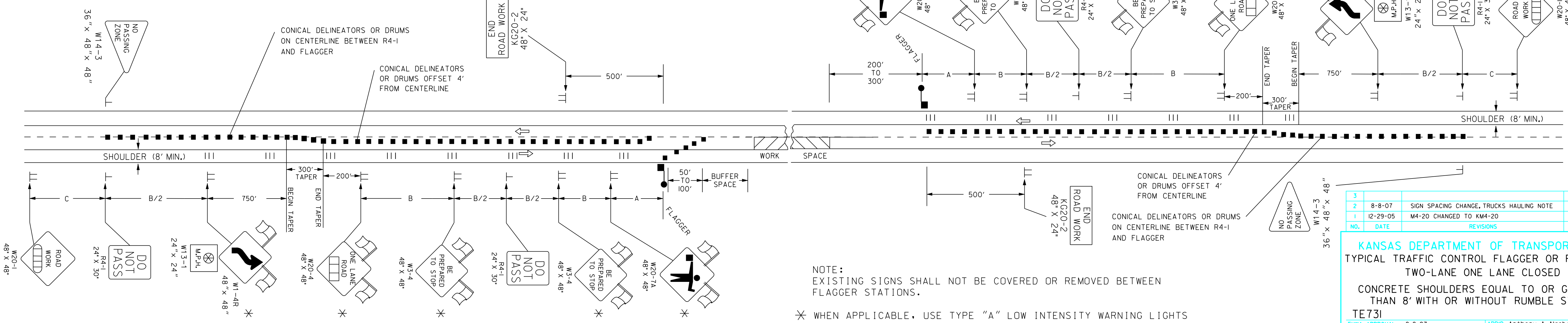

NOTE:
 EXISTING SIGNS SHALL NOT BE COVERED OR REMOVED BETWEEN FLAGGER STATIONS.

* WHEN APPLICABLE, USE TYPE "A" LOW INTENSITY WARNING LIGHTS FOR NIGHTTIME OPERATIONS ONLY OR AS DIRECTED BY ENGINEER.

NO.	DATE	REVISIONS	BY	APP'D
3	8-8-07	SIGN SPACING CHANGE, TRUCKS HAULING NOTE	M.B.	A.A.A.
1	12-29-05	M4-20 CHANGED TO KM4-20	M.B.	A.A.A.

KANSAS DEPARTMENT OF TRANSPORTATION				
TYPICAL TRAFFIC CONTROL FLAGGER OR PILOT CAR				
TWO-LANE ONE LANE CLOSED				
CONCRETE SHOULDERS EQUAL TO OR GREATER THAN 8' WITH OR WITHOUT RUMBLE STRIPS				
TE731 2/1/05				
DESIGNED	B.A.H.	APP'D	Anthony A. Alrobair	
DESIGN CK.	DETAIL CK.	QUANTITIES	TRACED	
		QUAN. CK.	TRACE CK.	

Plotted By : \$\$/USERNAME\$\$
 Plot File : \$\$\$SYTIME\$\$\$
 Plot Date : \$\$\$SYTIME\$\$\$

STATE	PROJECT NO.	YEAR	SHEET NO.	TOTAL SHEETS
KANSAS				

REFER TO STD. TE710 FOR ADDITIONAL INFORMATION ON TEMPORARY TRAFFIC CONTROL SIGNS AND SIGN SPACING.
REFER TO STD. TE704 FOR TYPE III BARRICADES.
REFER TO STD. TE702 FOR INFORMATION ON TAPERS AND CHANNELIZING DEVICES.
REFER TO STD. TE700 FOR LENGTH OF BUFFER SPACE.

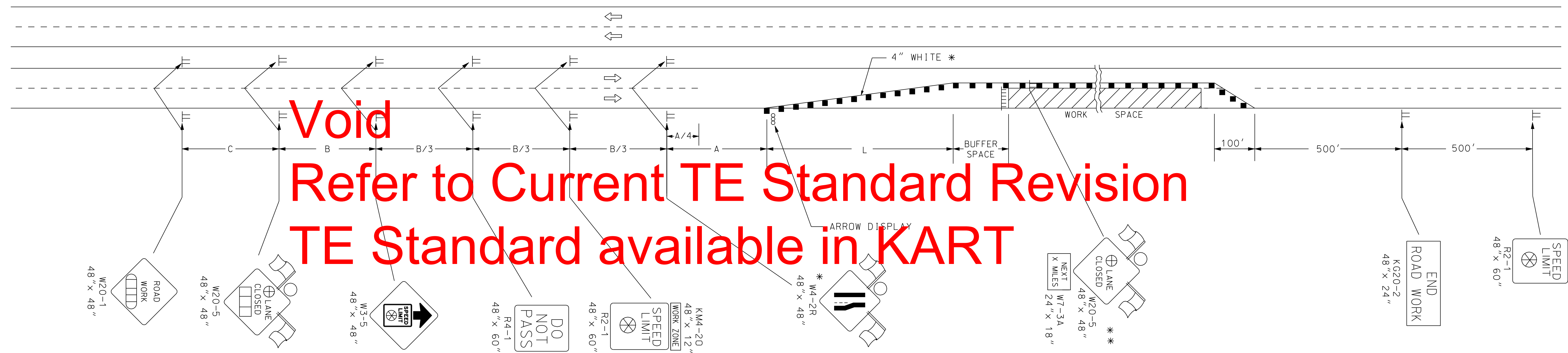

LEFT-SIDE SIGNS SHALL BE OMITTED FOR A FOUR-LANE UNDIVIDED HIGHWAY.

* FOR LEFT LANE CLOSURES USE W4-2L AND YELLOW EDGE LINE ALONG CHANNELIZING DEVICES.

** THE W20-5 (⊕ LANE CLOSED) AND W7-3A (NEXT X MILES) SIGNS SHOULD BE PLACED AT 2 MILE INCREMENTS ON A PROJECT OF 4 MILES OR LONGER.

- ||| Type III Barricades
- X Length To The Nearest Whole Mile
- Channelizing Device
- ▨ AHEAD, 1500 FT. OR 1 MILE
- ▩ AHEAD, 1000 FT, 1500 FT, OR 1/2 MILE
- ⊕ RIGHT OR LEFT
- ⊗ Speed To Be Determined By The Engineer
- Type "A" Low Intensity Warning Light

Plotted By : \$\$USERNAME\$\$
Plot File : \$\$\$SPEC\$\$\$
Plot Date : \$\$\$SYTIME\$\$\$

NO.	DATE	REVISIONS	BY	APP'D
3	8-8-07	SIGN SPACING CHANGE	M.B.	A.A.A.
2	12-29-05	M4-20 CHANGED TO KM4-20	M.B.	A.A.A.
1	2-1-05	CLARIFIED NOTES, UPDATED WARNING SIGNS	B.H.	A.A.A.

KANSAS DEPARTMENT OF TRANSPORTATION
TYPICAL TRAFFIC CONTROL
FOUR-LANE HIGHWAY
ONE LANE CLOSED

TE744 9/1/00

DESIGNED	B.A.H.	APP'D	Anthony A. Airobalre
DESIGN CK.	DETAIL CK.	QUANTITIES	TRACE CK.

THIS PAGE LEFT BLANK FOR NOTES

(This Page Intentionally Left Blank)

Maint.
Petitioner
District
Area
City or Sub-Area

KANSAS DEPARTMENT OF TRANSPORTATION
Bureau of Maintenance

**HIGHWAY PERMIT
USE OF RIGHT OF WAY**

Permit No. _____
Route _____
Co. _____
State Highway _____
City Conn. Link _____
City _____

Emergency Contact (24/7)

THIS AGREEMENT, made and entered into, between the Secretary of Transportation of the State of Kansas, referred to as "Secretary" and _____ (Name of Firm or Individual) (Tel. No.) _____, referred to as "Petitioner" and the City of _____ (Street) _____ (City) _____ (State) _____ (Zip) _____, referred to as "City".
(If Not Applicable, Enter N/A)

Secretary has jurisdiction over highway right-of-ways within the State Highway System of Kansas, and

Secretary (and City) believe it is in the interest of the Citizens of the State of Kansas to permit certain work or projects to be performed upon Highway right-of-ways, and

Petitioner requests permission and authority from Secretary (and City) to perform certain work, described as follows:

Said work is located on public right-of-way in, upon or along State Highway Route _____, Reference Point _____ (or City Connecting Link Route _____ on _____ St.) in Sec. _____ TWP. _____ Range _____, _____ County, _____ Miles(km) _____ (direction) from _____ (Jct. or county line) and

Secretary has delegated full and complete authority to the District Engineers of the Kansas Department of Transportation (KDOT) to execute Highway Permit Agreements, referred to as "Permits," for and on Secretary's behalf.

In consideration of the permission granted by the Secretary (and City) to utilize Highway right-of-way(s) in the manner described above, the following terms and conditions are mutually agreed to by the Petitioner, the Secretary (and the City).

1.0 PLANS: Petitioner shall furnish two (2) sets of comprehensive plan sets or detailed drawings 11" x 17", and/or electronic pdf copy of the proposed work. Sketches, cut sheets, and/or documentation may be submitted on 8 1/2" x 11".

1.1 Plans for utility installations must include a description of the size, type, and method of installation for the proposed Facilities to be located within highway right-of-ways, and adequate detailed drawings indicating the location of the proposed installation with respect to the traveled way of the highway, the right-of-way lines and, where applicable, the control of access lines,

1.2 An accurate "As Built" Construction Plan shall be provided for deviation from the approved Plan.

2.0 MATERIAL AND METHODS: All requests to perform work in, upon or along Highway right-of-ways must be approved by the District Engineer (and City). In Cities, Petitioner will obtain additional Permits, as required by City.

2.1 The Petitioner shall furnish all material, do all work and pay all costs for the work described on this Permit,

2.2 All utility installations shall comply with the conditions and applicable requirements of the KDOT Utility Accommodation Policy, current edition, which is incorporated by reference in its entirety (and City standards when they exceed those of KDOT).

2.3 Drainage structure requirements shall be determined by Petitioner, but requirements are subject to review and approval by the District Engineer (and City).

2.4 All materials and construction methods used on work within the limits of the right-of-way shall meet or exceed the requirements of the "Standard Specifications for State Road and Bridge Construction," current edition. The Standard Specifications are available at www.ksdot.org.

3.0 INITIATION AND COMPLETION OF WORK: Petitioner agrees to notify the District Engineer (and City) or their duly authorized

KDOT representative _____ before work is initiated and again when the work is completed.

3.1 An approved signed copy of this Permit shall be on the premises at the start and during the period any work is performed.

3.2 All-work, including right-of-way restoration, shall be completed within _____ calendar days of APPROVAL DATE, otherwise this Permit is rescinded. If work has not been started within the completion time, this Permit becomes null and void.

4.0 INSPECTION: Petitioner will be responsible for supervising construction to insure compliance with KDOT (and City) policies and standards.

5.0 ACCEPTANCE: (Check One) KDOT ; City ; will be responsible for acceptance of restored right-of-way.

6.0 RIGHT-OF-WAY: Except for authorized changes, Petitioner shall restore the right-of-way to a condition equal to or better than existed prior to approval of the work described on this Permit.

6.1 Any sod, shrubs or trees destroyed by this work shall be replaced as directed by the District Engineer (and City).

6.2 The right-of-way shall be kept free from parking, advertising signs or any other commercial activity.

7.0 OBSTRUCTION OF TRAFFIC: Petitioner shall ensure highway (and connecting link) traffic will be free of interference unless specifically provided for as a part of this Permit. All temporary traffic control devices and their installation and maintenance shall comply with the latest edition of the Manual on Uniform Traffic Control Devices (MUTCD for streets and highways which has been adopted by the Secretary). Whenever the temporary Traffic Control Standards conflict with the MUTCD, the Standards shall govern. Workers shall wear approved safety vests according to 23 CFR Part 634, Worker Visibility.

8.0 MAINTENANCE: All utility installations shall be maintained or caused to be maintained by Petitioner.

9.0 PERMIT REVOCATION: In lieu of bond, Secretary may revoke the permit and remove any work performed. The Petitioner shall reimburse the Secretary for any cost incurred by Secretary to restore the right-of-way. The Secretary will not authorize any other highway permits until Petitioner has either reimbursed Secretary or restored the right-of-way.

10.0 LIABILITY: Petitioner shall indemnify and hold harmless Secretary from personal injury and property damage claims arising out of any act or omission of Petitioner. If Secretary defends a third party's claim, the Petitioner shall indemnify Secretary for personal injury damages, property damages and related expenses Secretary incurs arising out of Petitioner's act or omission. For purposes of this provision, the term Petitioner includes Petitioner's employees, agents, subcontractors (at any tier), suppliers (at any tier), successors, and assigns.

10.1 INSURANCE: Liability Insurance. Petitioner shall carry "General Liability" insurance under an occurrence policy that has a minimum combined single limit of \$2,000,000 for personal injury and property damage and that contains the following coverage: Comprehensive Form, Premises-Operation, Underground Hazard, Products/Completed Operations Hazard, Contractual Insurance, Broad form Property Damage, Independent Contractors, and Personal Injury. Worker's Compensation: Petitioner shall carry "Worker's Compensation and Employer's Liability" insurance that complies with Kansas Statute. Automobile Liability: Petitioner shall carry "Automobile Liability" insurance under an occurrence policy that has a minimum combined single limit of \$1,000,000.00 for personal injury and property damage and that contains the following coverage: Comprehensive Form, Owned, Hired, and Non-Owned.

10.2 "Certificate of Insurance". This permit shall not take effect unless Petitioner provides Secretary a "Certificates of Insurance" confirming Petitioner carries insurance in the amounts and type this section requires. Petitioner shall obtain insurance only from insurers on the approved Federal Treasury List and authorized by the Kansas Commissioner of Insurance. The "Certificates of Insurance" shall include a clause requiring the insurer to notify Secretary thirty (30) calendar days in advance of cancellation of the insurance contracts.

10.3 Petitioner shall maintain the insurance required in Section 10.1 until the District Engineer releases the Petitioner from any Permit obligation.

11.0 DAMAGE TO UTILITIES: KDOT shall not be liable for damage to any utility not installed in the location authorized by any permit or agreement issued pursuant to the Utility Accommodation Policy.

12.0 PIPELINE LIABILITY: For attachments to bridges or other structures and for roadway crossings of PIPELINES CARRYING PETROLEUM, HAZARDOUS AND/OR CORROSIVE PRODUCTS, Petitioner shall solely assume all risk and liability for accidents and damages that may occur to persons, property or natural resources by reason of the operation of the pipeline attached to said bridge, structure or crossing of roadway.

12.1 Petitioner shall maintain the insurance required in Section 9.0 for as long as the pipeline remains attached to the bridge or other structure or for as long as the pipeline crosses the roadway. The insurance contract shall cover claims for such length of time as the law permits such claims.

13.0 ENVIRONMENTAL LIABILITY AND INDEMNIFICATION: Petitioner shall comply with all applicable federal, state, and local statutes, regulations and ordinances relating to environmental protection, and health and safety in Petitioner's acts on, or occupation of, the Highway right-of-way(s). Petitioner assumes all risk and liability for, or resulting from, any environmental condition on, at, or leaving the Highway(s) caused by or arising out of Petitioner's, or its agents' or contractors' acts, omissions, or occupation, in whole or in part, of the Highway right-of-way(s). Petitioner shall hold harmless and indemnify the Secretary against all liability, cost, expense, and fines incurred by or levied against the Secretary under any federal, state or local environmental law, regulation, or ordinance resulting from Petitioner's breach of this paragraph or as a result of Petitioner's acts or occupation of the Highway right-of-way(s) pursuant to this Permit. For purpose of this provision, the term Petitioner includes Petitioner's employees, agents, subcontractors (at any tier), suppliers (at any tier), successors and assigns.

14.0 HIGHWAY IMPROVEMENTS AND/OR MAINTENANCE: If Secretary makes any alteration or improvement along or upon the highway right-of-way which is the subject of this Permit, Petitioner shall hold Secretary harmless for any and all damage or injury to Petitioner's Facilities, whether finished or unfinished, as well as damage or injury to Petitioner's equipment, materials, employees, agents or contractees. Petitioner shall conduct all work approved on this permit in such a manner as not to interfere with construction or other work being performed by the KDOT (or City) or its contractors in the vicinity of Petitioner's work or project.

14.1 Within a reasonable time after receiving written notice from Secretary that Petitioner's Facilities are in conflict with KDOT's new construction or major maintenance operations, Petitioner shall alter, change location or move their construction work or Facilities without cost or expense to the Secretary. If Petitioner fails to relocate their Facilities within a reasonable time, KDOT may move the Facilities. Except for Rural Water Districts meeting the requirements of K.S. A. 68-415(c), Petitioner shall reimburse KDOT for the costs of relocating the Facilities upon receipt of an itemized statement. (See, K.S.A. 68-415). Petitioner shall reimburse KDOT for any construction costs, claims or expenses KDOT incurs as a result of Petitioner's failure to timely relocate the Facilities.

14.2 Written notice will not be required for KDOT's normal maintenance.

15.0 ABANDONED OR RETIRED IN PLACE: Petitioner shall notify Secretary when the Facilities will be abandoned or retired in place and shall submit a plan for abandonment or retirement in place to the District Engineer or designee for review and approval. Petitioner shall remove or abandon the Facilities in place in accordance with the approved plan. Petitioner shall pay all costs associated with removal of abandoned or retired in place upon highway right-of-way Facilities.

This Permit is hereby accepted and its provisions agreed to by the Parties.

APPROVED:

PETITIONER:

CITY OF _____

(when applicable)

Mayor City Mgr. City Engr.

City Clerk

City Contact Email

Signature

Printed Name

Street Address (City, State, Zip Code)

Agent Lesse Contractor

Street Address (City, State, Zip Code)

Contact Email

RECOMMENDED BY: _____

Area/Metro Engr. Area Supt. Utility Coord.

PERMIT APPROVAL:

SECRETARY OF TRANSPORTATION
OF THE STATE OF KANSAS

BY: _____

District Engineer

Date

Maint.
Petitioner
District
Area
City or Sub-Area

KANSAS DEPARTMENT OF TRANSPORTATION
Bureau of Maintenance

**HIGHWAY PERMIT
USE OF RIGHT OF WAY**

Permit No. _____
Route _____
Co. _____
State Highway _____
City Conn. Link _____
City _____

Emergency Contact (24/7)

THIS AGREEMENT, made and entered into, between the Secretary of Transportation of the State of Kansas, referred to as

"Secretary" and _____ (Name of Firm or Individual) (Tel. No.) _____

_____ (Street), _____ (City), _____ (State), _____ (Zip),
referred to as "Petitioner" and the City of _____, referred to as "City".
(If Not Applicable, Enter N/A)

Secretary has jurisdiction over highway right-of-ways within the State Highway System of Kansas, and

Secretary (and City) believe it is in the interest of the Citizens of the State of Kansas to permit certain work or projects to be performed upon Highway right-of-ways, and

Petitioner requests permission and authority from Secretary (and City) to perform certain work, described as follows:

Said work is located on public right-of-way in, upon or along State Highway Route _____, Reference Point _____ (or City
Connecting Link Route _____ on _____ St.) in Sec. _____ TWP. _____ Range _____, _____ County,
_____ Miles(km) _____ (direction) from _____ (Jct. or county line) and

Secretary has delegated full and complete authority to the District Engineers of the Kansas Department of Transportation (KDOT) to execute Highway Permit Agreements, referred to as "Permit," for and on Secretary's behalf.

In consideration of the permission granted by the Secretary (and City) to utilize Highway right-of-way(s) in the manner described above, the following terms and conditions are mutually agreed to by the Petitioner, the Secretary (and the City).

1.0 PLANS: Petitioner shall furnish two (2) sets of comprehensive plans or detailed drawings, 8 1/2" x 11" or 11" x 17", or electronic pdf copy of the proposed work.

1.1 Plans for utility installations must include a description of the size, type, and method of installation for the proposed Facilities to be located within highway right-of-ways, and adequate detailed drawings indicating the location of the proposed installation with respect to the traveled way of the highway, the right-of-way lines and, where applicable, the control of access lines.

1.2 An accurate "As Built" Construction Plan shall be provided for deviation from the approved Plan.

2.0 MATERIAL AND METHODS: All requests to perform work in, upon or along Highway right-of-ways must be approved by the District Engineer (and City). In Cities, Petitioner will obtain additional Permits, as required by City.

2.1 The Petitioner shall furnish all material, do all work and pay all costs for the work described on this Permit.

2.2 All utility installations shall comply with the conditions and applicable requirements of the KDOT Utility Accommodation Policy, current edition, which is incorporated by reference in its entirety (and City standards when they exceed those of KDOT).

2.3 Drainage structure requirements shall be determined by Petitioner, but requirements are subject to review and approval by the District Engineer (and City).

2.4 All materials and construction methods used on work within the limits of the right-of-way shall meet or exceed the requirements of the "Standard Specifications for State Road and Bridge Construction," current edition. The Standard Specifications are available at www.ksdot.org.

3.0 INITIATION AND COMPLETION OF WORK: Petitioner agrees to notify the District Engineer (and City) or their duly authorized

KDOT representative _____

before work is initiated and again when the work is completed.

3.1 An approved signed copy of this Permit shall be on the premises at the start and during the period any work is performed.

3.2 All-work, including right-of-way restoration, shall be completed within _____ calendar days of APPROVAL DATE, otherwise this Permit is rescinded. If work has not been started within the completion time, this Permit becomes null and void.

4.0 INSPECTION: Petitioner will be responsible for supervising construction to insure compliance with KDOT (and City) policies and standards.

5.0 ACCEPTANCE: (Check One) KDOT ; City ; will be responsible for acceptance of restored right-of-way.

6.0 RIGHT-OF-WAY: Except for authorized changes, Petitioner shall restore the right-of-way to a condition equal to or better than existed prior to approval of the work described on this Permit.

6.1 Any sod, shrubs or trees destroyed by this work shall be replaced as directed by the District Engineer (and City).

6.2 The right-of-way shall be kept free from parking, advertising signs or any other commercial activity.

7.0 OBSTRUCTION OF TRAFFIC: Petitioner shall ensure highway (and connecting link) traffic will be free of interference unless specifically provided for as a part of this Permit. All temporary traffic control devices and their installation and maintenance shall comply with the latest edition of the Manual on Uniform Traffic Control Devices (MUTCD for streets and highways which has been adopted by the Secretary). Whenever the temporary Traffic Control Standards conflict with the MUTCD, the Standards shall govern. Workers shall wear approved safety vests according to 23 CFR Part 634, Worker Visibility.

8.0 MAINTENANCE: All utility installations shall be maintained or caused to be maintained by Petitioner.

9.0 PERMIT REVOCATION: In lieu of bond, Secretary may revoke the permit and remove any work performed. The Petitioner shall reimburse the Secretary for any cost incurred by Secretary to restore the right-of-way. The Secretary will not authorize any other highway permits until Petitioner has either reimbursed Secretary or restored the right-of-way.

10.0 LIABILITY: Petitioner shall indemnify and hold harmless Secretary from personal injury and property damage claims arising out of any act or omission of Petitioner. If Secretary defends a third party's claim, the Petitioner shall indemnify Secretary for personal injury damages, property damages and related expenses Secretary incurs arising out of Petitioner's act or omission. For purposes of this provision, the term Petitioner includes Petitioner's employees, agents, subcontractors (at any tier), suppliers (at any tier), successors, and assigns.

10.1 INSURANCE: Liability Insurance. Petitioner shall carry "General Liability" insurance under an occurrence policy that has a minimum combined single limit of \$2,000,000 for personal injury and property damage and that contains the following coverage: Comprehensive Form, Premises-Operation, Underground Hazard, Products Completed Operations Hazard, Contractual Insurance, Broad form Property Damage, Independent Contractors, and Personal Injury. Workers Compensation: Petitioner shall carry "Workers Compensation and Employer's Liability" insurance that complies with Kansas Statute. Automobile Liability: Petitioner shall carry "Automobile Liability" insurance under an occurrence policy that has a minimum combined single limit of \$1,000,000.00 for personal injury and property damage and that contains the following coverage: Comprehensive Form, Owned, Hired, and Non-Owned.

10.2 "Certificate of Insurance". This permit shall not take effect unless Petitioner provides Secretary a "Certificates of Insurance" confirming Petitioner carries insurance in the amounts and type this section requires. Petitioner shall obtain insurance only from insurers on the approved Federal Treasury List and authorized by the Kansas Commissioner of Insurance. The "Certificates of Insurance" shall include a clause requiring the insurer to notify Secretary thirty (30) calendar days in advance of a change in or cancellation of the insurance contracts.

10.3 Petitioner shall maintain the insurance required in Section 10.1 until the District Engineer releases the Petitioner from any Permit obligation.

11.0 DAMAGE TO UTILITIES: KDOT shall not be liable for damage to any utility not installed in the location authorized by any permit or agreement issued pursuant to the Utility Accommodation Policy.

12.0 PIPELINE LIABILITY: For attachments to bridges or other structures and for roadway crossings of PIPELINES CARRYING PETROLEUM, HAZARDOUS AND/OR CORROSIVE PRODUCTS, Petitioner shall solely assume all risk and liability for accidents and damages that may occur to persons, property or natural resources by reason of the operation of the pipeline attached to said bridge, structure or crossing of roadway.

12.1 Petitioner shall maintain the insurance required in Section 9.0 for as long as the pipeline remains attached to the bridge or other structure or for as long as the pipeline crosses the roadway. The insurance contract shall cover claims for such length of time as the law permits such claims.

13.0 ENVIRONMENTAL LIABILITY AND INDEMNIFICATION: Petitioner shall comply with all applicable federal, state, and local statutes, regulations and ordinances relating to environmental protection, and health and safety in Petitioner's acts on, or occupation of, the Highway right-of-way(s). Petitioner assumes all risk and liability for, or resulting from, any environmental condition on, at, or leaving the Highway(s) caused by or arising out of Petitioner's, or its agents' or contractors' acts, omissions, or occupation, in whole or in part, of the Highway right-of-way(s). Petitioner shall hold harmless and indemnify the Secretary against all liability, cost, expense, and fines incurred by or levied against the Secretary under any federal, state or local environmental law, regulation, or ordinance resulting from Petitioner's breach of this paragraph or as a result of Petitioner's acts or occupation of the Highway right-of-way(s) pursuant to this Permit. For purpose of this provision, the term Petitioner includes Petitioner's employees, agents, subcontractors (at any tier), suppliers (at any tier), successors and assigns.

14.0 HIGHWAY IMPROVEMENTS AND/OR MAINTENANCE: If Secretary makes any alteration or improvement along or upon the highway right-of-way which is the subject of this Permit, Petitioner shall hold Secretary harmless for any and all damage or injury to Petitioner's Facilities, whether finished or unfinished, as well as damage or injury to Petitioner's equipment, materials, employees, agents or contractees. Petitioner shall conduct all work approved on this permit in such a manner as not to interfere with construction or other work being performed by the KDOT (or City) or its contractors in the vicinity of Petitioner's work or project.

14.1 Within a reasonable time after receiving written notice from Secretary that Petitioner's Facilities are in conflict with KDOT's new construction or major maintenance operations, Petitioner shall alter, change location or move their construction work or Facilities without cost or expense to the Secretary. If Petitioner fails to relocate their Facilities within a reasonable time, KDOT may move the Facilities. Except for Rural Water Districts meeting the requirements of K.S. A. 68-415(c), Petitioner shall reimburse KDOT for the costs of relocating the Facilities upon receipt of an itemized statement. (See, K.S.A. 68-415). Petitioner shall reimburse KDOT for any construction costs, claims or expenses KDOT incurs as a result of Petitioner's failure to timely relocate the Facilities.

14.2 Written notice will not be required for KDOT's normal maintenance.

15.0 ABANDONED OR RETIRED IN PLACE: Petitioner shall notify Secretary when the Facilities will be abandoned or retired in place and shall submit a plan for abandonment or retirement in place to the District Engineer or designee for review and approval. Petitioner shall remove or abandon the Facilities in place in accordance with the approved plan. Petitioner shall pay all costs associated with removal of abandoned or retired in place upon highway right-of-way Facilities.

This Permit is hereby accepted and its provisions agreed to by the Parties.

APPROVED:

PETITIONER:

CITY OF

(when applicable)

Mayor City Mgr. City Engr.

City Clerk

City Contact Email

Signature

Printed Name

Street Address (City, State, Zip Code)

Agent Lessee Contractor

Street Address (City, State, Zip Code)

Contact Email

RECOMMENDED BY:

Area/Metro Engr. Area Supt. Utility Coord.

PERMIT APPROVAL:

SECRETARY OF TRANSPORTATION OF THE STATE OF KANSAS

BY:

District Engineer

Date

Const./Maint.
Petitioner
District
Area
City or Sub-Area

KANSAS DEPARTMENT OF TRANSPORTATION
Bureau of Construction and Maintenance

Permit No. _____
Route _____
Co. _____
State Highway _____
City Conn. Link _____
City _____

**HIGHWAY PERMIT
USE OF RIGHT OF WAY**

THIS AGREEMENT, made and entered into, between the Secretary of Transportation of the State of Kansas, referred to as "Secretary" and _____ (Name of Firm or Individual) (_____) (Tel. No.) _____ (Street) _____ (City) _____ (State) _____ (Zip) _____, referred to as "Petitioner" and the City of _____ (If Not Applicable, Enter N/A), referred to as "City".

Secretary has jurisdiction over highway right-of-ways within the State Highway System of Kansas, and

Secretary (and City) believe it is in the interest of the Citizens of the State of Kansas to permit certain work or projects to be performed upon Highway right-of-ways, and

Petitioner requests permission and authority from Secretary (and City) to perform certain work, described as follows:

**Void
See Revised Sheet
Rev. 12-18**

Said work is located on public right-of-way in, upon or along State Highway Route _____, Reference Point _____ (or City Connecting Link Route _____ or _____ St. in Sec. _____ Twp. _____ Range _____ County, _____ Miles(km) _____ (direction) from _____ (ct. or county line) and

Secretary has delegated full and complete authority to the District Engineers of the Kansas Department of Transportation (KDOT) to execute Highway Permit Agreements, referred to as "Permits," for and on Secretary's behalf.

In consideration of the permission granted by the Secretary (and City) to utilize Highway right-of-way(s) in the manner described above, the following terms and conditions are mutually agreed to by the Petitioner, the Secretary (and the City).

1.0 PLANS: Petitioner shall furnish five (5) sets of comprehensive plans or sketches, 8 1/2" x 11" or 11" x 17", of the proposed work.

1.1 Plans for utility installations must include a description of the size, type, and method of installation for the proposed Facilities to be located within highway right-of-ways, and adequate sketches to indicate the location of the proposed installation with respect to the traveled way of the highway, the right-of-way lines and, where applicable, the control of access lines,

1.2 An accurate "As Built" Construction Plan shall be provided for deviation from the approved Plan.

2.0 MATERIAL AND METHODS: All requests to perform work in, upon or along Highway right-of-ways must be approved by the District Engineer (and City). In Cities, Petitioner will obtain additional Permits, as required by City.

2.1 The Petitioner shall furnish all material, do all work and pay all costs for the work described on this Permit,

2.2 All utility installations shall comply with the conditions and applicable requirements of the KDOT Utility Accommodation Policy, current edition, which is incorporated by reference in its entirety (and City standards when they exceed those of KDOT).

2.3 Drainage structure requirements shall be determined by Petitioner, but requirements are subject to review and approval by the District Engineer (and City).

2.4 All materials and construction methods used on work within the limits of the right-of-way shall meet or exceed the requirements of the "Standard Specifications for State Road and Bridge Construction," current edition. The Standard Specifications are available at www.ksdot.org.

3.0 INITIATION AND COMPLETION OF WORK: Petitioner agrees to notify the District Engineer (and City) or their duly authorized

KDOT representative _____ before work is initiated and again when the work is completed.

3.1 An approved signed copy of this Permit shall be on the premises at the start and during the period any work is performed.

3.2 All-work, including right-of-way restoration, shall be completed within _____ calendar days of APPROVAL DATE, otherwise this Permit is rescinded. If work has not been started within the completion time, this Permit becomes null and void.

4.0 INSPECTION: Petitioner will be responsible for supervising construction to insure compliance with KDOT (and City) policies and standards.

5.0 ACCEPTANCE: (Check One) KDOT ; City ; will be responsible for acceptance of restored right-of-way.

6.0 RIGHT-OF-WAY: Except for authorized changes, Petitioner shall restore the right-of-way to a condition equal to or better than existed prior to approval of the work described on this Permit.

6.1 Any sod, shrubs or trees destroyed by this work shall be replaced as directed by the District Engineer (and City).

6.2 The right-of-way shall be kept free from parking, advertising signs or any other commercial activity.

7.0 OBSTRUCTION OF TRAFFIC: Petitioner shall ensure highway (and connecting link) traffic will be free of interference unless specifically provided for as a part of this Permit. All temporary traffic control devices and their installation and maintenance shall comply with the latest edition of the Manual on Uniform Traffic Control Devices (MUTCD for streets and highways which has been adopted by the Secretary). Whenever the temporary Traffic Control Standards conflict with the MUTCD, the Standards shall govern. Workers shall wear approved safety vests according to 23 CFR Part 634, Worker Visibility.

8.0 MAINTENANCE: All utility installations shall be maintained or caused to be maintained by Petitioner.
 9.0 PERMIT REVOCATION: In lieu of bond, Secretary may revoke the permit and remove any work performed. The Petitioner shall reimburse the Secretary for any cost incurred by Secretary to restore the right-of-way. The Secretary will not authorize any other highway permits until Petitioner has either reimbursed Secretary or restored the right-of-way.

10.0 LIABILITY: Petitioner shall indemnify and hold harmless Secretary from personal injury and property damage claims arising out of any act or omission of Petitioner. If Secretary defends a third party's claim, the Petitioner shall indemnify Secretary for personal injury damages, property damages and related expenses Secretary incurs arising out of Petitioner's act or omission. For purposes of this provision, the term Petitioner includes Petitioner's employees, agents, subcontractors (at any tier), suppliers (at any tier), successors, and assigns.

10.1 INSURANCE: Liability Insurance. Petitioner shall carry "General Liability" insurance under an occurrence policy that has a minimum combined single limit of \$2,000,000 for personal injury and property damage and that contains the following coverage: Comprehensive Form, Premises-Operation, Underground Hazard, Products/Completed Operations Hazard, Contractual Insurance, Broad form Property Damage, Independent Contractors, and Personal Injury. Worker's Compensation: Petitioner shall carry "Worker's Compensation and Employer's Liability" insurance that complies with Kansas Statute. Automobile Liability: Petitioner shall carry "Automobile Liability" insurance under an occurrence policy that has a minimum combined single limit of \$1,000,000.00 for personal injury and property damage and that contains the following coverage: Comprehensive Form, Owned, Hired, and Non-Owned.

10.2 "Certificate of Insurance". This permit shall not take effect unless Petitioner provides Secretary a "Certificates of Insurance" confirming Petitioner carries insurance in the amounts and type this section requires. Petitioner shall obtain insurance only from insurers on the approved Federal Treasury List and authorized by the Kansas Commissioner of Insurance. The "Certificates of Insurance" shall include a clause requiring the insurer to notify Secretary thirty (30) calendar days in advance of a change in or cancellation of the insurance contracts.

10.3 Petitioner shall maintain the insurance required in Section 10.1 until the District Engineer releases the Petitioner from any Permit obligation.

11.0 DAMAGE TO UTILITIES: KDOT shall not be liable for damage to any utility not installed in the location authorized by any permit or agreement issued pursuant to the Utility Accomodation Policy.

12.0 PIPELINE LIABILITY: For attachments to bridges or other structures and for roadway crossings of PIPELINES CARRYING PETROLEUM, HAZARDOUS AND/OR CORROSIVE PRODUCTS, Petitioner shall solely assume all risk and liability for accidents and damages that may occur to persons, property or natural resources by reason of the operation of the pipeline attached to said bridge, structure or crossing of roadway.

12.1 Petitioner shall maintain the insurance required in Section 9.0 for as long as the pipeline remains attached to the bridge or other structure or for as long as the pipeline crosses the roadway. The insurance contract shall cover claims for such length of time as the law permits such claims.

13.0 ENVIRONMENTAL LIABILITY AND INDEMNIFICATION: Petitioner shall assume all risk and liability for all claims suits, actions, causes of actions, demands, rights, damages, costs, expenses, penalties, fines or compensation whatsoever, direct or indirect, which Petitioner now has or which Petitioner may have in the future on account of or arising out of or in connection with any known or unknown physical or environmental condition of the Petitioner's property or operation. Petitioner shall comply with federal, state and local statutes, rules and regulations. These include, without limitation, the Toxic Substances Control Act, the Comprehensive Environmental Response, Compensation and Liability Act, the Clean Water Act, the Oil Pollution Act, the Federal Drinking Water Act, the Clean Air Act, the Resource Conservation Recovery Act, and the state analogs. Petitioner shall indemnify the Secretary against and from all damages, expenses and costs incurred by any person, the State of Kansas, or the United States Government for determining and undertaking investigation, clean-up, removal or remedial action, any fines or penalties assessed under state or federal laws, contract claims, personal injury claims, and damage of or loss of natural resources. For purposes of this provision, the term Petitioner includes Petitioner's employees, agents, subcontractors (at any tier), suppliers (at any tier), successors, and assigns.

14.0 HIGHWAY IMPROVEMENTS AND/OR MAINTENANCE: If Secretary makes any alteration or improvement along or upon the highway right-of-way which is the subject of this Permit, Petitioner shall hold Secretary harmless for any and all damage or injury to Petitioner's Facilities, whether finished or unfinished, as well as damage or injury to Petitioner's equipment, materials, employees, agents or contractors. Petitioner shall conduct all work approved on this permit in such a manner as not to interfere with construction or other work being performed by the KDOT (or City) or its contractors in the vicinity of Petitioner's work or project.

14.1 Within a reasonable time after receiving written notice from Secretary that Petitioner's Facilities are in conflict with KDOT's new construction or major maintenance operations, Petitioner shall alter, change location or move their construction work or Facilities without cost or expense to the Secretary. If Petitioner fails to relocate their Facilities within a reasonable time, KDOT may move the Facilities. Except for Rural Water Districts meeting the requirements of K.S.A. 68-415(c), Petitioner shall reimburse KDOT for the costs of relocating the Facilities upon receipt of an itemized statement. (See, K.S.A. 68-415). Petitioner shall reimburse KDOT for any construction costs, claims or expenses KDOT incurs as a result of Petitioner's failure to timely relocate the Facilities.

14.2 Written notice will not be required for KDOT's normal maintenance.

15.0 ABANDONED OR RETIRED IN PLACE: Petitioner shall notify Secretary when the Facilities will be abandoned or retired in place and shall submit a plan for abandonment or retirement in place to the District Engineer or designee for review and approval. Petitioner shall remove or abandon the Facilities in place in accordance with the approve plan. Petitioner shall pay all costs associated with removal of abandoned or retired in place upon highway right-of-way Facilities.

This Permit is hereby accepted and its provisions agreed to by the Parties.

APPROVED: CITY OF _____ (when applicable) <input type="checkbox"/> Mayor <input type="checkbox"/> City Mgr. <input type="checkbox"/> City Engr. <input type="checkbox"/> _____ City Clerk	PETITIONER: <input type="text"/> Signature _____ Printed Name _____ Street Address (City, State, Zip Code) _____ <input type="checkbox"/> Agent <input type="checkbox"/> Lesse <input type="checkbox"/> Contractor _____ Street Address (City, State, Zip Code) _____ Contact Email
--	---

RECOMMENDED BY: _____
 Area/Metro Engr. Area Supt. Utility Coord.

PERMIT APPROVAL DATE: _____

SECRETARY OF TRANSPORTATION
 OF THE STATE OF KANSAS

BY:
 District Engineer

CASED UTILITY LINE WAIVER

REQUIRED COMPLIANCE FOR WAIVER OF CASED LINE CERTIFICATION

The undersigned, in applying for joint use of highway right-of-way, has requested the waiver of cased lines as required by the Kansas Department of Transportation Utility Accommodation Policy (UAP). The undersigned acknowledges that approval of this waiver by the Kansas Department of Transportation (KDOT) is conditioned upon the undersigned's execution of this certification.

I hereby certify that I am a duly authorized representative of the _____
_____ (Utility), and the Utility and I represent that the line qualifies for a waiver of casing as the line complies with the conditions and provisions contained in the items below:

- a. Welded steel pipelines.
- b. Cathodically protected.
- c. Coated in accordance with accepted industry standards.
- d. Meets requirements of the Pipeline Safety Regulations-Code of Federal Regulations-Title 49-Transportation (Part 191 and 192-Natural Gas) or (Part 195-Liquid Petroleum Gas) with respect to wall thickness.
- e. Designed for operating stress levels in accordance with Federal Pipeline Safety Regulations.

I acknowledge that this certificate, which is factual and reliable, is furnished to KDOT in connection with this request for joint use of highway right-of-way and is subject to State and Federal laws, both criminal and civil.

By: _____

Name of Utility: _____

Address: _____

Date: .

Permit or Agreement No. .

Distribution:
Maint.
Petitioner
District
Area

CASED UTILITY LINE WAIVER
REQUIRED COMPLIANCE FOR WAIVER
OF CASED LINE CERTIFICATION

The undersigned, in applying for joint use of highway right-of-way, has requested the waiver of cased lines as required by the Kansas Department of Transportation Utility Accommodation Policy (UAP). The undersigned acknowledges that approval of this waiver by the Kansas Department of Transportation (KDOT) is conditioned upon the undersigned's execution of this certification.

I hereby certify that I am a duly authorized representative of the _____
_____ (Utility), and the Utility and I represent that the line qualifies for a waiver of casing as the line complies with the conditions and provisions contained in the items below:

- a. Welded steel pipelines.
- b. Cathodically protected.
- c. Coated in accordance with accepted industry standards.
- d. Meets requirements of the Pipeline Safety Regulations—Code of Federal Regulations—Title 49—Transportation (Part 191 and 192—Natural Gas) or (Part 195—Liquid Petroleum Gas) with respect to wall thickness.
- e. Designed for operating stress levels in accordance with Federal Pipeline Safety Regulations.

Void
See Revised Sheet
Rev. 11-15

I acknowledge that this certificate, which is factual and reliable, is furnished to KDOT in connection with this request for joint use of highway right-of-way and is subject to State and Federal laws, both criminal and civil.

By: _____

Name of Utility: _____

Address: _____

Date: _____

Permit or Agreement No. _____

- Distribution:
- Const/Maint
 - Petitioner
 - District
 - Area

(This Page Intentionally Left Blank)

Maint.
Design-Br. Sect.
Petitioner
District
Area
City or Sub-Area

KANSAS DEPARTMENT OF TRANSPORTATION
Bureau of Maintenance
HIGHWAY PERMIT

Permit No. _____
Route _____
Co. _____
Br. Ser. No. _____
R/W Permit No. _____
(for work approaching bridge)

**ATTACHMENTS TO BRIDGES
AND OTHER STRUCTURES OR INSTALLATIONS
NEAR RETAINING WALL SYSTEMS**

THIS AGREEMENT, made and entered into this _____ day of _____, 20____, by and between the Secretary of Transportation of the State of Kansas, referred to as "Secretary," and _____ (Name of Firm or Individual), referred to as "Owner," and _____ (Telephone No.), _____ (Street), _____ (City), as Agent, Lessee or Contractor of the Owner, referred to as "Agent". Owner and Agent are referred to collectively as "Petitioner," where both are applicable, otherwise Petitioner shall refer to Owner.

Secretary has jurisdiction over and control of all bridges and other structures on the State Highway System of Kansas, and Secretary believes that it is in the interest of the Citizens of the State of Kansas to allow public or private utilities to utilize bridges or other structures on the State Highway System under certain circumstances, and Petitioner requests permission and authority from Secretary to construct and maintain a _____ (Describe: size, type and location on the bridge)

attached to (Bridge, Structure) Serial No. _____ on Highway Route _____ in _____ County, Kansas at Reference Point _____, a part of the State Highway System, and

Secretary has delegated full and complete authority to the District Engineers of the Kansas Department of Transportation (KDOT) to execute Highway Permit Agreements, referred to as "Permits," for and on Secretary's behalf.

In consideration of the permission granted by Secretary to utilize a bridge or structure or installation near a retaining wall system in the manner described above, Petitioner agrees to the following terms and conditions:

1.0 PLANS: Petitioner shall furnish two (2) sets of comprehensive plan sets or detailed drawings 11" x 17", and/or electronic pdf copy of the proposed work. Sketches, cut sheets, and/or documentation may be submitted on 8 1/2"x 11". Plans or detailed drawings must indicate the size, type, and nominal weight of the proposed installation, and include details of the location, method of attachment and type of attaching hardware or method of installation as applicable.

2.0 DESIGN FOR ATTACHMENTS: A check in the amount of \$ _____ dollars, made payable to the Kansas Department of Transportation is required from Petitioner for payment of additional structure cost to support the Utility Installation.

3.0 MATERIAL AND METHODS: Petitioner shall furnish all material, do all work, and pay all costs for the work described on this Permit.

3.1 All proposals for Utility Installations and other attachments to bridges or structures or installation near a retaining wall system must be pre-approved in writing by the Bureau of Design, Bridge Section and the District Engineer.

3.2 All attachments to bridges or other structures or installation near retaining wall systems shall comply with the conditions and requirements of the "Utility Accommodation Policy for KDOT", current edition which is herein incorporated by reference in its entirety.

3.3 All materials and construction methods used on work within the limits of the right-of-way shall be equal to or better than that required by the Standard Specifications for State Road and Bridge Construction, current edition.

4.0 OBSTRUCTION OF TRAFFIC: Petitioner shall ensure highway (and connecting link) traffic will be free of interference unless specifically provided for as a part of this Permit. All temporary traffic control devices and their installation and maintenance shall comply with the latest edition of the Manual on Uniform Traffic Control Devices (MUTCD) for streets and highways which has been adopted by the Secretary. Whenever the Temporary Traffic Control Standards conflict with the MUTCD, the Standards shall govern. Workers shall wear approved safety vests according to 23 CFR Part 634, Worker Visibility.

5.0 Right-of-Way. Petitioner shall restore the right-of-way to the condition existing prior to approval of the work described on this Permit.

5.1 Any sod, shrubs or trees destroyed by this work shall be replaced as directed by the District Engineer.

5.2 The right-of-way shall be kept free from parking, advertising signs or any other commercial activity.

6.0 MAINTENANCE: All Utility Installations shall be maintained or caused to be maintained by Petitioner.

7.0 PERMIT REVOCATION: In lieu of bond, Secretary may revoke the Permit and remove any work-performed. Petitioner shall reimburse Secretary for any cost incurred by Secretary to restore the right-of-way. Secretary will not authorize any other highway permits until the Petitioner has either reimbursed the Secretary or restored the right-of-way.

8.0 INTIATION AND COMPLETION OF WORK: Petitioner agrees to notify the District Engineer (and City) or their duly authorized KDOT representative _____ before work is initiated and again when the work is completed.

8.1 An approved signed copy of this Permit shall be on the premises at the start and during the period any work is performed.

8.2 All work, including right-of-way restoration, shall be completed within _____ calendar days of APPROVAL DATE, otherwise this Permit is null and void. The District Engineer or his duly authorized representative may grant an extension of time upon request of Petitioner. Any such request must be submitted in writing and state the reasons for delay in completing the work.

9.0 LIABILITY: Petitioner shall indemnify and hold harmless Secretary from personal injury and property damage claims arising out of any act or omission of Petitioner. If Secretary defends a third party's claim, Petitioner shall indemnify Secretary for personal injury damages, property damages, and related expenses Secretary incurs arising out of Petitioner's act or omission. For purposes of this provision, the term Petitioner includes Petitioner's employees, agents, subcontractors (at any tier), suppliers (at any tier), successors, and assigns.

9.1 INSURANCE: Liability Insurance. Petitioner shall carry "General Liability" insurance under an occurrence policy that has a minimum combined single limit of \$2,000,000 for personal injury and property damage and that contains the following coverage: Comprehensive Form, Premises-Operation, Underground Hazard, Products/Completed Operations Hazard, Contractual Insurance, Broad form Property Damage, Independent Contractors, and Personal Injury. Worker's Compensation. Petitioner shall carry "Worker's Compensation and Employer's Liability" insurance that complies with Kansas state law. Automobile Liability. Petitioner shall carry "Automobile Liability" insurance under an occurrence policy that has a minimum combined single limit of \$1,000,000.00 for personal injury and property damage and that contains the following coverage: Comprehensive Form, Owned, Hired, and Non-Owned.

9.2 "Certificate of Insurance". This Permit shall not take effect unless Petitioner provides Secretary a "Certificates of Insurance" confirming Petitioner carries insurance in the amounts and type this section requires. Petitioner shall obtain insurance only from insurers on the approved Federal Treasury List and authorized by the Kansas Commissioner of Insurance. The "Certificates of Insurance" shall include a clause requiring the insurer to notify the Secretary thirty (30) days in advance of cancellation of the insurance contracts.

9.3 Petitioner shall maintain this insurance until the District Engineer releases Petitioner from any Permit obligation.

10.0 DAMAGE TO UTILITIES: KDOT shall not be liable for damage to any utility not installed in the location authorized by any permit or agreement issued pursuant to the Utility Accommodation Policy.

11.0 PIPELINE LIABILITY: For attachments to bridges or other structures and for roadway crossings of PIPELINES CARRYING PETROLEUM, HAZARDOUS AND/OR CORROSIVE PRODUCTS, Petitioner shall solely assume all risk and liability for accidents and damages that may occur to persons, property or natural resources by reason of the operation of the pipeline attached to the bridge or structure or crossing the roadway.

11.1 Petitioner shall maintain the insurance required in Section 9.0 for as long as the pipeline remains attached to the bridge or other structure or for as long as the pipeline crosses the roadway. The insurance contract shall cover claims for such length of time as the law permits such claims.

12.0 ENVIRONMENTAL LIABILITY AND INDEMNIFICATION: Petitioner shall comply with all applicable federal, state, and local statutes, regulations and ordinances relating to environmental protection, and health and safety in Petitioner's acts on, or occupation of, the Highway right-of-way(s). Petitioner assumes all risk and liability for, or resulting from, any environmental condition on, at, or leaving the Highway(s) caused by or arising out of Petitioner's, or its agents' or contractors' acts, omissions, or occupation, in whole or in part of the Highway right-of-way(s). Petitioner shall hold harmless and indemnify the Secretary against all liability, cost, expense, and fines incurred by or levied against the Secretary under any federal, state or local environmental law, regulation, or ordinance resulting from Petitioner's breach of this paragraph or as a result of Petitioner's acts or occupation of the Highway right-of-way(s) pursuant to this Permit. For purpose of this provision, the term Petitioner includes Petitioner's employees, agents, subcontractors (at any tier), suppliers (at any tier), successors and assigns.

13.0 HIGHWAY IMPROVEMENTS: If Secretary makes any alteration or improvement along or upon the highway right-of-way which is the subject of this Permit, Petitioner agrees to hold Secretary harmless for any and all damages or injury to said Petitioner's construction, whether finished or unfinished, as well as damage or injury to Petitioner's equipment, materials, employees, agents or contractees. Within a reasonable time after receiving written notice from Secretary that Petitioner's facilities are in conflict with KDOT's new construction or major maintenance operations, Petitioner shall alter, change location or move their construction work or facilities without cost or expense to the Secretary. If Petitioner fails to relocate their Facilities within a reasonable time, KDOT may designate a time which is not arbitrary or capricious for moving the Facilities. Petitioner shall reimburse KDOT for the costs of relocating the Facilities upon receipt of an itemized statement. (K.S.A. 68-415). In the alternative, Petitioner shall reimburse KDOT for any damages or liabilities or costs to accelerate it may incur as a result of Petitioner's failure to timely relocate the Facility.

13.1 Work approved on this Permit will be conducted in a manner as not to interfere with construction work being performed by KDOT or it's contractors in the vicinity of Petitioner's work or project.

14.0 CANCELLATION: This Permit may be terminated or cancelled by either party upon thirty (30) days written notice to the other party and all rights and privileges accrued to Petitioner under the terms of this Permit shall cease forever, and upon termination or cancellation of this Permit Petitioner shall remove the attachments to the bridge or structure without damage or injury to the bridge or structure. Petitioner shall reimburse the Secretary for any and all damages or injury which results from the removal of attachments to the bridge or structure within thirty (30) days of receipt of an itemized statement of damages.

15.0 ABANDONED OR RETIRED IN PLACE: Petitioner shall notify Secretary when the Facilities will be abandoned or retired in place and shall submit a plan for abandonment or retirement in place to the District Engineer or designee for review and approval. Petitioner shall remove or abandon the Facilities in place in accordance with the approve plan. Petitioner shall pay all costs associated with removal of abandoned or retired in place upon highway right-of-way Facilities.

Emergency Contact (24/7)

This Permit is hereby accepted and its provisions agreed to by the parties.

Signature	
Printed Name	
Owner	Phone
Street Address (City, State, Zip Code)	Date
<input type="checkbox"/> Agent <input type="checkbox"/> Lessee <input type="checkbox"/> Contractor	Title
Street Address (City, State, Zip Code)	Date
Recommended _____	Area/Metro Engr. Area Supt. Utility Coord.
Date	
Approved _____	Bureau of Design-Bridge Section
Date	
Permit approved this _____ day of _____, 20_____	

SECRETARY OF TRANSPORTATION
OF THE STATE OF KANSAS

BY _____
District Engineer

Maint.
Design-Br. Sect.
Petitioner
District
Area
City or Sub-Area

KANSAS DEPARTMENT OF TRANSPORTATION

Bureau of Maintenance

HIGHWAY PERMIT

Permit No. _____

Route _____

Co. _____

Br. Ser. No. _____

R/W Permit No. _____
(for work approaching bridge)

ATTACHMENTS TO BRIDGES
AND OTHER STRUCTURES OR INSTALLATIONS
NEAR RETAINING WALL SYSTEMS

THIS AGREEMENT, made and entered into this _____ day of _____, 20____, by and between the Secretary of Transportation of the State of Kansas, referred to as "Secretary," and _____

(Name of Firm or Individual)

_____, referred to as "Owner," and _____

(Telephone No.)

(Street)

(City)

_____, as Agent, Lessee

(Name-if not applicable, enter N/A)

(Street No.)

(City)

or Contractor of the Owner, referred to as "Agent". Owner and Agent are referred to collectively as "Petitioner," where both are applicable, otherwise Petitioner shall refer to Owner.

Secretary has jurisdiction over and control of all bridges and other structures on the State Highway System of Kansas, and Secretary believes that it is in the interest of the Citizens of the State of Kansas to allow public or private utilities to utilize bridges or other structures on the State Highway System under certain circumstances, and

Petitioner requests permission and authority from Secretary to construct and maintain a _____

(Describe: size, type and location on the bridge)

attached to (Bridge, Structure) Serial No. _____ on Highway Route _____ in _____ County, Kansas

at Reference Point _____, a part of the State Highway System, and

Secretary has delegated full and complete authority to the District Engineers of the Kansas Department of Transportation (KDOT) to execute Highway Permit Agreements, referred to as "Permits," for and on Secretary's behalf.

In consideration of the permission granted by Secretary to utilize a bridge or structure or installation near a retaining wall system in the manner described above, Petitioner agrees to the following terms and conditions:

1.0 PLANS: Petitioner shall furnish two (2) sets of comprehensive plans or detailed drawings, 8 1/2" x 11" or 11" x 17", or electronic pdf copy of the proposed work. Plans or detailed drawings must indicate the size, type, and nominal weight of the proposed installation, and include details of the location, method of attachment and type of attaching hardware or method of installation as applicable.

2.0 DESIGN FOR ATTACHMENTS: A check in the amount of \$ _____ dollars, made payable to the Kansas Department of Transportation is required from Petitioner for payment of additional structure cost to support the Utility Installation.

3.0 MATERIAL AND METHODS: Petitioner shall furnish all material, do all work, and pay all costs for the work described on this Permit.

3.1 All proposals for Utility Installations and other attachments to bridges or structures or installation near a retaining wall system must be pre-approved in writing by the Bureau of Design, Bridge Section and the District Engineer.

3.2 All attachments to bridges or other structures or installation near retaining wall systems shall comply with the conditions and requirements of the "Utility Accommodation Policy for KDOT", current edition which is herein incorporated by reference in its entirety.

3.3 All materials and construction methods used on work within the limits of the right-of-way shall be equal to or better than that required by the Standard Specifications for State Road and Bridge Construction, current edition.

4.0 OBSTRUCTION OF TRAFFIC: Petitioner shall insure highway (and connecting link) traffic will be free of interference unless specifically provided for as a part of this Permit. All temporary traffic control devices and their installation and maintenance shall comply with the latest edition of the Manual on Uniform Traffic Control Devices (MUTCD) for streets and highways which has been adopted by the Secretary. Whenever the Temporary Traffic Control Standards conflict with the MUTCD, the Standards shall govern. Workers shall wear approved safety vests according to 23 CFR Part 634, Worker Visibility.

5.0 Right-of-Way. Petitioner shall use the right-of-way to the condition existing prior to approval of the work described on this Permit.

5.1 Any sod, shrubs or trees destroyed by this work shall be replaced as directed by the District Engineer.

5.2 The right-of-way shall be kept free from parking, advertising signs or any other commercial activity.

6.0 MAINTENANCE: All Utility Installations shall be maintained or caused to be maintained by Petitioner.

7.0 PERMIT REVOCATION: In lieu of bond, Secretary may revoke the Permit and remove any work-performed. Petitioner shall reimburse Secretary for any cost incurred by Secretary to restore the right-of-way. Secretary will not authorize any other highway permits until the Petitioner has either reimbursed the Secretary or restored the right-of-way.

8.0 INTIATION AND COMPLETION OF WORK: Petitioner agrees to notify the District Engineer (and City) or their duly authorized KDOT representative _____

before work is initiated and again when the work is completed.

8.1 An approved signed copy of this Permit shall be on the premises at the start and during the period any work is performed.

8.2 All work, including right-of-way restoration, shall be completed within _____ calendar days of APPROVAL DATE, otherwise this Permit is null and void. The District Engineer or his duly authorized representative may grant an extension of time upon request of Petitioner. Any such request must be submitted in writing and state the reasons for delay in completing the work.

9.0 LIABILITY: Petitioner shall indemnify and hold harmless Secretary from personal injury and property damage claims arising out of any act or omission of Petitioner. If Secretary defends a third party's claim, Petitioner shall indemnify Secretary for personal injury damages, property damages, and related expenses Secretary incurs arising out of Petitioner's act or omission. For purposes of this provision, the term Petitioner includes Petitioner's employees, agents, subcontractors (at any tier), suppliers (at any tier), successors, and assigns.

9.1 INSURANCE: Liability Insurance. Petitioner shall carry "General Liability" insurance under an occurrence policy that has a minimum combined single limit of \$2,000,000 for personal injury and property damage and that contains the following coverage: Comprehensive Form, Premises-Operation, Underground Hazard, Products/Completed Operations Hazard, Contractual Insurance, Broad form Property Damage, Independent Contractors, and Personal Injury. Worker's Compensation. Petitioner shall carry "Worker's Compensation and Employer's Liability" insurance that complies with Kansas state law. Automobile Liability. Petitioner shall carry "Automobile Liability" insurance under an occurrence policy that has a minimum combined single limit of \$1,000,000.00 for personal injury and property damage and that contains the following coverage: Comprehensive Form, Owned, Hired, and Non-Owned.

9.2 "Certificate of Insurance". This Permit shall not take effect unless Petitioner provides Secretary a "Certificates of Insurance" confirming Petitioner carries insurance in the amounts and type this section requires. Petitioner shall obtain insurance only from insurers on the approved Federal Treasury List and authorized by the Kansas Commissioner of Insurance. The "Certificates of Insurance" shall include a clause requiring the insurer to notify the Secretary thirty (30) days in advance of a change in or cancellation of the insurance contracts.

9.3 Petitioner shall maintain this insurance until the District Engineer releases Petitioner from any Permit obligation.

10.0 DAMAGE TO UTILITIES: KDOT shall not be liable for damage to any utility not installed in the location authorized by any permit or agreement issued pursuant to the Utility Accommodation Policy.

11.0 PIPELINE LIABILITY: For attachments to bridges or other structures and for roadway crossings of PIPELINES CARRYING PETROLEUM, HAZARDOUS AND/OR CORROSIVE LIQUIDS, Petitioner shall solely assume all risk and liability for accidents and damages that may occur to persons, property or natural resources by reason of the operation of the pipeline attached to the bridge or structure or crossing the roadway.

11.1 Petitioner shall maintain the insurance required in Section 9.0 for as long as the pipeline remains attached to the bridge or other structure or for as long as the pipeline crosses the roadway. The insurance coverage shall cover claims for such length of time as the law permits such claims.

12.0 ENVIRONMENTAL LIABILITY AND INDEMNIFICATION: Petitioner shall comply with all applicable federal, state, and local statutes, regulations and ordinances relating to environmental protection and health and safety in Petitioner's acts or occupation of the Highway right-of-way(s). Petitioner assumes all risk and liability for, or resulting from, any environmental condition on, at, or leaving the Highway(s) caused by or arising out of Petitioner's, or its agents' or contractors' acts, omissions, or occupation, in whole or in part of the Highway right-of-way(s). Petitioner shall hold harmless and indemnify the Secretary against all liability, cost, expense, and fines incurred by or levied against the Secretary under any federal, state or local environmental law, regulation, or ordinance resulting from Petitioner's breach of this paragraph or as a result of Petitioner's acts or occupation of the Highway right-of-way(s) pursuant to this Permit. For purpose of this provision, the term Petitioner includes Petitioner's employees, agents, subcontractors (at any tier), suppliers (at any tier), successors and assigns.

13.0 HIGHWAY IMPROVEMENTS: If Secretary makes any alteration or improvement along or upon the highway right-of-way which is the subject of this Permit, Petitioner agrees to hold Secretary harmless for any and all damages or injury to said Petitioner's construction, whether finished or unfinished, as well as damage or injury to Petitioner's equipment, materials, employees, agents or contractees. Within a reasonable time after receiving written notice from Secretary that Petitioner's facilities are in conflict with KDOT's new construction or major maintenance operations, Petitioner shall alter, change location or move their construction work or facilities without cost or expense to the Secretary. If Petitioner fails to relocate their Facilities within a reasonable time, KDOT may designate a time which is not arbitrary or capricious for moving the Facilities. Petitioner shall reimburse KDOT for the costs of relocating the Facilities upon receipt of an itemized statement. (K.S.A. 68-415). In the alternative, Petitioner shall reimburse KDOT for any damages or liabilities or costs to accelerate it may incur as a result of Petitioner's failure to timely relocate the Facility.

13.1 Work approved on this Permit will be conducted in a manner as not to interfere with construction work being performed by KDOT or it's contractors in the vicinity of Petitioner's work or project.

14.0 CANCELLATION: This Permit may be terminated or cancelled by either party upon thirty (30) days written notice to the other party and all rights and privileges accrued to Petitioner under the terms of this Permit shall cease forever, and upon termination or cancellation of this Permit Petitioner shall remove the attachments to the bridge or structure without damage or injury to the bridge or structure. Petitioner shall reimburse the Secretary for any and all damages or injury which results from the removal of attachments to the bridge or structure within thirty (30) days of receipt of an itemized statement of damages.

15.0 ABANDONED OR RETIRED IN PLACE: Petitioner shall notify Secretary when the Facilities will be abandoned or retired in place and shall submit a plan for abandonment or retirement in place to the District Engineer or designee for review and approval. Petitioner shall remove or abandon the Facilities in place in accordance with the approve plan. Petitioner shall pay all costs associated with removal of abandoned or retired in place upon highway right-of-way Facilities.

Emergency Contact (24/7)

This Permit is hereby accepted and its provisions agreed to by the parties.

Signature

Printed Name

Owner

Phone

Date

Street Address (City, State, Zip Code)

Agent Lessee Contractor

Title

Date

Street Address (City, State, Zip Code)

Contact Email

Recommended _____
Date

Area/Metro Engr. Area Supt. Utility Coord.

Approved _____
Date

Bureau of Design-Bridge Section

Permit approved this _____ day of _____, 20____

SECRETARY OF TRANSPORTATION
OF THE STATE OF KANSAS

BY _____
District Engineer

Const./Maint.
Design-Br. Sect.
Petitioner
District
Area
City or Sub-Area

KANSAS DEPARTMENT OF TRANSPORTATION
Bureau of Construction and Maintenance

Permit No. _____
Route _____
Co. _____
Br. Ser. No. _____
R/W Permit No. _____
(for work approaching bridge)

HIGHWAY PERMIT
ATTACHMENTS TO BRIDGES
AND OTHER STRUCTURES OR INSTALLATIONS
NEAR RETAINING WALL SYSTEMS

THIS AGREEMENT, made and entered into this _____ day of _____, 20____, by and between the Secretary of Transportation of the State of Kansas, referred to as "Secretary," and _____ (Name of Firm or Individual), referred to as "Owner," and _____ (Telephone No.), _____ (Street), _____ (City), as Agent, Lessee or Contractor of the Owner, referred to as "Agent". Owner and Agent are referred to collectively as "Petitioner," where both are applicable, otherwise Petitioner shall refer to Owner.

Secretary has jurisdiction over and control of all bridges and other structures on the State Highway System of Kansas, and Secretary believes that it is in the interest of the Citizens of the State of Kansas to allow public or private utilities to utilize bridges or other structures on the State Highway System under certain circumstances, and Petitioner requests permission and authority from Secretary to construct and maintain a _____ (Describe: size, type and location on the bridge)

attached to (Bridge, Structure) Serial No. _____ on Highway Route _____ in _____ County, Kansas at Reference Point _____, a part of the State Highway System, and

Secretary has delegated full and complete authority to the District Engineers of the Kansas Department of Transportation (KDOT) to execute Highway Permit Agreements, referred to as "Permits," for and on Secretary's behalf.

In consideration of the permission granted by Secretary to utilize a bridge or structure or installation near a retaining wall system in the manner described above, Petitioner agrees to the following terms and conditions:

1.0 PLANS: Petitioner shall furnish six (6) sets of comprehensive plans or sketches, 8 1/2" x 11" or 11" x 17", of the proposed work. Plans or sketches must indicate the size, type, and nominal weight of the proposed installation, and include details of the location, method of attachment and type of attaching hardware or method of installation as applicable.

2.0 DESIGN FOR ATTACHMENTS: A check in the amount of \$ _____ dollars, made payable to the Kansas Department of Transportation is required from Petitioner for payment of additional structure cost to support the Utility Installation.

3.0 MATERIAL AND METHODS: Petitioner shall furnish all material, do all work, and pay all costs for the work described on this Permit.
3.1 All proposals for Utility Installations and other attachments to bridges or structures or installation near a retaining wall system must be pre-approved in writing by the Bureau of Design, Bridge Section and the District Engineer.

3.2 All attachments to bridges or other structures or installation near retaining wall systems shall comply with the conditions and requirements of the "Utility Accommodation Policy for KDOT", current edition which is herein incorporated by reference in its entirety.

3.3 All materials and construction methods used on work within the limits of the right-of-way shall be equal to or better than that required by the Standard Specifications for State Road and Bridge Construction, current edition.

4.0 OBSTRUCTION OF TRAFFIC: Petitioner shall ensure highway (and connecting link) traffic will be free of interference unless specifically provided for as a part of this Permit. All temporary traffic control devices and their installation and maintenance shall comply with the latest edition of the Manual on Uniform Traffic Control Devices (MUTCD) for streets and highways which has been adopted by the Secretary. Whenever the Temporary Traffic Control Standards conflict with the MUTCD, the Standards shall govern. Workers shall wear approved safety vests according to 23 CFR Part 634, Worker Visibility.

5.0 Right-of-Way. Petitioner shall restore the right-of-way to the condition existing prior to approval of the work described on this Permit.

5.1 Any sod, shrubs or trees destroyed by this work shall be replaced as directed by the District Engineer.

5.2 The right-of-way shall be kept free from parking, advertising signs or any other commercial activity.

6.0 MAINTENANCE: All Utility Installations shall be maintained or caused to be maintained by Petitioner.

7.0 PERMIT REVOCATION: In lieu of bond, Secretary may revoke the Permit and remove any work-performed. Petitioner shall reimburse Secretary for any cost incurred by Secretary to restore the right-of-way. Secretary will not authorize any other highway permits until the Petitioner has either reimbursed the Secretary or restored the right-of-way.

8.0 INTIATION AND COMPLETION OF WORK: Petitioner agrees to notify the District Engineer (and City) or their duly authorized KDOT representative before work is initiated and again when the work is completed.

8.1 An approved signed copy of this Permit shall be on the premises at the start and during the period any work is performed.

8.2 All work, including right-of-way restoration, shall be completed within _____ calendar days of APPROVAL DATE, otherwise this Permit is null and void. The District Engineer or his duly authorized representative may grant an extension of time upon request of Petitioner. Any such request must be submitted in writing and state the reasons for delay in completing the work.

9.0 LIABILITY: Petitioner shall indemnify and hold harmless Secretary from personal injury and property damage claims arising out of any act or omission of Petitioner. If Secretary defends a third party's claim, Petitioner shall indemnify Secretary for personal injury damages, property damages, and related expenses Secretary incurs arising out of Petitioner's act or omission. For purposes of this provision, the term Petitioner includes Petitioner's employees, agents, subcontractors (at any tier), suppliers (at any tier), successors, and assigns.

Void
See Revised Sheet
Rev 12-18

9.1 INSURANCE: Liability Insurance. Petitioner shall carry "General Liability" insurance under an occurrence policy that has a minimum combined single limit of \$2,000,000 for personal injury and property damage and that contains the following coverage: Comprehensive Form, Premises-Operation, Underground Hazard, Products/Completed Operations Hazard, Contractual Insurance, Broad form Property Damage, Independent Contractors, and Personal Injury. Worker's Compensation. Petitioner shall carry "Worker's Compensation and Employer's Liability" insurance that complies with Kansas state law. Automobile Liability. Petitioner shall carry "Automobile Liability" insurance under an occurrence policy that has a minimum combined single limit of \$1,000,000.00 for personal injury and property damage and that contains the following coverage: Comprehensive Form, Owned, Hired, and Non-Owned.

9.2 "Certificate of Insurance". This Permit shall not take effect unless Petitioner provides Secretary a "Certificates of Insurance" confirming Petitioner carries insurance in the amounts and type this section requires. Petitioner shall obtain insurance only from insurers on the approved Federal Treasury List and authorized by the Kansas Commissioner of Insurance. The "Certificates of Insurance" shall include a clause requiring the insurer to notify the Secretary thirty (30) days in advance of a change in or cancellation of the insurance contracts.

9.3 Petitioner shall maintain this insurance until the District Engineer releases Petitioner from any Permit obligation.

10.0 DAMAGE TO UTILITIES: KDOT shall not be liable for damage to any utility not installed in the location authorized by any permit or agreement issued pursuant to the Utility Accommodation Policy.

11.0 PIPELINE LIABILITY: For attachments to bridges or other structures and for roadway crossings of PIPELINES CARRYING PETROLEUM, HAZARDOUS AND/OR CORROSIVE PRODUCTS, Petitioner shall solely assume all risk and liability for accidents and damages that may occur to persons, property or natural resources by reason of the operation of the pipeline attached to the bridge or structure or crossing the roadway.

11.1 Petitioner shall maintain the insurance required in Section 9.0 for as long as the pipeline remains attached to the bridge or other structure or for as long as the pipeline crosses the roadway. The insurance contract shall cover claims for such length of time as the law permits such claims.

12.0 ENVIRONMENTAL LIABILITY AND INDEMNIFICATION: Petitioner shall assume all risk and liability for all claims suits, actions, causes of actions, demands, rights, damages, costs, expenses, penalties, fines or compensation whatsoever, direct or indirect, which Petitioner now has or which Petitioner may have in the future on account of or in any arising out of or in connection with any known or unknown physical or environmental condition of the Petitioner's property or operation. Petitioner shall comply with federal, state and local rules and regulations. These rules include, without limitation, the Toxic Substances Control Act, the Comprehensive Environmental Response, Compensation and Liability Act, the Clean Water Act, the Oil Pollution Act, the Federal Drinking Water Act, the Clean Air Act, the Resource Conservation Recovery Act and all state analogs. Petitioner shall indemnify Secretary against and from all damages, expenses and costs incurred by any person, the State of Kansas, or the United States Government for determining and undertaking investigation, clean-up, removal or remedial action, any fines or penalties assessed under state or federal laws, contract claims, personal injury claims, and damage of or loss of natural resources. For purposes of this provision, the term Petitioner includes Petitioner's employees, agents, subcontractors (at any tier), suppliers (at any tier), successors, and assigns.

13.0 HIGHWAY IMPROVEMENTS: If Secretary makes any alteration or improvement along or upon the highway right-of-way which is the subject of this Permit, Petitioner agrees to hold Secretary harmless for any and all damages or injury to said Petitioner's construction, whether finished or unfinished, as well as damage or injury to Petitioner's equipment, materials, employees, agents or contractees. Within a reasonable time after receiving written notice from Secretary that Petitioner's facilities are in conflict with KDOT's new construction or major maintenance operations, Petitioner shall alter, change location or move their construction work or facilities without cost or expense to the Secretary. If Petitioner fails to relocate their Facilities within a reasonable time, KDOT may designate a time which is not arbitrary or capricious for moving the Facilities. Petitioner shall reimburse KDOT for the costs of relocating the Facilities upon receipt of an itemized statement. (K.S.A. 68-415). In the alternative, Petitioner shall reimburse KDOT for any damages or liabilities or costs to accelerate it may incur as a result of Petitioner's failure to timely relocate the Facility.

13.1 Work approved on this Permit will be conducted in a manner as not to interfere with construction work being performed by KDOT or it's contractors in the vicinity of Petitioner's work or project.

14.0 CANCELLATION: This Permit may be terminated or cancelled by either party upon thirty (30) days written notice to the other party and all rights and privileges accrued to Petitioner under the terms of this Permit shall cease forever, and upon termination or cancellation of this Permit Petitioner shall remove the attachments to the bridge or structure without damage or injury to the bridge or structure. Petitioner shall reimburse the Secretary for any and all damages or injury which results from the removal of attachments to the bridge or structure within thirty (30) days of receipt of an itemized statement of damages.

15.0 ABANDONED OR RETIRED IN PLACE: Petitioner shall notify Secretary when the Facilities will be abandoned or retired in place and shall submit a plan for abandonment or retirement in place to the District Engineer or designee for review and approval. Petitioner shall remove or abandon the Facilities in place in accordance with the approve plan. Petitioner shall pay all costs associated with removal of abandoned or retired in place upon highway right-of-way Facilities.

This Permit is hereby accepted and its provisions agreed to by the parties.

Signature _____

Printed Name _____

Owner _____ Phone _____ Date _____

Street Address (City, State, Zip Code) _____

Agent Lesece Contractor Title _____ Date _____

Street Address (City, State, Zip Code) _____ Contact Email _____

Recommended _____ Date _____ Area/Metro Engr. Area Supt. Utility Coord. _____

Approved _____ Date _____ Bureau of Design-Bridge Section _____

Petmit approved this _____ day of _____, 20_____

SECRETARY OF TRANSPORTATION
OF THE STATE OF KANSAS

BY _____
District Engineer

INDEX

SUBJECT	PAGE
Abandoned Bored Holes	2-12
Aboveground Utilities	2-4/5, 3-1/2
Access for Service - Fully Controlled Access	3-6,7
Access Control	
Full	2-1; 3-1; 4-2
Partial	2-1; 3-3
Addresses - KDOT District and Area Offices	1-9/11
Agreements	
Reimbursable Utility Agreement.....	1-5/6
Utility Permit Agreement.....	i, 1-2,4/6; 3-7/9
Appendix	5-1
Application of Policy - General	i; 1-1
Application for Permits	i; 1-4/7; 3-7/9
Area Offices and Boundaries	1-8/11
As-Built Plans.....	3-5,7
Attachment to Bridges and Other Structures or Installations near Retaining Wall Systems	4-1
Typical Placement.....	4-3/4
Hangers and Clamp Types.....	4-2; 5-8/14
Authority for Policy.....	i
Backfill	1-14,16; 2-2; 3-4,8; 4-2,4,5
Banners	1-18
Bedding Material	2-2
Bond	1-2

INDEX (Continued)

SUBJECT	PAGE
Boring	2-11,12; 4-4
Bridge	
Abutments	4-3, 6
Attachments	1-2,4,6,13; 2-1,2,6; 4-1/ 6; 5-16/21
Attachments (Prohibited).....	3-2; 4-3
Hangers and Clamps	5-22
Brush Control	1-17/18; 3-4
Burning	1-18
Casings	
Encasement	2-7/13; 4-6
Waiver	2-10; 5-35
Uncased Lines	2-10,11
Materials.....	1-6,13; 2-12,13; 3-4
Cathodic Protection.....	1-7,13; 2-10
Cathodic Protection of Pipelines.....	1-7,13; 2-10
Cattle Crossing	1-18
Change In Ownership	1-3,6; 4-2
Chemical Brush Control.....	1-17,18
City Connecting Links.....	i,1-4,6
Cleanup.....	1-16,17
Clearance	
Horizontal.....	2-2/5; 3-3/7
Overhead (Vertical).....	2-2/5; 3-4
Underground	2-6/8; 3-3/6
Clear Zone	1-12,13,18; 2-1,3/6,8; 3-4,5; 5-2,3
Communication Lines	2-5,9; 3-4; 4-6
Construction Projects	i,1-3/5

INDEX (Continued)

SUBJECT	PAGE
Crossing Installation	
Aboveground.....	2-4/5, 3-1
Underground	2-6/8
Definitions	ii
Design of Utility Facility.....	1-13; 3-3,7/8; 4-2/3
Dig Safe	5-4
Discharge of Waste.....	1-3
District Offices and Boundaries	1-8/11
Disturbed Areas	1-14,16; 2-2; 3-4
Drainage Facilities.....	1-1,16; 2-1,3,5,7
Ducts	2-9; 3-4,7
Dummy Permit	1-5
Electric Lines.....	1-1; 2-4/9,13; 4-6
Emergency Maintenance	1-14
Encasement (See Casings)	2-9/11
Environmental Approval.....	3-2/6
Erosion.....	1-14,16,18
Excavation	1-15; 2-2; 4-4
Exceptions to Policy	i; 1-2; 4-2
Exemption - Utilities to Service Highway System.....	1-2; 4-2
Expansion of Facilities	1-13; 3-2,6,8; 4-2
Fee	1-2 3-8
Fencing	1-18; 5-5

INDEX (Continued)

SUBJECT	PAGE
FHWA - Approval.....	i; 1-15
Fiber Optic Cable	1-1; 2-7,9; 3-4
Flaggers.....	1-12
Flower Planting and Landscaping.....	1-19
Form 304 - Use of Highway Right-of-Way.....	1-2,4/6,17; 5-33
Form 308 - Cased Line Utility Wavier	2-10,11; 5-35
Form 310 - Attachment to Bridges, MSE Walls and Other Structures.....	1-2,4/6; 4-1/3; 5-37
Fossil and Rock Hunting.....	1-19
Fully Controlled Access Highways.....	1-2,4/6,13; 2-1,4; 3-1/10; 4-2
Gas Lines	1-1; 2-8/11; 3-1; 4-6
Grain Storage on Mixing Strips and Other KDOT Property.....	1-19
Grout.....	2-12
Hazardous Materials.....	1-6; 2-10; 3-1; 4-1/2,6
Highway Permits	1-4/7; 3-7/9; 4-1/2
Application.....	1-6/67; 3-7/9; 4-1/2
Attachment to Bridges	4-1/2
Connecting Links	i 1-4,5
Forms.....	5-33/38
Standing Permits	1-5,12,14
Index	5-39
Inspection.....	1-7,13,17; 2-3; 3-6
Insurance.....	1-2/6,17; 3-8; 4-1
Joint Use Agreement	3-6

INDEX (Continued)

SUBJECT	PAGE
Interstate Highways (See Fully Controlled Access Highways).....	i; 1-2,5,6,14; 2-1,4,; 3-1/9; 4-2
Landscape and Scenic Enhancement	1-15; 3-4
Liabilities	1-1/8,17; 3-2,8,9; 4-1
Location	
General	1-1; 2-1,4,6
On Access Control - Longitudinal.....	3-1/9
On Structures.....	4-3
Aboveground Installation	2-4,5 3-1,2
Underground Installation	2-6,7,8 3-1,2
Near MSE Walls	2-6, 4-2/6
Mail Box Installation.....	1-19; 5-9
Maintenance and Servicing	1-5,12/16; 2-1,6,11; 3-1/8; 4-1,2,5
Manholes	1-3; 2-6; 3-4; 4-3
Map - KDOT District and Areas.....	1-8
Markers	1-3,6,16; 2-3,7,9,10; 3-5,7
Materials	1-3,6,13,15; 2-2,12,13; 3-4,5; 4-2,5
Monitoring Wells	2-3,4; 5-8
Non-Compliance	1-4; 3-8
Open Trench	2-2,8,9,11,12; 3-8; 4-4
Overhead Utilities (See Aboveground Utilities).....	2-4/5; 3-1/2
Parallel Installations	
Highways	
Aboveground.....	2-1,4/5
Underground	2-1,6/8
Full Control Access Highways	
Aboveground.....	2-4/5; 3-1
Underground	3-1

INDEX (Continued)

SUBJECT	PAGE
Parking of Vehicles and Equipment.....	1-12; 3-4/5
Permit Revocation	1-2
Permits (See Highway Permits)	
Pay Phones at Rest Area.....	1-19
Petroleum Lines.....	2-1,10; 3-1; 4-1,6
Pipeline Installations	i, 1-6,7,13; 2-1,3,9/12, 3-1, 4-1
On Structures.....	3-3 4-1/4
Cathodic Protection.....	1-7,13; 2-10
Near Retaining Wall Systems.....	4-6
Private Utility Lines.....	i; 1-1; 2-1,7
Protection of Traveling Public	1-12; 3-6
References.....	5-1
Reimbursable Utility Agreements.....	1-5,6
Relocation of Utilities	1-1,3,16; 2-1; 3-2; 4-1
Replacement of Facilities	1-3
Restoration of Work Areas.....	1-16/17; 2-2; 3-4
Right-of-Way Corridors	3-2,6
Sanitary Sewer Lines	2-1,10; 4-6
Scenic Enhancement.....	1-15
Seeding	1-16, 3-8
Service Connections	2.5; 3-5
Settlement of Backfill.....	1-14; 3-4,8
Signs	1-12,15; 2-7; 5-23/31

INDEX (Continued)

SUBJECT	PAGE
Slack Lines.....	2-5
Spraying Brush	1-17/18
Standing Permits.....	1-5,12,14
Statutes for Authority	i
Storage of Materials	1-13; 3-5
Structures - Design to Allow Attachments	4-2,3
Sub-Contractors.....	1-1
Surveying.....	1-4,5,16,19; 3-7; 5-13
Telephone Lines	i; 1-1,13; 2-1,5,9; 3-4
Terminate Agreement.....	3-8
Towers	1-1
Traffic Control.....	1-12,13,14,16,18; 2-4; 3-4/8; 5-23/31
Tree Trimming and Spraying	1-18; 3-4
Trenching.....	2-2,8,11,12; 4-4
Tunnels	2-8,11,12
Underground Utilities.....	1-7,13/16; 2-1,4,6/11; 3-1,3,4,5
Underground Utility Damage Prevention Act	1-2; 5-4
Utilities for Highway Operations	1-1; 4-2
Utility Corridor	2-1,5,6; 3-2,3,6
Utility Permit Agreements.....	1-2,4/6; 3-7/9
Vegetation Protection	1-16
Vents	2-3,9

INDEX (Continued)

SUBJECT	PAGE
Vertical Clearance	1-6,16; 2-5; 3-4
Visual Controls	1-15; 3-4
Waiver of Policy	i
Waste Material.....	1-3
Water Lines.....	1-6; 2-11,13; 3-1; 4-6
Welcome Signs, City Owned	1-19; 5-15
Wet Conditions.....	1-14,16; 2-6/8
Work Areas (See Disturbed Areas).....	1-12,14,16
Small Cell Antenna and Tower - Addendum	5-15a